



CUSTOMER SERVICES

Telephone: 09 579 8080 Freefax: 0508 474 800 Fax: 09 579 1166

Email: info@toolware.co.nz

ADMINISTRATION

Nigel Cartwright
Chief Executive Officer
09 526 2520
021 799 120
nigel@toolware.co.nz

Claire Harney
Operations Manager
09 526 2527
021 799 844
claire@toolware.co.nz

Colleen Brady
Systems and Accounts
09 526 2521
09 579 8080
accounts@toolware.co.nz

Aaron Bell
Sales & Marketing Manager
09 526 2522
027 430 6319
aaron@toolware.co.nz

Warren Mosen
Key Accounts Manager
09 526 2528
021 756 349
warren@toolware.co.nz

Denise Mosen
Sales & Marketing Assistant
09 526 2524
021 237 2830
denise@toolware.co.nz

TERRITORY ACCOUNT MANAGERS

Angus Waterhouse
Auckland/Northland
021 0260 2533
angus@toolware.co.nz

Matt Cartwright
Auckland/Hamilton
022 672 6641
matt@toolware.co.nz

Steph Cartwright
Auckland/Coromandel
021 799 620
steph@toolware.co.nz

Ian Hobbis
B.O.P/Waikato/Taranaki/
Whanganui
0274 799 051
ian@toolware.co.nz

Tony Wall
Gisborne/Hawkes Bay/
Manawatu/Wellington
0274 799 053
tony@toolware.co.nz

Mike Litten
Canterbury/Nelson-Marlb/
West Coast
021 799 370
mike@toolware.co.nz

Brad Hands
Canterbury/Otago/Southland
0274 799 061
brad@toolware.co.nz

Connect with us



www.toolware.co.nz



Release: 22/11/2024



ToolWare

NEW ZEALAND'S LEADING WHOLESALE DISTRIBUTOR
THE WORLD'S LEADING HAND TOOL BRANDS



PRODUCT	PAGE	PRODUCT	PAGE	PRODUCT	PAGE
A		Chassis punches	54	Drywall hammers	32
Abrasives	13	Chip brush	14	Drywall saws	83
Acoustic Leak locators	47	Chisels	10	Drywall Square	100
Angle finder	37, 87	Chuck keys	20	Drywall trowels	100
Arbors	74, 77	Circle cutters	12	E	
Asphalt Melter	102	Circlip pliers	44	Ear muff	58
Auger bits	2, 3	Circular saw blades - metal	81	Edgers	98
Aviation snips	84	Circular saw blades - wood	81	Electricians screwdrivers	67-69
Awls	2, 84	Clamps	11	Element Spanner	53
Axes	29	Claw hammers	30	End cutting pliers	44
B		Club hammer	31	Engineers chalk	42
Back saws	83	Cold Chisels	9, 56	Engineers squares	88
Ball pein hammers	32	Combination squares	88	Engravers	66
Band clamps	11	Compass	87	Extensions	2,4,5,20,61
Bandsaw blades	23, 24	Concrete brooms	102	Eye loupes	43
Bar clamps	11	Conical brushes	105	Eyewear Safety	58
Barrier tapes	58	Coping saws	83	Expanders	52
Basin spanners	53	Cork sanding blocks	35	F	
Batteries	66	Corner bead tools	100	Fasty strap ties	41
Battery mounts	25	Corner tools	99, 100	Feeler gauges	87
Bevels	87	Corner trowels	99, 100	Fencing pliers	46
Blind hole bits	5	Counter	89	Fibre cement saw blades	81
Block planes	43	Countersink bits	7	Fibreglass tapes	89
Bolt cutters	8	Crayons	42	Fibro cement cutters	12
Bossing mallets	50	Crimping tools	46, 85	File handles	27
Brick Jointers	98	Cross pein hammers	32	Files	27
Brick tongs	102	Crow bars - Insulated	2, 59	Finishing trowels	94
Brick trowels	93	Crow bars	1, 2	Flame reflectors	53
Bricklayers hammers	31	Cup brushes	105	Flaring tools	52
Broom	59	D		Flat bits	4
Brushes	59, 105	Diamond saw blades	81	Flicker spray	102
Buckets	102	Deburrer	50	Floats	96
Builders Aprons	91	Deck Wrecker	1	Floor scrapers	35
Builders lines	36	Dividers	87	Forstner bits	5
Bull Floats / Parts	97	Diagonal cutting pliers	44	Framing hammers	30
Bungy cords	41	Diameter tapes	89	Fresno trowels	97
C		Diamond drills	12	G	
Cabinet scrapers	35	Displays	110	G clamps	11
Cable cutters	12	Distance meter	40	Gas testing gauges	53
Cable ties	57	Dowel tools	5, 22	Gauging trowels	99
Calipers	87	Drain cleaners	47, 48	Gear pullers	46
Caravan levels	37	Drain rods / attachments	48	Gas torch	53
Carbide tipped hole cutters	77	Drain Test plugs	49	Glass cutters	12
Carpenters wood mallet	32	Drill accessories	20	Glass drill bits	12
Caulking guns	41	Drill bits (HSS)	15-16	Gloves	58
Cementers trowels	95	Drill bits (masonry)	17-18	Gluing clamps	1
Centre punches	56	Drill bit sets	19	Gold pans	28
Chain wrenches	103, 106, 107	Drill chucks - keyless	20	Groove joint pliers	45
Chainsaw files	27	Drill press vices	104	Groovers	98
Chalk line chalk	36	Drill powered pump	20	Grout bag	102
Chalk lines	36	Dry ice set	48		

PRODUCT	PAGE	PRODUCT	PAGE	PRODUCT	PAGE
H		Mapp gas	53	Pincers	46
Hacksaws	82	Marking gauges	87	Pipe clamp	11
Hammers	30-33	Masonry brush	102	Pipe cutters	51
Hammer handles	32	Masonry chisels	9	Pipe extractors	50
Hand nibblers	84	Masonry cutting disk	13	Pipe freezer kit	48
Handy bar	1	Masonry drills	17-18	Pipe saws	53
Hatchets	29	Masonry SDS drills	18	Pipe wrenches	107
Head lamp	66	Measuring ropes	89	Planes	43
Hex keys	70, 72	Measuring tapes	89, 90	Planer blades	80
Hole cutter	12, 77	Metal cutting disk	13	Plastering hawk	93
Holesaws	73-78	Metal nibbling cutters	20, 84	Plastic floats	96
Hollow punch	54	Metal shears	84, 85	Plier punch	46
Honing gauges	87	Metal snips	84, 85	Plug cutters	7
HSS Twist drill sets	19	Mirrors	43	Plumb bobs	36
HSS Twist drill bits	15, 16, 19	Mitre boxes	42	Plumbers mirrors	43
I		Mitre protractor	87	Plumbers spanners	53
Internal pipe cutter	53	Mixers	102	Pneumatic tool bits	104, 108
Inspection cameras	47	Moisture meter	40	Pliers	44-46
Inspection mirrors	43	Morse taper sleeves	20	Plungers	48
Insulated crow bar	2	Mortice gauge	87	Pocket cutters	8
J		Mounting	25, 26	Pointing trowels	99
Jab saw	83	Mud pans	100	Pole sanders	100
Jewellers screwdrivers	69	Multi tool blades	81	Pool trowels	94
Jewellers shears	85	Multi tools	45	Post hole digger	59
Jigsaw blades	79, 80	N		Post levels	37
Jointers	98	Nail bags	91	Probing spears	59
K		Nail bars	1	Profile gauges	87
Knee pads	58	Nail bitters	3	Protractors	87
Kneeler board	58	Nail puller	46	Pry bars	1, 108
Knives	34	Nail punches	56	Pull crete	97
L		Needle files	27	Punch and die sets	54-56
Lanterns / lamps	66	Nibblers	84	Punch pliers	46
Lead dressing tools	50	Nipple cutters	53	Putty knives	101
Leak detection	47	Notch spreader	101	Q	
LED flashlights	66	Notch trowel	101	Quick chucks	65
Letter punches	54	Number punches	54	Quick drive bits	63
Lights	66	Nut setters	60, 62, 64,69	R	
Line laser levels	39	O		Rafter squares	88
Line levels	37	Offset screwdrivers	69	Rakes	59
Levels	37, 38	Oil cans	41	Rasps	27
Linesman's pliers	44	Oil stones	13	Ratchet screwdrivers	69
Locking pliers	103	Oscillating multi tool blade	81	Ratchet tiedown	41
Long nose pliers	44	Oxygen gas bottles	53	Ratchet wrenches	108
M		P		Reamers	50
Machete	29	Paint scrapers	35	Rebar scanner	40
Magnesium floats	96	Pan screw remover	53	Rebate planes	43
Magnetic bit screwdrivers	69	Pencils	42	Reciprocating saw blades	79
Magnetic clamps	14	Permanent Markers	42	Reduced shank drills	15-16
Magnifiers	43	Pick-up tools	43	Ring and open end spanners	108
Mallets	32-33	Pilot drills	74	Ring spanners	108
Manhole lifters	59	Pin setting tool	2	Rivet setting punches	56

PRODUCT	PAGE	PRODUCT	PAGE	PRODUCT	PAGE
Rivet tools	14	Spray gun	102	Trowel handles	97
Rock picks	28	Squares	88	Trowels	93-100
Rod cutter benders	8	Stair gauges	87	Try squares	88
Root clearing system	47	Staple guns	21	Tube benders	52
Rope / String	36	Staples	21	Tube cutters	51
Router bits	6	Steel rules	86	Tube expanders	52
Rubber bucket	102	Steel tapes	89	Tube spanners	53
Rubber floats	96	Step drill	16	Turbo shears	85
Rubbing bricks	13	Straight edges	86, 100	Twine	36
Rules and gauge	86, 87	Strap cutters	12	U	
S		Strap wrenches	107	-	
Safety goggles	58	String / String line	36	V	
Safety helmet	58	Stripping knives	35	Veneer clamps	11
Sanders	100	Stud finders	40	Vices / Vice Parts	104
Sanding block	35	Stud fixing tool	85	Voltage tester	40, 68
Sash bar cramps	11	Stud punch out tool	53	W	
Saws	83, 100	Suction lifters	46	Wad punches	54
Sawhorses	11	Surform files / Blades	28	Walking measures	89
Scarifiers	99	Surveyors ropes	89	Wall board saw	83
Score and snap knives	12	Swaging tools	52	Water levels	38
Scrapers	35	T		Welders clamps	11
Scratch awls	2, 84	T-Bar cramps	11	Welding hammers	32
Screeds	101	Tables	11	Window scrapers	35
Screw extractors	69	Tack lifters	46	Window trowels	98
Screwdrivers / Sets	67-69	Tap re-seat tools	50	Wing compasses	87
Screwdriver bit sets	60-65	Tap socket sets	53	Wipes	28
Screwdriver bits - bulk	63-65	Tap spanner	53	Wire brush	105
Screwdriver bits - carded	60-65	Tap wrenches	50	Wire and cable Staplers	21
Screwdrivers Precision	69	Tape Measures	89-90	Wire stripping pliers	46
Scribers	42	Taper files	27	Wire tie drillers	14
Scutch hammer	31	Taper punches	55	Wire wheels	105
Self feed wood bits	5	Tee extractor	50	Wood chisels	10
Sharpening/Oil stone	13	Test plugs	49	Wood floats	96
Shovels / handles	59	Test pump	49	Wood joining biscuits	22
Side cutter	44	Texturing guns	102	Wood mallets	32
Sledge hammers	31	Thermometer	50	Work lamps / lights	66
Sliding bevel	87	Thread inserting tools	14	Worktable	11
Snap-Off knives / blades	34	Threaded rod cutters	8	Wrecking bars	1
Snips	85	Tile cutters	12, 78	Wrenches	106-107
Socket accessories	109, 61	Tile drill bits	12	X	
Socket adaptors	61	Tile grouters floats	96	-	
Socket sets	109	Tin snips	85	Y	
Socket wrenches	109	Tool bags	92	-	
Soft face hammers	33	Tool belts	91-92	Z	
Soldering mat	53	Tool boxes	92	-	
Spades / handles	59	Tool chests	92		
Spanners	106, 108	Tool holders	91		
Speed clamps	11	Tool mounts	25		
Speed squares	88	Torches	66		
Spokeshaves	43	Torpedo levels	37		
Sponge	96	Trammel points	87		

1			
NAIL BARS:			length
DG210	DOGYU	Black Pro Claw nail bar and puller - Japanese pattern	210mm
DG250	DOGYU	Black Pro Claw nail bar and puller - Japanese pattern	250mm
DG300	DOGYU	Black Pro Claw nail bar and puller - Japanese pattern	300mm
DG360	DOGYU	Black Pro Claw nail bar and puller - Japanese pattern	360mm
E-PCG210	ESTWING	Alloy Pro Claw bar and nail puller - Japanese pattern	210mm
E-PCG250	ESTWING	Alloy Pro Claw bar and nail puller - Japanese pattern	250mm
E-PCG300	ESTWING	Alloy Pro Claw bar and nail puller - Japanese pattern	300mm
E-PCG360	ESTWING	Alloy Pro Claw bar and nail puller - Japanese pattern	360mm
E-MPG300	ESTWING	Alloy Pro Claw moulding puller - wide blade pattern	300mm
DGMP150	DOGYU	Pro Claw moulding puller - wide blade pattern	
DGMP200	DOGYU	Pro Claw moulding puller - wide blade pattern	
E-HB15	ESTWING	Handy bar	375mm
E-HB21	ESTWING	Handy bar	530mm
E-HC10	ESTWING	Handy Claw	250mm
E-RSC	ESTWING	Pry Master bar - wide blade Japanese pattern	380mm
MA41300	MAYHEW	Handy bar	350mm
ST515	STANLEY	Wonder bar	325mm
MA98602	MAYHEW	Mini Utility Bar	190mm
PRY BARS:			
E-PB18	ESTWING	Offset Pry bar	450mm
MA40100	MAYHEW	Rolling head pry bar	225mm
MA40101	MAYHEW	Rolling head pry bar	400mm
MA40102	MAYHEW	Rolling head pry bar	450mm
MA40104	MAYHEW	Rolling head pry bar	550mm
MA40000	MAYHEW	Line up pry bar	350mm
MA40001	MAYHEW	Line up pry bar	400mm
MA40002	MAYHEW	Line up pry bar	500mm
MA40003	MAYHEW	Line up pry bar	600mm
MA40022	MAYHEW	Line up pry bar	950mm
MA75004	MAYHEW	Line up pry bar	750mm
MA49000	MAYHEW	Alloy line up pry bar	375mm
MA49001	MAYHEW	Alloy line up pry bar	475mm
MA49003	MAYHEW	Alloy line up pry bar	625mm
MA49004	MAYHEW	Alloy line up pry bar	750mm
MA61306	MAYHEW	Line up pry bar set of 3 Contains: <i>1x 350mm & 500mm Line-up pry bar</i> <i>1x 400mm Rolling head pry bar</i>	
MA40150	MAYHEW	Lady foot pry bar	300mm
MA40152	MAYHEW	Lady foot pry bar	400mm
MA40154	MAYHEW	Lady foot pry bar	525mm
MA60144	MAYHEW	Dominator curved screwdriver pry bar - capped end	425mm
MA60146	MAYHEW	Dominator curved screwdriver pry bar - capped end	625mm
MA60148	MAYHEW	Dominator curved screwdriver pry bar - capped end	775mm
MA40162	MAYHEW	Dominator curved screwdriver pry bar - capped end	1450mm
MA60150	MAYHEW	Ladyfoot pry bar set - 300mm, 400mm, 525mm	Set of 3
MA61355	MAYHEW	Dominator curved screwdriver pry bar	Set of 3
MA40111	MAYHEW	Screwdriver pry bar	420mm
MA41280	MAYHEW	Die separation bar	450mm
MA76295	MAYHEW	Pro utility pry bar set of 4 - tray Contains: <i>1x 725mm Capped end pry bar, 1x 400mm Line-up pry bar</i> <i>1x 400mm Ladyfoot pry bar, 1x Mini utility pry bar</i>	
E-PB3PC	ESTWING	Pry bar set of 3	138mm, 188mm, 254mm
ST55-102	STANLEY	Fatmax Extreme wrecking bar	610mm
ST55-104	STANLEY	Fatmax Extreme wrecking bar	910mm
WRECKING BARS:			
E-EWB12	ESTWING	Wrecking bar - heavy duty forged steel	300mm
E-EWB18	ESTWING	Wrecking bar - heavy duty forged steel	450mm
E-EWB24	ESTWING	Wrecking bar - heavy duty forged steel	600mm
E-EWB30	ESTWING	Wrecking bar - heavy duty forged steel	750mm
E-EWB36	ESTWING	Wrecking bar - heavy duty forged steel	900mm
MA41104	MAYHEW	Pro - Deck wrecking bar	1100mm



E-PCG300
Nail bar



DG300
Nail bar



E-HC10
Handy claw



E-RSC
Pry Master



E-MPG300
Moulding puller



E-PB18
Offset pry bar



DGMP200
Moulding puller



E-HB15
Handy bar



MA40111
Screwdriver bar



MA41300
Handy bar



MA41280
Die separation bar



MA40102
Rolling head pry bar



ST55-102
Fatmax wrecking bar



MA40152
Lady foot pry bar



E-EWB24
Wrecking bar



MA40001
Line up pry bar



MA41104
Deck wrecker



MA49001
Alloy Line up pry bar



MA76295
Pry bar set



MA61306
Pry bar set



E-PB3PC
Pry bar set

CROW BARS
Length

TW9001	STANWAY	Chisel and point crow bar - 30mm hex section	1200mm
TW9009	STANWAY	Chisel and point crow bar - 30mm hex section	1750mm
TW9025	STANWAY	Chisel and point crow bar - 25mm hex section	1750mm
FAICROW60-INS	FAITHFULL	1000v insulated crowbar - 30mm hex section	1750mm

COMBINATION AUGER BITS
Diameter
Length
Shank
Shank Shape

SM6-06	STAR M	Combination Auger Bit - Standard	6mm	160mm	6.35mm	Hex
SM6-08	STAR M	Combination Auger Bit - Standard	8mm	170mm	6.35mm	Hex
SM6-09	STAR M	Combination Auger Bit - Standard	9mm	180mm	6.35mm	Hex
SM6-10	STAR M	Combination Auger Bit - Standard	10mm	190mm	6.35mm	Hex
SM6-11	STAR M	Combination Auger Bit - Standard	11mm	190mm	6.35mm	Hex
SM6-12	STAR M	Combination Auger Bit - Standard	12mm	190mm	6.35mm	Hex
SM6-13	STAR M	Combination Auger Bit - Standard	13mm	190mm	6.35mm	Hex
SM6-14	STAR M	Combination Auger Bit - Standard	14mm	200mm	10mm	Hex
SM6-15	STAR M	Combination Auger Bit - Standard	15mm	200mm	10mm	Hex
SM6-16	STAR M	Combination Auger Bit - Standard	16mm	200mm	10mm	Hex
SM6-17	STAR M	Combination Auger Bit - Standard	17mm	200mm	10mm	Hex
SM6-18	STAR M	Combination Auger Bit - Standard	18mm	200mm	10mm	Hex
SM6-19	STAR M	Combination Auger Bit - Standard	19mm	200mm	10mm	Hex
SM6-20	STAR M	Combination Auger Bit - Standard	20mm	210mm	10mm	Hex
SM6-21	STAR M	Combination Auger Bit - Standard	21mm	210mm	10mm	Hex
SM6-22	STAR M	Combination Auger Bit - Standard	22mm	210mm	10mm	Hex
SM6-24	STAR M	Combination Auger Bit - Standard	24mm	210mm	10mm	Hex
SM6-25	STAR M	Combination Auger Bit - Standard	25mm	210mm	10mm	Hex
SM6-28	STAR M	Combination Auger Bit - Standard	28mm	210mm	10mm	Hex
SM6-29	STAR M	Combination Auger Bit - Standard	29mm	210mm	10mm	Hex
SM6-30	STAR M	Combination Auger Bit - Standard	30mm	210mm	10mm	Hex
SM6-32	STAR M	Combination Auger Bit - Standard	32mm	210mm	12mm	Hex
SM6-35	STAR M	Combination Auger Bit - Standard	35mm	210mm	12mm	Hex
SM6-38	STAR M	Combination Auger Bit - Standard	38mm	210mm	12mm	Hex

NAIL BITER SHIP AUGERS
Diameter
Length
Shank
Shank Shape

SM7-20	STAR M	Nail Biter Ship Auger - Short	20mm	190mm	12.5mm	Hex
SM7-22	STAR M	Nail Biter Ship Auger - Short	22mm	190mm	12.5mm	Hex
SM7-25	STAR M	Nail Biter Ship Auger - Short	25mm	190mm	12.5mm	Hex
SM8P-20	STAR M	Nail Biter Ship Auger - Long	20mm	457mm	12.5mm	Hex
SM8P-22	STAR M	Nail Biter Ship Auger - Long	22mm	457mm	12.5mm	Hex
SM8P-25	STAR M	Nail Biter Ship Auger - Long	25mm	457mm	12.5mm	Hex

EXTENSIONS:

MR12E	MORSE	Extension bar for power tool bits with a 1/2" (13mm) shank	300mm
-------	-------	--	-------

AWLS:
blade length

GN818	GENERAL	Scratch awl - tang thru blade	90mm
DRPST	DRAPER	Pin setting tool	

CROW BARS

TW9001
Chisel & Point (30mm hex)



TW9009
Chisel & Point (30mm hex)



TW9025
Chisel & Point (25mm hex)



FAICROW60-INS
Insulated Crow Bar

AWLS

GN818
Scratch Awl



DRPST
Pin setting tool

EXTENSIONS

MR12E
300mm length for 1/2" shank

COMBINATION AUGER BIT

SM6 Series: 6mm - 38mm

Use with: Electric drill, Cordless drill (14.4V Min), or a quick change impact driver (only on sizes 6-13mm).

**NAIL BITER SHIP AUGERS**

SM7 (Short) & SM8P (Long) Series: 20mm, 22mm, 25mm

Use with: Electric power drill.

For drilling into nail-embedded wood.



3				Diameter	Length	Shank	Shank Shape
POWER AUGER BITS							
SM4-06	STAR M	Power Auger Bit - Standard		6mm	210mm	5.7mm	Round
SM4-08	STAR M	Power Auger Bit - Standard		8mm	225mm	7mm	Hex
SM4-10	STAR M	Power Auger Bit - Standard		10mm	250mm	7mm	Hex
SM4-12	STAR M	Power Auger Bit - Standard		12mm	270mm	10mm	Hex
SM4-13	STAR M	Power Auger Bit - Standard		13mm	270mm	10mm	Hex
SM4-14	STAR M	Power Auger Bit - Standard		14mm	290mm	10mm	Hex
SM4-16	STAR M	Power Auger Bit - Standard		16mm	290mm	10mm	Hex
SM4-18	STAR M	Power Auger Bit - Standard		18mm	330mm	10mm	Hex
SM4-19	STAR M	Power Auger Bit - Standard		19mm	330mm	10mm	Hex
SM4-20	STAR M	Power Auger Bit - Standard		20mm	330mm	12mm	Hex
SM4-22	STAR M	Power Auger Bit - Standard		22mm	330mm	12mm	Hex
SM4-24	STAR M	Power Auger Bit - Standard		24mm	330mm	12mm	Hex
SM4-25	STAR M	Power Auger Bit - Standard		25mm	330mm	12mm	Hex
SM4-28	STAR M	Power Auger Bit - Standard		28mm	330mm	12mm	Hex
SM4-32	STAR M	Power Auger Bit - Standard		32mm	330mm	12mm	Hex
SM4-35	STAR M	Power Auger Bit - Standard		35mm	330mm	12mm	Hex
SM4-38	STAR M	Power Auger Bit - Standard		38mm	330mm	12mm	Hex
SM400-06	STAR-M	Power Auger Bit - 400mm Long		6mm	400mm	5.7mm	Round
SM400-08	STAR-M	Power Auger Bit - 400mm Long		8mm	400mm	8mm	Hex
SM400-10	STAR M	Power Auger Bit - 400mm Long		10mm	400mm	10mm	Hex
SM400-12	STAR M	Power Auger Bit - 400mm Long		12mm	400mm	10mm	Hex
SM400-13	STAR M	Power Auger Bit - 400mm Long		13mm	400mm	10mm	Hex
SM400-14	STAR M	Power Auger Bit - 400mm Long		14mm	400mm	12mm	Hex
SM400-16	STAR M	Power Auger Bit - 400mm Long		16mm	400mm	12mm	Hex
SM400-18	STAR M	Power Auger Bit - 400mm Long		18mm	400mm	12mm	Hex
SM400-19	STAR M	Power Auger Bit - 400mm Long		19mm	400mm	12mm	Hex
SM400-20	STAR M	Power Auger Bit - 400mm Long		20mm	400mm	12mm	Hex
SM400-21	STAR M	Power Auger Bit - 400mm Long		21mm	400mm	12mm	Hex
SM400-22	STAR M	Power Auger Bit - 400mm Long		22mm	400mm	12mm	Hex
SM400-24	STAR M	Power Auger Bit - 400mm Long		24mm	400mm	12mm	Hex
SM400-25	STAR M	Power Auger Bit - 400mm Long		25mm	400mm	12mm	Hex
SM400-28	STAR M	Power Auger Bit - 400mm Long		28mm	400mm	12mm	Hex
SM400-32	STAR M	Power Auger Bit - 400mm Long		32mm	400mm	12mm	Hex
SM400-35	STAR M	Power Auger Bit - 400mm Long		35mm	400mm	12mm	Hex
SM400-38	STAR M	Power Auger Bit - 400mm Long		38mm	400mm	12mm	Hex
SM500-10	STAR M	Power Auger Bit - 500mm Long		10mm	500mm	10mm	Hex
SM500-12	STAR M	Power Auger Bit - 500mm Long		12mm	500mm	10mm	Hex
SM500-13	STAR M	Power Auger Bit - 500mm Long		13mm	500mm	10mm	Hex
SM500-14	STAR M	Power Auger Bit - 500mm Long		14mm	500mm	12mm	Hex
SM500-16	STAR M	Power Auger Bit - 500mm Long		16mm	500mm	12mm	Hex
SM500-18	STAR M	Power Auger Bit - 500mm Long		18mm	500mm	12mm	Hex
SM500-19	STAR M	Power Auger Bit - 500mm Long		19mm	500mm	12mm	Hex
SM500-20	STAR M	Power Auger Bit - 500mm Long		20mm	500mm	12mm	Hex
SM500-21	STAR M	Power Auger Bit - 500mm Long		21mm	500mm	12mm	Hex
SM500-22	STAR M	Power Auger Bit - 500mm Long		22mm	500mm	12mm	Hex
SM500-24	STAR M	Power Auger Bit - 500mm Long		24mm	500mm	12mm	Hex
SM500-25	STAR M	Power Auger Bit - 500mm Long		25mm	500mm	12mm	Hex
SM500-28	STAR M	Power Auger Bit - 500mm Long		28mm	500mm	12mm	Hex
SM500-30	STAR M	Power Auger Bit - 500mm Long		30mm	500mm	12mm	Hex
SM500-32	STAR M	Power Auger Bit - 500mm Long		32mm	500mm	12mm	Hex
SM500-35	STAR M	Power Auger Bit - 500mm Long		35mm	500mm	12mm	Hex
SM500-38	STAR M	Power Auger Bit - 500mm Long		38mm	500mm	12mm	Hex
SM600-12	STAR M	Power Auger Bit - 600mm Long		12mm	600mm	10mm	Hex
SM600-13	STAR M	Power Auger Bit - 600mm Long		13mm	600mm	10mm	Hex
SM600-16	STAR M	Power Auger Bit - 600mm Long		16mm	600mm	12mm	Hex
SM600-19	STAR M	Power Auger Bit - 600mm Long		19mm	600mm	12mm	Hex
SM600-20	STAR M	Power Auger Bit - 600mm Long		20mm	600mm	12mm	Hex
SM600-22	STAR M	Power Auger Bit - 600mm Long		22mm	600mm	12mm	Hex
SM600-25	STAR M	Power Auger Bit - 600mm Long		25mm	600mm	12mm	Hex



**POWER AUGER BIT
600MM LONG**

SM4 Series: 12mm - 25mm
Use with: Electric power drill.



**POWER AUGER BIT
500MM LONG**

SM500 Series: 10mm - 38mm
Use with: Electric power drill.

**POWER AUGER BIT
400MM LONG**

SM400 Series: 6mm - 38mm
Use with: Electric power drill.



**POWER AUGER BIT
STANDARD**

SM4 Series: 6mm - 38mm
Use with: Electric power drill.



FLAT POWER BITS:				diameter	total length
DRFB06	DRAPER	Flat power bit with cutting spurs		6.0mm	152mm
DRFB08	DRAPER	Flat power bit with cutting spurs		8.0mm	152mm
DRFB10	DRAPER	Flat power bit with cutting spurs		10.0mm	152mm
DRFB12	DRAPER	Flat power bit with cutting spurs		12.0mm	152mm
DRFB13	DRAPER	Flat power bit with cutting spurs		13.0mm	152mm
DRFB14	DRAPER	Flat power bit with cutting spurs		14.0mm	152mm
DRFB16	DRAPER	Flat power bit with cutting spurs		16.0mm	152mm
DRFB18	DRAPER	Flat power bit with cutting spurs		18.0mm	152mm
DRFB19	DRAPER	Flat power bit with cutting spurs		19.0mm	152mm
DRFB20	DRAPER	Flat power bit with cutting spurs		20.0mm	152mm
DRFB22	DRAPER	Flat power bit with cutting spurs		22.0mm	152mm
DRFB24	DRAPER	Flat power bit with cutting spurs		24.0mm	152mm
DRFB25	DRAPER	Flat power bit with cutting spurs		25.0mm	152mm
DRFB28	DRAPER	Flat power bit with cutting spurs		28.0mm	152mm
DRFB30	DRAPER	Flat power bit with cutting spurs		30.0mm	152mm
DRFB32	DRAPER	Flat power bit with cutting spurs		32.0mm	152mm
DRFB35	DRAPER	Flat power bit with cutting spurs		35.0mm	152mm
DRFB38	DRAPER	Flat power bit with cutting spurs		38.0mm	152mm
FLAT POWER BITS - EXTRA LONG:				Diameter	total length
DRFBXL-10	DRAPER	Extra long flat power bit with cutting spurs		10.0mm	405mm
DRFBXL-16	DRAPER	Extra long flat power bit with cutting spurs		16.0mm	405mm
DRFBXL-19	DRAPER	Extra long flat power bit with cutting spurs		19.0mm	405mm
DRFBXL-20	DRAPER	Extra long flat power bit with cutting spurs		20.0mm	405mm
DRFBXL-22	DRAPER	Extra long flat power bit with cutting spurs		22.0mm	405mm
DRFBXL-25	DRAPER	Extra long flat power bit with cutting spurs		25.0mm	405mm
FLAT POWER BIT EXTENSIONS:				flat bit sizes in sets	
GFB348	GFB	Universal magnetic bit holder		150mm x 12.0mm	
GFB456	GFB	Universal magnetic bit holder		200mm x 12.0mm	
FLAT POWER BIT SETS:				flat bit sizes in sets	
DRFBSET6	DRAPER	Flat power bit with cutting spurs - Set of 5		13.0mm, 16.0mm, 20.0mm, 22.0mm, 25.0mm, 32.0mm	

STANDARD SIZE FLAT BITS

EXTRA LONG FLAT BITS



DRFB10
10mm



DRFB13
13mm



DRFBXL-10
10mm



DRFB18
18mm



DRFB19
19mm

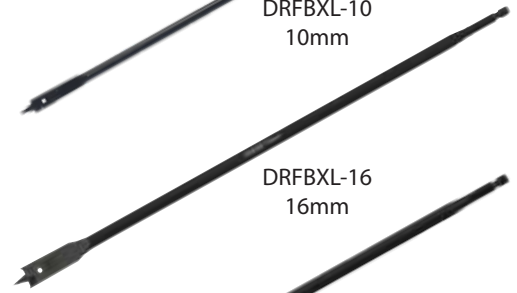

DRFBXL-16
16mm



DRFB22
22mm



DRFB25
25mm



DRFBXL-19
19mm



DRFB32
32mm



DRFB38
38mm

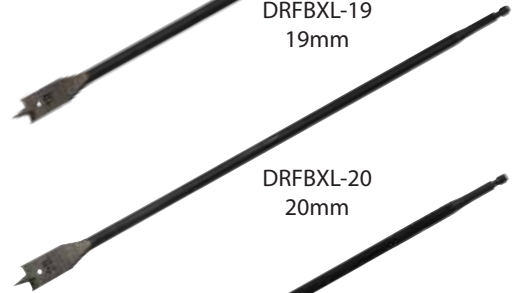

DRFBXL-20
20mm

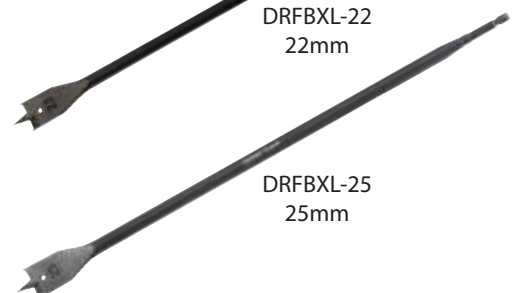

DRFBXL-22
22mm



DRFB16
16mm



DRFB20
20mm



DRFB28
28mm



GFB456
Mag. bit holder



GFB348
Mag. bit holder



DRFBSET6
6 Piece Bit Set
(13, 16, 20, 22, 25, 32mm)

SELF-FEED WOOD BITS:
Size

DW3-25	DEWALT	Self Feed Drill Bit	25.0mm
DW3-28	DEWALT	Self Feed Drill Bit	28.0mm
DW3-32	DEWALT	Self Feed Drill Bit	32.0mm
DW3-35	DEWALT	Self Feed Drill Bit	35.0mm
DW3-38	DEWALT	Self Feed Drill Bit	38.0mm
DW3-45	DEWALT	Self Feed Drill Bit	45.0mm
DW3-51	DEWALT	Self Feed Drill Bit	51.0mm
DW3-54	DEWALT	Self Feed Drill Bit	54.0mm
DW3-57	DEWALT	Self Feed Drill Bit	57.0mm
DW3-65	DEWALT	Self Feed Drill Bit	65.0mm
DW3-76	DEWALT	Self Feed Drill Bit	76.0mm
DW3-92	DEWALT	Self Feed Drill Bit	92.0mm
DW3-117	DEWALT	Self Feed Drill Bit	117.0mm
DW3-EXT140	DEWALT	Self Feed Drill Extension Bit	140mm
DW3-SET8	DEWALT	Heavy Duty Self Feed Drill Bit Set <i>Contains: 25mm, 28mm, 32mm, 38mm, 45mm, 54mm, 65mm & 11mm Quick Change Shank</i>	8pc

HINGE BORING END MILL BITS:

PG382-00	PG	Hinge sinker - high speed steel cutters	35mm
PG384-20	PG	Super end mill - tungsten carbide cutters	35mm

DOWEL BITS:

PG630-06	PG	Dowel woodwork bit - flush cutting	6mm
PG630-08	PG	Dowel woodwork bit - flush cutting	8mm
PG630-10	PG	Dowel woodwork bit - flush cutting	10mm
PG630-12	PG	Dowel woodwork bit - flush cutting	12mm



PG630-06
Dowel bit



PG630-08
Dowel bit



DW3-EXT140
140mm extension



MR12E
300mm extension



PG630-10
Dowel bit



PG630-12
Dowel bit



DW3-38
38mm Self Feed Bit



DW3-65
65mm Self Feed Bit



PG384-20
Super end mill



PG382-00
Hinge Boring

6		ECONOCUT ROUTER BITS:					
		Diameter A	Cutting Length B	Length C	Radius R	Shank Inch / mm	
EY206M	Straight Bit	6mm	16mm	46.7mm	---	1/4" (6.35)	
EY208M	Straight Bit	8mm	20mm	51.7mm	---	1/4" (6.35)	
EY210M	Straight Bit	10mm	20mm	51.7mm	---	1/4" (6.35)	
EY212M	Straight Bit	12mm	20mm	51.7mm	---	1/4" (6.35)	
EY213M	Straight Bit	13mm	20mm	51.7mm	---	1/4" (6.35)	
EY216M	Straight Bit	16mm	20mm	51.7mm	---	1/4" (6.35)	
EY218M	Straight Bit	18mm	20mm	51.7mm	---	1/4" (6.35)	
EY219M	Straight Bit	19mm	20mm	51.7mm	---	1/4" (6.35)	
EY8012B	Flush Trim Bit with Bearing Guide	9.5mm	12.7mm	54mm	---	1/4" (6.35)	
EY8016B	Flush Trim Bit with Bearing Guide	12.7mm	13mm	56mm	---	1/4" (6.35)	
EY416	Core Box Bit	12.7mm	9.5mm	40mm	6.35mm	1/4" (6.35)	
EY424	Core Box Bit	19mm	12.7mm	47mm	9.5mm	1/4" (6.35)	
EY5705B	Roman Ogee Bit with Bearing Guide	25.5mm	13mm	52mm	4mm	1/4" (6.35)	
EY5708B	Roman Ogee Bit with Bearing Guide	34.9mm	19mm	60.3mm	6.35mm	1/4" (6.35)	
EY712B	Cove Bit with Bearing Guide	28.5mm	12.7mm	53mm	9.5mm	1/4" (6.35)	
EY716B	Cove Bit with Bearing Guide	34.9mm	15.9mm	57.1mm	12.7mm	1/4" (6.35)	
EYC8B	Classical Bit with Bearing Guide	28.5mm	12.7mm	50.8mm	3.2mm	1/4" (6.35)	
EYC12B	Classical Bit with Bearing Guide	35mm	15.9mm	57mm	4.8mm	1/4" (6.35)	
EY508B	Rounding Over Bit with Bearing Guide	25.4mm	13.5mm	52mm	6.35mm	1/4" (6.35)	
EY510B	Rounding Over Bit with Bearing Guide	28.5mm	15.5mm	28.5mm	7.9mm	1/4" (6.35)	
EY512B	Rounding Over Bit with Bearing Guide	31.8mm	16.5mm	56mm	9.5mm	1/4" (6.35)	
EY516B	Rounding Over Bit with Bearing Guide	38.1mm	19mm	60.3mm	12.7mm	1/4" (6.35)	
EY608B	Beading Bit with Bearing Guide	25.4mm	13.5mm	52mm	6.35mm	1/4" (6.35)	
EY610B	Beading Bit with Bearing Guide	28.5mm	15.5mm	56mm	7.9mm	1/4" (6.35)	
EY612B	Beading Bit with Bearing Guide	31.8mm	16.5mm	56mm	9.5mm	1/4" (6.35)	
					Angle		
EY112	V-Groove Bit	12.7mm	12.7mm	45mm	90°	1/4" (6.35)	
EY916B	Chamfering Bit with Bearing Guide	32mm	15mm	55mm	45°	1/4" (6.35)	
ECONOCUT BALL BEARING GUIDES:				Outer Diameter	Inner Diameter	Depth B	
EYB1	Ball Bearing Guide			16mm	5mm	5mm	
EYB4	Ball Bearing Guide			12.7mm	4.8mm	4.8mm	
ECONOCUT ROUTER BIT SETS:					Quantity	Shank Inch / mm	
EY06SET	Starter Router Bit Set <i>Contains: 3x Straight, 1x Core Box, 1x Rounding Over, 1x Roman Ogee Bits</i> <i>Bonus: 1 x EZE-LAP™ Diamond Hone & Stone Sharpener</i>				6pc	1/4" (6.35)	
6TBUD-12	Handyman Router Bit Kit <i>Contains: 3x Straight, 1x Core Box, 1x Core Box, 1x Dovetail, 1x V-Groove</i> <i>1x Flush Trim, 2x Rounding Over, 1x Cove, 1x Chamfering, 1x Roman Ogee Bits</i>				12pc	1/4" (6.35)	
T-CUT (CARBITOOL) ROUTER BITS:							
<i>Full details on the T-Cut / Carbitool router bit and cutting tool range are listed in the Carbitool catalogue which is available on request.</i>							

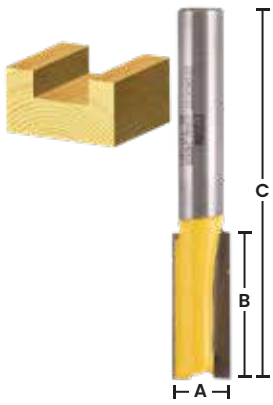

Straight Bit

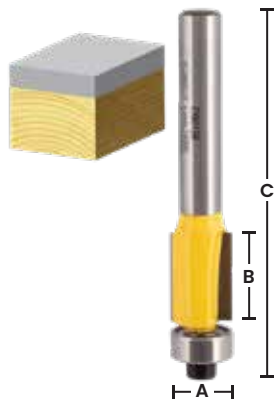

Flush Trim Bit

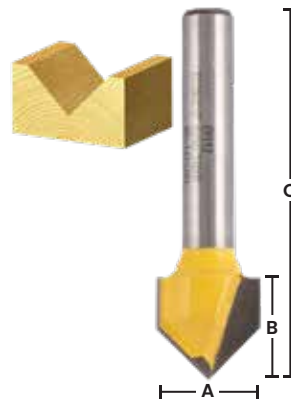

V-Groove Bit

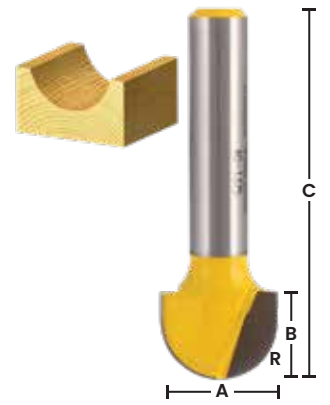

Core Box Bit

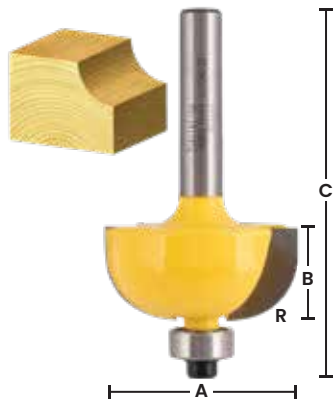

Cove Bit

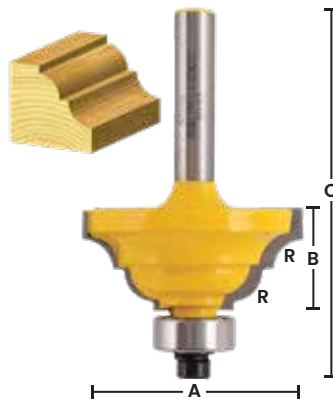

Classical Bit

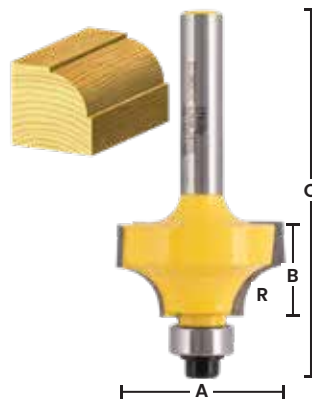

Beading Bit

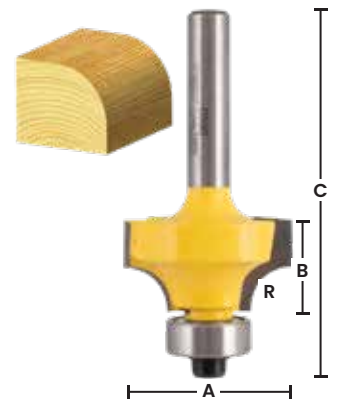

Rounding Over Bit

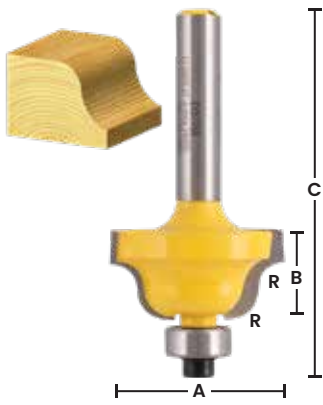

Roman Ogee Bit

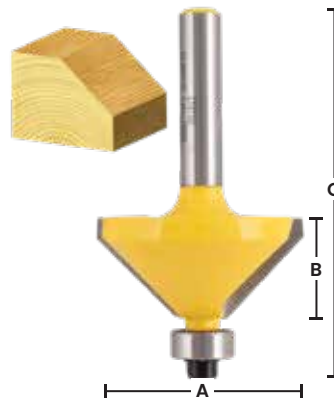

Chamfering Bit

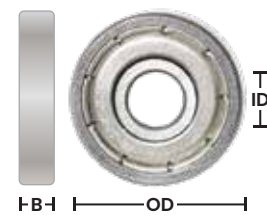

Ball Bearing Guide



EY06SET
Router bit set - 6 pc



6TBUD-12
Router bit set - 12 pc

7				size	pitch
COUNTERSINK BITS:					
GFB161	GFB	Chrome vanadium steel - round shank	13mm	90°	
GFB162	GFB	Chrome vanadium steel - round shank	16mm	90°	
GFB163	GFB	Chrome vanadium steel - round shank	19mm	90°	
GFB164	GFB	Chrome Vanadium steel - set of 3	12 - 19mm	90°	
GN195-13	GENERAL	High Speed steel - round shank	13mm	82°	
GN195-19	GENERAL	High Speed steel - round shank	19mm	82°	
SCREWDRILL COUNTERSINK BITS:					
			gauge	drill size	
GFB510	GFB	Adjustable Countersink bit	No 8	1/8"	
GFB511	GFB	Adjustable Countersink bit	No 10	9/64"	
GFB512	GFB	Adjustable Countersink bit	No 12	5/32"	
GFB532	GFB	Replacements bits for GFB510 (3 pack) + hex key	No 8	1/8"	
GFB533	GFB	Replacements bits for GFB511 (3 pack) + hex key	No 10	9/64"	
GFB534	GFB	Replacements bits for GFB512 (3 pack) + hex key	No 12	5/32"	
SM100-08	STAR M	Drill countersink - tool steel	8mm	3.0mm	
SM100-09	STAR M	Drill countersink - tool steel	9mm	3.0mm	
SM100-10	STAR M	Drill countersink - tool steel	10mm	3.5mm	
SM100-12	STAR M	Drill countersink - tool steel	12mm	4.0mm	
SQC43005	SNAPPY	Countersink with drill	No 4	5/64"	
SQC43006	SNAPPY	Countersink with drill	No 6	3/32"	
SQC43007	SNAPPY	Countersink with drill	No 8	7/64"	
SQC43008	SNAPPY	Countersink with drill	No 10	1/8"	
SQC43009	SNAPPY	Countersink with drill	No 12	9/64"	
SQC40030	SNAPPY	Countersink and drill set of 5 Contains: countersinks for: #4, #6, #8, #10, #12 gauge screws			
SM14-06	STAR M	Tapered drill countersink	No 6	3.6mm	
SM14-08	STAR M	Tapered drill countersink	No 8	4.0mm	
SM14-10	STAR M	Tapered drill countersink	No 10	5.0mm	
SM14-12	STAR M	Tapered drill countersink	No 12	5.5mm	
SM14TCT-09	STAR M	TCT fibre cement board countersink drill		9mm	
SM14TCT-18	STAR M	TCT fibre cement board countersink drill		18mm	
GFB60	GFB	Screw pilot drill - 6mm hex shank	No 6		
GFB61	GFB	Screw pilot drill - 6mm hex shank	No 8		
GFB62	GFB	Screw pilot drill - 6mm hex shank	No 10		
GFB63	GFB	Screw pilot drill - 6mm hex shank	No 12		
GFB64	GFB	Screw pilot drill - set of 4	Nos 6,8,10,12		
GN34-4	GENERAL	Screw pilot drill - set of 4	Nos 6,8,10,12		
SNPNPD-018	SUTTON	P&N Quickbit Hinge Mate	8g - 10g	3.18mm (1/8")	
PLUG CUTTERS:					
			screw gauge	plug size	
SM20-08	STAR M	Plug cutter - heat treated steel		8mm	
SM20-09	STAR M	Plug cutter - heat treated steel		9mm	
SM20-10	STAR M	Plug cutter - heat treated steel		10mm	
SM20-12	STAR M	Plug cutter - heat treated steel		12mm	



SM100-08
Drill countersink



SM20-08
Plug cutter



SM14-08
Drill countersink



SQC43005
Drill countersink



GN195-16
Countersink



GN195-16
Countersink



SM14TCT-09
TCT Drill countersink



SQC43007
Drill countersink



GFB161
Countersink



GFB162
Countersink



SM14TCT-18
TCT Drill countersink



SQC43009
Drill countersink



GFB510
Adjustable
Countersink



GFB533
Replacement
Countersink bits



GFB60
Countersink
with pilot drill



GFB63
Countersink
with pilot drill



SNPNPD-018
Quickbit Hinge
Installation Bit



GFB164
Countersink set



GFB64
Countersink with
pilot drill set



SQC40030
Countersink with
pilot drill set



GN34-4
Countersink with
pilot drill set

8		cap			
BOLT CUTTERS:				length	high tensile
HHBC300	HIT	Bolt cutter - centre cut high tensile jaws		300mm	4.0mm
HHBC350	HIT	Bolt cutter - centre cut high tensile jaws		350mm	5.0mm
HHBC450	HIT	Bolt cutter - centre cut high tensile jaws		450mm	5.5mm
HHBC600	HIT	Bolt cutter - centre cut high tensile jaws		600mm	7.0mm
HHBC750	HIT	Bolt cutter - centre cut high tensile jaws		750mm	8.0mm
HHBC900	HIT	Bolt cutter - centre cut high tensile jaws		900mm	9.0mm
HHBC1050	HIT	Bolt cutter - centre cut high tensile jaws		1050mm	10.0mm
MNBC450	MANOR	Bolt cutter - centre cut high tensile jaws		450mm	5.5mm
MNBC600	MANOR	Bolt cutter - centre cut high tensile jaws		600mm	7.0mm
MNBC750	MANOR	Bolt cutter - centre cut high tensile jaws		750mm	8.0mm
POCKET CUTTERS:					
HPH200	HIT	Pocket cutter - for piano wire		200mm	2.5mm
HTPC200	HIT	Pocket cutter - gen. purpose and for piano wire		200mm	2.5mm
BOLT CUTTER HEAD SETS AND JAWS:					
HHBCJ300	HIT	High tensile bolt cutter jaw set		300mm	4.0mm
HHBCJ350	HIT	High tensile bolt cutter jaw set		350mm	5.0mm
HHBCJ450	HIT	High tensile bolt cutter jaw set		450mm	5.5mm
HHBCJ600	HIT	High tensile bolt cutter jaw set		600mm	7.0mm
HHBCJ750	HIT	High tensile bolt cutter jaw set		750mm	8.0mm
HHBCJ900	HIT	High tensile bolt cutter jaw set		900mm	9.0mm
HHBCJ1050	HIT	High tensile bolt cutter jaw set		1050mm	10.0mm
THREADED ROD/MESH CUTTERS:				capacity soft rod/mesh	
HTRCA800	HIT	Concrete wire mesh cutter		10mm	
HTRCW10	HIT	Threaded rod cutter		6mm, 8mm, and 10mm	
HTXTRCC10S	HIT	Replacement Stainless Steel Die for HTRCW10			
HTXTRCW-10	HIT	Replacement Standard Die for HTRCW10			
ROD CUTTER BENDERS:				capacity soft rod	
HRC16B	HIT	Rod cutter bender - standard former For cutting and bending Re-Bar to 90° or 180°.		16mm Radius wheel: 32mm	
HRC16B-6D	HIT	Rod cutter bender - large former For cutting and bending Re-Bar to 90° or 180°.		16mm Radius wheel: 95mm	



HHBCJ300
Bolt cutter jaw set



HHBCJ350
Bolt cutter jaw set



HHBCJ450
Bolt cutter jaw set



HHBCJ600
Bolt cutter jaw set



HHBCJ750
Bolt cutter jaw set



HHBCJ900
Bolt cutter jaw set



HHBCJ1050
Bolt cutter jaw set



HPH200
Pocket cutter



HTPC200
Pocket cutter



HHBC300
300mm Bolt cutter



HHBC350
350mm Bolt cutter



HHBC450
450mm Bolt cutter



HHBC600
600mm Bolt cutter



HHBC750
750mm Bolt cutter



HHBC900
900mm Bolt cutter



HHBC1050
1050mm Bolt cutter



HTRCA800
Wire mesh cutter



MNBC750
750mm Bolt cutter



MNBC600
600mm Bolt cutter



MNBC450
450mm Bolt cutter



HRC16B
(Small former)



HRC16B-6D
(large former)



HTRCW10
Threaded rod cutter

ENGINEERS COLD CHISELS - CARDED:
length
width

MA10102	MAYHEW	"Select" Alloy steel - octagonal section - carded	113mm	1/4"
MA10202	MAYHEW	"Select" Alloy steel - octagonal section - carded	125mm	5/16"
MA10302	MAYHEW	"Select" Alloy steel - octagonal section - carded	125mm	3/8"
MA10402	MAYHEW	"Select" Alloy steel - octagonal section - carded	150mm	1/2"
MA10502	MAYHEW	"Select" Alloy steel - octagonal section - carded	150mm	5/8"
MA10602	MAYHEW	"Select" Alloy steel - octagonal section - carded	175mm	3/4"
MA10702	MAYHEW	"Select" Alloy steel - octagonal section - carded	189mm	7/8"
MA10802	MAYHEW	"Select" Alloy steel - octagonal section - carded	200mm	1"
MA12002	MAYHEW	"Select" Alloy steel - octagonal section - carded	300mm	1/2"
MA12102	MAYHEW	"Select" Alloy steel - octagonal section - carded	300mm	5/8"
MA12202	MAYHEW	"Select" Alloy steel - octagonal section - carded	300mm	3/4"
MA12402	MAYHEW	"Select" Alloy steel - octagonal section - carded	300mm	1"
MA89062	MAYHEW	"Select" Set of 3 alloy steel - octagonal section - pouch		3/8" 1/2" 5/8"
MA90002	MAYHEW	"Select" Set of 5 alloy steel - octagonal section -pouch		1/4" - 3/4"
MA60560	MAYHEW	"Pro" Set of 6 alloy steel - octagonal section - pouch		1/4" - 3/4"

ENGINEERS COLD CHISELS - GUARDED:
Length
Blade width

MA10805	MAYHEW	Guarded cold chisel	200mm	25mm
MA12405	MAYHEW	Guarded cold chisel	300mm	25mm
ST16-332	STANLEY	Fatmax Guarded cold chisel	300mm	25mm

ENGINEERS CAPE CHISELS - BULK:

MA10402-M	MAYHEW	"Pro" Cape chisel	131mm	1/4"
-----------	--------	-------------------	-------	------

GAURDED MASONRY CHISELS:
length
blade width

FP1235	FOOTPRINT	Masonry chisel - hand grip and guard	200mm	64mm
FP1237-075	FOOTPRINT	Bolster chisel - hand grip and guard	225mm	75mm
FP1237-100	FOOTPRINT	Bolster chisel - hand grip and guard	225mm	100mm
FP1237-113	FOOTPRINT	Bolster chisel - hand grip and guard	225mm	113mm
ST16-328	STANLEY	Fatmax brick Bolster Chisel - hand grip and guard	215mm	100mm



MA89062
Cold chisel set



MA90002
Cold chisel set



MA60560
Cold chisel set



MA10302
Cold chisel



MA10402
Cold chisel



MA10802
Cold chisel



MA12002
Cold chisel



ST16-332
Guarded cold chisel



MA12405
Guarded cold chisel



FP1237-075
Bolster chisel



FP1237-100
Bolster chisel



FP1237-113
Bolster chisel



ST16-328
Bolster chisel

WOOD CHISELS:
blade width

DRWC06	DRAPER	Pound Thru wood chisel	6mm
DRWC10	DRAPER	Pound Thru wood chisel	10mm
DRWC13	DRAPER	Pound Thru wood chisel	13mm
DRWC16	DRAPER	Pound Thru wood chisel	16mm
DRWC19	DRAPER	Pound Thru wood chisel	19mm
DRWC22	DRAPER	Pound Thru wood chisel	22mm
DRWC25	DRAPER	Pound Thru wood chisel	25mm
DRWC32	DRAPER	Pound Thru wood chisel	32mm
DRWC38	DRAPER	Pound Thru wood chisel	38mm
ST16-975	STANLEY	Fatmax Butt Chisel - tang thru	12mm
ST16-977	STANLEY	Fatmax Butt Chisel - tang thru	18mm
ST16-978	STANLEY	Fatmax Butt Chisel - tang thru	25mm
ST16-979	STANLEY	Fatmax Butt Chisel - tang thru	32mm
ST16-980	STANLEY	Fatmax Butt Chisel - tang thru	38mm
ST16-981	STANLEY	Fatmax Butt Chisel - tang thru	50mm
ST16-251	STANLEY	Dynagrip Pro wood chisel - plastic handle steel cap	6mm
ST16-253	STANLEY	Dynagrip Pro wood chisel - plastic handle steel cap	10mm
ST16-254	STANLEY	Dynagrip Pro wood chisel - plastic handle steel cap	12mm
ST16-257	STANLEY	Dynagrip Pro wood chisel - plastic handle steel cap	16mm
ST16-258	STANLEY	Dynagrip Pro wood chisel - plastic handle steel cap	18mm
ST16-260	STANLEY	Dynagrip Pro wood chisel - plastic handle steel cap	22mm
ST16-261	STANLEY	Dynagrip Pro wood chisel - plastic handle steel cap	25mm
ST16-263	STANLEY	Dynagrip Pro wood chisel - plastic handle steel cap	32mm
ST16-265	STANLEY	Dynagrip Pro wood chisel - plastic handle steel cap	38mm
ST16-267	STANLEY	Dynagrip Pro wood chisel - plastic handle steel cap	50mm
STFMHTO-16067	STANLEY	FATMAX side strike chisel	25mm

WOOD CHISEL SETS:
Sizes

DRWCSET4	DRAPER	Set of 4 Pound thru wood chisel set	10, 12, 19, 25mm
FT301-2133	FULLER	Set of 3 Pro tang-thru wood chisels	13, 19, 25mm
ST16-268	STANLEY	Set of 3 Dynagrip Pro chisels	12, 18, 25mm
ST16-970	STANLEY	Set of 3 Pro tang-thru butt chisels	12, 18, 25mm
ST16-883	STANLEY	Set of 3 Dynagrip Pro chisels	12, 18, 25mm
ST16-269	STANLEY	Set of 5 Dynagrip Pro chisels	6, 12, 18, 25, 32mm
ST16-050	STANLEY	3 pc Sharpening system for chisels/planer blades	



DRWC06
Pound thru wood chisel



ST16-254
Dynagrip Pro wood chisel



DRWC16
Pound thru wood chisel



ST16-261
Dynagrip Pro wood chisel



DRWC25
Pound thru wood chisel



ST16-263
Dynagrip Pro wood chisel



DRWC32
Pound thru wood chisel



ST16-975
Butt chisel



STFMHTO-16067
Side strike chisel



ST16-975
Butt chisel



ST16-980
Butt chisel



ST16-050
Sharpening system kit



ST16-970
Tang-thru butt chisel set of 3



ST16-883
Dynagrip chisel set of 3



ST16-268
Dynagrip chisel set of 3



ST16-269
Dynagrip chisel set of 5



DRWCSET4
Pound thru wood chisel set of 4



FT301-2133
Wood chisel of 3

11				Capacity	Opening
QUICK BAR/SPREADER CLAMPS:					
AJP33804	JORGENSEN	E-Z HOLD Hobby Bar Clamp	23kg (50lb)	100mm (4")	
AJP33808	JORGENSEN	E-Z HOLD Hobby Bar Clamp	23kg (50lb)	200mm (8")	
AJP33606	JORGENSEN	E-Z HOLD Light-Duty Bar Clamp	68kg (150lb)	150mm (6")	
AJP33612	JORGENSEN	E-Z HOLD Light-Duty Bar Clamp	68kg (150lb)	305mm (12")	
AJP33406	JORGENSEN	E-Z HOLD Medium-Duty Bar Clamp	136kg (300lb)	170mm (6")	
AJP33412	JORGENSEN	E-Z HOLD Medium-Duty Bar Clamp	136kg (300lb)	320mm (12")	
AJP33418	JORGENSEN	E-Z HOLD Medium-Duty Bar Clamp	136kg (300lb)	475mm (18")	
AJP33424	JORGENSEN	E-Z HOLD Medium-Duty Bar Clamp	136kg (300lb)	625mm (24")	
AJP33436	JORGENSEN	E-Z HOLD Medium-Duty Bar Clamp	136kg (300lb)	930mm (36")	
AJP33712	JORGENSEN	E-Z HOLD Heavy-Duty Bar Clamp	272kg (600lb)	300mm (12")	
AJP33724	JORGENSEN	E-Z HOLD Heavy-Duty Bar Clamp	272kg (600lb)	600mm (24")	
AJP33736	JORGENSEN	E-Z HOLD Heavy-Duty Bar Clamp	272kg (600lb)	900mm (36")	
AJP7463	JORGENSEN	Replacement Clamp Pad Set for AJP337 Series			
AJP7462	JORGENSEN	Replacement Clamp Pad Set for AJP334 Series			
SPRING / HAND CLAMPS:				Capacity	Opening
AJP3201HT	PONY	Spring Clamp - protective handles and jaw tips	---	25mm (1")	
AJP3202HT	PONY	Spring Clamp - protective handles and jaw tips	---	50mm (2")	
AJP3203HT	PONY	Spring Clamp - protective handles and jaw tips	---	75mm (3")	
AJP32225	PONY	Hand Clamp	---	50mm (2")	
AJP32400	PONY	Hand Clamp	---	100mm (4")	
AJP3251	PONY	Adjustable Spring Clamp	1lb-50lb	25mm (1")	
AJP3252	PONY	Adjustable Spring Clamp	1lb-50lb	50mm (2")	
C-CLAMPS:				Capacity	Opening
AJP2620C	PONY	Hobby C-Clamp	181kg (400lb)	50mm (2")	
AJP2630C	PONY	Hobby C-Clamp	362kg (800lb)	75mm (3")	
AJP1440C	PONY	Light-Duty C-Clamp	544kg (1200lb)	100mm (4")	
AJP1460C	PONY	Light-Duty C-Clamp	544kg (1200lb)	150mm (6")	
AJP1480C	PONY	Light-Duty C-Clamp	544kg (1200lb)	200mm (8")	
F-CLAMPS:				Capacity	Opening
AJP4512	JORGENSEN	5 Inch Deep Reach Steel Bar Clamp	544kg (1200lb)	304mm (12")	
AJP4524	JORGENSEN	6 Inch Deep Reach Steel Bar Clamp	544kg (1200lb)	609mm (24")	
AJP4536	JORGENSEN	7 Inch Deep Reach Steel Bar Clamp	544kg (1200lb)	914mm (36")	
PIPE CLAMPS:					Suits Pipe
AJP50	PONY	Pipe Clamp Fixture (<i>pipe not included</i>)		19mm (3/4")	
SASH / T-BAR CLAMPS:					Length
TWTBAR1200	STANWAY	T-Bar Sash Clamp		1200mm	
TWTBAR1800	STANWAY	T-Bar Sash Clamp		1800mm	
SUNDRY CLAMPING AND LIFTING TOOLS:					
DRMWC	DRAPER	Magnetic Welders Clamp (45° / 75° / 135°)	102 x 158 x 12mm (HxWxD)		
AJP1215	PONY	Band Clamp with Plastic Corner Jaws		5m x 25mm	
DRIAW160	DRAPER	Inflatable Air Wedge (150kg Capacity)		160mm x 160mm	
STFMHT83550	STANLEY	FATMAX®TradeLift		150kg/220mm Capacity	
STFMHT83552	STANLEY	FATMAX®TradeLift (2 Pack)		150kg/220mm Capacity	
WORKTABLES AND SAWHORSES:					
AJP60	PONY	2-in-1 Clamping Worktable & Sawhorse			
AJP60400	PONY	2pc Clamping Sawhorses			



AJP3252
50mm Adjust-A-Clamp



AJP3202HT
50mm Spring clamp



AJP32225
57mm Hand clamp



AJP1460C
H/D C-clamp 200mm



DRMWC
Mag. welders clamp



AJP1215
Band clamp



AJP50
Pipe clamp
(pipe not included)



AJP337 series
Heavy-Duty E-Z HOLD
Expandable Bar Clamp



AJP334 series
Medium-Duty E-Z HOLD
Expandable Bar Clamp



AJP336 series
Light-Duty E-Z HOLD
Expandable Bar Clamp



AJP338 series
E-Z HOLD Hobby Bar Clamp



AJP4512
Steel Bar Clamp



AJP7463
Clamp Pads for
Heavy-Duty



AJP7462
Clamp Pads for
Medium-Duty



AJP60
2-in-1 Worktable



AJP60400
2pc Sawhorse Set



STFMHT83550
FATMAX® TradeLift™



DRIAW160
Inflatable air wedge

12					
CIRCLE CUTTERS:				capacity	
HS-03L	MULTI	Recessed ceiling light hole cutter - adjustable		30mm - 203mm	
GN4	GENERAL	Circle cutter - combination shank		22mm - 100mm	
GN5B	GENERAL	Circle cutter - 10mm round shank		25mm - 150mm	
GN55	GENERAL	Circle cutter - 1/2" shank		44mm - 190mm	
GNX4-BLADE	GENERAL	Blade only for GN4 and GN5B Circle cutters			
GNX4-DRILL	GENERAL	Pilot drill only for GN4 circle cutter			
CABLE CUTTERS:				length	
HTSC30	HIT	Cable cutter - cuts to 11mm alum cable		240mm	
HTHWC6	HIT	Wire rope cutter - for soft and hard steel wire		190mm	
CH911G	CHANNELLOCK	PVC Coated handles - cuts to 11mm alum cable		240mm	
HT-CC30	HIT	steel tube handles - cuts to 30mm alum cable		750mm	
HT-CC50	HIT	steel tube handles - cuts to 50mm alum cable		1050mm	
FIBRO CUTTERS:					
BL4	STANWAY	Fibro cement cutter			
TW-HAR	STANWAY	Cement board score and snap knife			
STRAP CUTTERS:				length	
HT-SS450	HIT	Steel strap cutter		450mm	
HT-SS650	HIT	Steel strap cutter		650mm	
GLASS CUTTERS:					
PG569-00	PG	Glass cutter - 6 wheel			
DT200	DIAMANTOR	Glass cutter - single wheel			
KST305	K STAR	Glass cutter - oil fill			
TILE DRILLS:				length	diameter
PG728-00	PG	Glass and tile drill bit - tungsten carbide tipped		55mm	3.0mm
PG728-10	PG	Glass and tile drill bit - tungsten carbide tipped		65mm	4.0mm
PG728-20	PG	Glass and tile drill bit - tungsten carbide tipped		65mm	5.0mm
PG728-30	PG	Glass and tile drill bit - tungsten carbide tipped		65mm	6.0mm
PG728-40	PG	Glass and tile drill bit - tungsten carbide tipped		65mm	8.0mm
PG728-50	PG	Glass and tile drill bit - tungsten carbide tipped		75mm	10.0mm
PG728-60	PG	Glass and tile drill bit - tungsten carbide tipped		75mm	12.0mm
GFB554	GFB	Glass and Tile Drill Bit - 4 Blade		70mm	5.0mm
GFB555	GFB	Glass and Tile Drill Bit - 4 Blade		75mm	6.0mm
GFB556	GFB	Glass and Tile Drill Bit - 4 Blade		75mm	6.5mm
GFB557	GFB	Glass and Tile Drill Bit - 4 Blade		80mm	8.0mm
GFB558	GFB	Glass and Tile Drill Bit - 4 Blade		100mm	10.0mm
MR105-05	MORSE	Diamond grit holesaw		100mm	5mm
MR105-06	MORSE	Diamond grit holesaw		100mm	6mm
MR105-08	MORSE	Diamond grit holesaw		100mm	8mm
MR105-10	MORSE	Diamond grit holesaw		100mm	10mm
MR105-13	MORSE	Diamond grit holesaw		100mm	12.7mm
SR105-05	STARRETT	Diamond tile drill		60mm	5mm
SR105-06	STARRETT	Diamond tile drill		60mm	6mm
SR105-065	STARRETT	Diamond tile drill		60mm	6.5mm
SR105-08	STARRETT	Diamond tile drill		60mm	8mm
SR105-10	STARRETT	Diamond tile drill		60mm	10mm
SR105-12	STARRETT	Diamond tile drill		60mm	12mm
SRKD-TDG01	STARRETT	Diamond tile drill guide			



GN4
Circle cutter

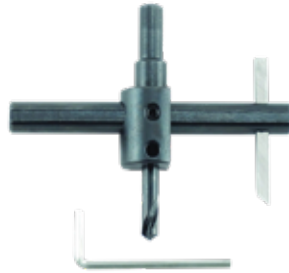

GN5B
Circle cutter



HS-03L
Ceiling light hole cutter



KST305
Oil fill glass cutter



PG569-00
6-wheel glass cutter



DT200
Glass cutter



PG728-10
Glass and tile drill



PG728-40
Glass and tile drill



GFB554
Glass and tile drill



GFB557
Glass and tile drill



TW-HAR
Score and snap knife



MR105-05
Diamond grit holesaw



MR105-08
Diamond grit holesaw



SR105-05
Diamond tile drill



SR105-10
Diamond tile drill



HT-CC30
Cable cutter



HTSC30
Cable cutter



CH911G
Cable cutter



HT-SS450
Strap cutter



SRKD-TDG01
Diamond tile drill guide



HT-SS600
Strap cutter

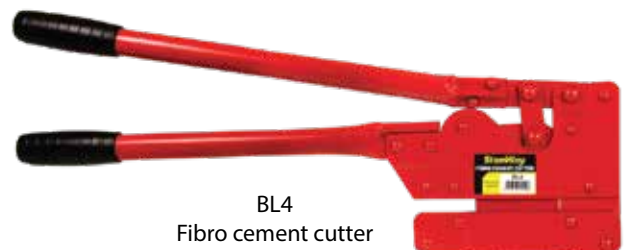

BL4
Fibro cement cutter

MASONRY CUT-OFF WHEELS:
diameter
bore size

CO115C22	ROBTEC	Masonry cut-off wheel - green label	115mm	22.2mm
----------	--------	-------------------------------------	-------	--------

METAL CUT-OFF WHEELS:
diameter
bore size

CO100A16	ROBTEC	Metal cut-off wheel - blue label	100mm	16.0mm
CO100A16-1MM	ROBTEC	Metal cut-off wheel - blue label - 1mm width	100mm	16.0mm
CO115A22	ROBTEC	Metal cut-off wheel - blue label	115mm	22.2mm
CO115A22-1MM	ROBTEC	Metal cut-off wheel - blue label - 1mm width	115mm	22.2mm
CO125A22	ROBTEC	Metal cut-off wheel - blue label	125mm	22.2mm
CO125A22-1MM	ROBTEC	Metal cut-off wheel - blue label - 1mm width	125mm	22.2mm

ABRASIVE STONES/SANDING DISCS:
size

DRCSS-200	DRAPER	Silicone Carbide sharpening stone with box	200mm x 50mm x 25mm
DRSSB	DRAPER	Sharpening stone box and lid for stones	200mm x 50mm x 25mm
NRBF28	NORTON	Fluted rubbing brick	200mm x 50mm x 50mm
MT840	MARSHALLTOWN	Fluted rubbing brick - handled	150mm x 75mm x 25mm
MT841	MARSHALLTOWN	Fluted rubbing brick - handled	200mm x 88mm x 38mm

MASONRY CUT OFF DISCS



CO115C22
115 x 22.2 x 3.2mm

1MM METAL CUT OFF DISCS



CO100A16-1MM
100 x 16 x 1.2mm



CO115A22-1MM
115 x 22.2 x 1.2mm



CO125A22-1MM
125 x 22.2 x 1.2mm

METAL CUT OFF DISCS



CO100A16
100 x 16 x 3.2mm



CO115A22
115 x 22.2 x 3.2mm



CO125A22
125 x 22.2 x 3.2mm

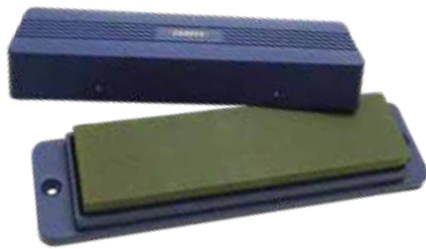

DRCSS-200
Sharpening stone & box
200 x 50 x 25mm



DRSSB
Oil stone box
(Empty)



MT841
Rubbing brick
200 x 88 x 38mm



MT840
Rubbing brick
150 x 75 x 25mm



NRBF28
Rubbing brick
200 x 50 x 50mm

RIVET TOOLS:
Rivet sizes Capacity

HR001	HIT	Medium duty Rivet tool	Alum: 2.4, 3.2, 4.0, 4.8mm
-------	-----	------------------------	-----------------------------------

RIVET TOOL KITS:

DRHRK2448	DRAPER	Hand Riveter Kit for Aluminium Rivets	Aluminium: 2.4, 3.2, 4.0, 4.8mm
-----------	--------	---------------------------------------	--

LAZY TONG RIVET TOOLS:
Rivet sizes Capacity

HR005	HIT	Lazy tong 3-jaw Rivet tool - Built in shock absorbers	Aluminium: 3.2, 4.0, 4.8mm
-------	-----	---	-----------------------------------

LONG ARM RIVET TOOLS:

HR003	HIT	Long arm 3-jaw Rivet tool	Aluminium: 3.2, 4.0, 4.8mm
-------	-----	---------------------------	-----------------------------------

WIRE TIE DRILLERS:

DRWTD	DRAPER	Bag tie twister	260mm
-------	--------	-----------------	-------

CHIP BRUSHES:

HDNTCB25	HAYDN	Chip brush	25mm
----------	-------	------------	------

HDNTCB50	HAYDN	Chip brush	50mm
----------	-------	------------	------

HDNTCB75	HAYDN	Chip brush	75mm
----------	-------	------------	------

HDNTCB100	HAYDN	Chip brush	100mm
-----------	-------	------------	-------

HAND RIVET TOOLS



HR001
Medium Duty



DRHRK2448
Hand Rivet Tool Kit

LAZY TONG RIVET TOOLS



HR005

LONG ARM RIVET TOOLS

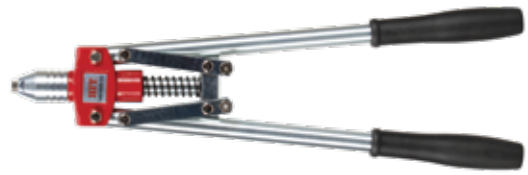

HR003



DRWTD
Pro. wire tie driller



HDNTCB25
Chip Brush



HDNTCB50
Chip Brush



HDNTCB75
Chip Brush



HDNTCB100
Chip Brush

STANDARD HSS METRIC TWIST DRILL BITS - CARDED
Size
Length
Quantity

PG10-0100	PG PROFESSIONAL	HSS Drill Bit	1mm	34mm	2 Pack
PG10-0150	PG PROFESSIONAL	HSS Drill Bit	1.5mm	40mm	2 Pack
PG10-0750	PG PROFESSIONAL	HSS Drill Bit	7.5mm	109mm	1 Pack
PG10-0850	PG PROFESSIONAL	HSS Drill Bit	8.5mm	117mm	1 Pack
PG10-0950	PG PROFESSIONAL	HSS Drill Bit	9.5mm	125mm	1 Pack
PG10-1050	PG PROFESSIONAL	HSS Drill Bit	10.5mm	133mm	1 Pack
PG10-1150	PG PROFESSIONAL	HSS Drill Bit	11.5mm	142mm	1 Pack
PG10-1250	PG PROFESSIONAL	HSS Drill Bit	12.5mm	151mm	1 Pack
DR102-0100	DRAPER	HSS Titanium Drill Bit	1mm	34mm	1 Pack
DR202-0100	DRAPER	HSS Titanium Drill Bit	1mm	34mm	2 Pack
DR102-0150	DRAPER	HSS Titanium Drill Bit	1.5mm	40mm	1 Pack
DR202-0150	DRAPER	HSS Titanium Drill Bit	1.5mm	40mm	2 Pack
DR102-0200	DRAPER	HSS Titanium Drill Bit	2mm	49mm	1 Pack
DR202-0200	DRAPER	HSS Titanium Drill Bit	2mm	49mm	2 Pack
DR202-0250	DRAPER	HSS Titanium Drill Bit	2.5mm	57mm	2 Pack
DR202-0300	DRAPER	HSS Titanium Drill Bit	3mm	61mm	2 Pack
DR202-0350	DRAPER	HSS Titanium Drill Bit	3.5mm	70mm	2 Pack
DR202-0400	DRAPER	HSS Titanium Drill Bit	4mm	75mm	2 Pack
DR202-0450	DRAPER	HSS Titanium Drill Bit	4.5mm	80mm	2 Pack
DR102-0500	DRAPER	HSS Titanium Drill Bit	5mm	86mm	1 Pack
DR202-0500	DRAPER	HSS Titanium Drill Bit	5mm	86mm	2 Pack
DR202-0550	DRAPER	HSS Titanium Drill Bit	5.5mm	93mm	2 Pack
DR102-0600	DRAPER	HSS Titanium Drill Bit	6mm	93mm	1 Pack
DR202-0600	DRAPER	HSS Titanium Drill Bit	6mm	93mm	2 Pack
DR102-0650	DRAPER	HSS Titanium Drill Bit	6.5mm	101mm	1 Pack
DR102-0700	DRAPER	HSS Titanium Drill Bit	7mm	109mm	1 Pack
DR102-0750	DRAPER	HSS Titanium Drill Bit	7.5mm	109mm	1 Pack
DR102-0800	DRAPER	HSS Titanium Drill Bit	8mm	117mm	1 Pack
DR102-0850	DRAPER	HSS Titanium Drill Bit	8.5mm	117mm	1 Pack
DR102-0900	DRAPER	HSS Titanium Drill Bit	9mm	125mm	1 Pack
DR102-0950	DRAPER	HSS Titanium Drill Bit	9.5mm	125mm	1 Pack
DR102-1000	DRAPER	HSS Titanium Drill Bit	10mm	133mm	1 Pack
DR102-1050	DRAPER	HSS Titanium Drill Bit	10.5mm	133mm	1 Pack
DR102-1100	DRAPER	HSS Titanium Drill Bit	11mm	142mm	1 Pack
DR102-1150	DRAPER	HSS Titanium Drill Bit	11.5mm	142mm	1 Pack
DR102-1200	DRAPER	HSS Titanium Drill Bit	12mm	151mm	1 Pack
DR102-1250	DRAPER	HSS Titanium Drill Bit	12.5mm	151mm	1 Pack
DR102-1300	DRAPER	HSS Titanium Drill Bit	13mm	151mm	1 Pack
SNVP102-0100	SUTTON	VIPER HSS Drill Bit	1mm	34mm	1 Pack
SNVP102-0150	SUTTON	VIPER HSS Drill Bit	1.5mm	40mm	1 Pack
SNVP102-0200	SUTTON	VIPER HSS Drill Bit	2mm	49mm	1 Pack
SNVP102-0250	SUTTON	VIPER HSS Drill Bit	2.5mm	57mm	1 Pack
SNVP102-0300	SUTTON	VIPER HSS Drill Bit	3mm	61mm	1 Pack
SNVP102-0350	SUTTON	VIPER HSS Drill Bit	3.5mm	70mm	1 Pack
SNVP102-0400	SUTTON	VIPER HSS Drill Bit	4mm	75mm	1 Pack
SNVP102-0450	SUTTON	VIPER HSS Drill Bit	4.5mm	80mm	1 Pack
SNVP102-0500	SUTTON	VIPER HSS Drill Bit	5mm	86mm	1 Pack
SNVP102-0550	SUTTON	VIPER HSS Drill Bit	5.5mm	93mm	1 Pack
SNVP102-0600	SUTTON	VIPER HSS Drill Bit	6mm	93mm	1 Pack
SNVP102-0650	SUTTON	VIPER HSS Drill Bit	6.5mm	101mm	1 Pack
SNVP102-0700	SUTTON	VIPER HSS Drill Bit	7mm	109mm	1 Pack
SNVP102-0750	SUTTON	VIPER HSS Drill Bit	7.5mm	109mm	1 Pack
SNVP102-0800	SUTTON	VIPER HSS Drill Bit	8mm	117mm	1 Pack
SNVP102-0850	SUTTON	VIPER HSS Drill Bit	8.5mm	117mm	1 Pack
SNVP102-0900	SUTTON	VIPER HSS Drill Bit	9mm	125mm	1 Pack
SNVP102-0950	SUTTON	VIPER HSS Drill Bit	9.5mm	125mm	1 Pack
SNVP102-1000	SUTTON	VIPER HSS Drill Bit	10mm	133mm	1 Pack
SNVP102-1050	SUTTON	VIPER HSS Drill Bit	10.5mm	133mm	1 Pack
SNVP102-1100	SUTTON	VIPER HSS Drill Bit	11mm	142mm	1 Pack
SNVP102-1150	SUTTON	VIPER HSS Drill Bit	11.5mm	142mm	1 Pack
SNVP102-1200	SUTTON	VIPER HSS Drill Bit	12mm	151mm	1 Pack
SNVP102-1250	SUTTON	VIPER HSS Drill Bit	12.5mm	151mm	1 Pack
SNVP102-1300	SUTTON	VIPER HSS Drill Bit	13mm	151mm	1 Pack
SN333-0300	SUTTON	HSS Drill Bits	3mm	61mm	10 Pack
SN333-0400	SUTTON	HSS Drill Bits	4mm	75mm	10 Pack
SN333-0500	SUTTON	HSS Drill Bits	5mm	86mm	5 Pack



PG10-0150
1.5mm x 40mm
2 pack



PG10-1150
11.5mm x 137mm



DR102-0200
2mm x 49mm



DR202-0400
4mm x 75mm
2 pack



DR102-1100
11mm x 137mm



SNVP102-0350
3.5mm x 67mm



SNVP102-1100
11mm x 137mm



SN333-0300
3mm x 62mm
10 pack



SN333-0500
5mm x 85mm
5 pack

LONG SERIES HSS METRIC TWIST DRILL BITS - CARDED				Size	Length	Quantity	
DR202X-0300	DRAPER	HSS Long Series Drill Bit		3mm	100mm	2 Pack	
DR102X-0350	DRAPER	HSS Long Series Drill Bit		3.5mm	112mm	1 Pack	
DR202X-0350	DRAPER	HSS Long Series Drill Bit		3.5mm	112mm	2 Pack	
DR202X-0400	DRAPER	HSS Long Series Drill Bit		4mm	119mm	2 Pack	
DR102X-0500	DRAPER	HSS Long Series Drill Bit		5mm	132mm	1 Pack	
DR102X-0600	DRAPER	HSS Long Series Drill Bit		6mm	139mm	1 Pack	
DR102X-0800	DRAPER	HSS Long Series Drill Bit		8mm	165mm	1 Pack	
DR102X-1000	DRAPER	HSS Long Series Drill Bit		10mm	184mm	1 Pack	
SN102X-0300	SUTTON	HSS Long Series Drill Bit		3mm	130mm	1 Pack	
SN102X-0350	SUTTON	HSS Long Series Drill Bit		3.5mm	137mm	1 Pack	
SN102X-0400	SUTTON	HSS Long Series Drill Bit		4mm	146mm	1 Pack	
SN102X-0500	SUTTON	HSS Long Series Drill Bit		5mm	152mm	1 Pack	
SN102X-0550	SUTTON	HSS Long Series Drill Bit		5.5mm	152mm	1 Pack	
SN102X-0600	SUTTON	HSS Long Series Drill Bit		6mm	156mm	1 Pack	
SN102X-0650	SUTTON	HSS Long Series Drill Bit		6.5mm	159mm	1 Pack	
SN102X-0700	SUTTON	HSS Long Series Drill Bit		7mm	162mm	1 Pack	
SN102X-0800	SUTTON	HSS Long Series Drill Bit		8mm	164mm	1 Pack	
SN102X-0900	SUTTON	HSS Long Series Drill Bit		9mm	171mm	1 Pack	
SN102X-1000	SUTTON	HSS Long Series Drill Bit		10mm	178mm	1 Pack	
SN102X-1100	SUTTON	HSS Long Series Drill Bit		11mm	184mm	1 Pack	
SN102X-1200	SUTTON	HSS Long Series Drill Bit		12mm	197mm	1 Pack	
SN102X-1300	SUTTON	HSS Long Series Drill Bit		13mm	203mm	1 Pack	
REDUCED SHANK				Size	Length	Flute	Quantity
SN12-1400	SUTTON	1/2" Reduced Shank HSS Drill Bit		14mm	152mm	86mm	1 Pack
SN12-1600	SUTTON	1/2" Reduced Shank HSS Drill Bit		16mm	152mm	86mm	1 Pack
SN12-1800	SUTTON	1/2" Reduced Shank HSS Drill Bit		18mm	152mm	86mm	1 Pack
SN12-1900	SUTTON	1/2" Reduced Shank HSS Drill Bit		19mm	152mm	86mm	1 Pack
SN12-2000	SUTTON	1/2" Reduced Shank HSS Drill Bit		20mm	152mm	86mm	1 Pack
OTHER DRILL BITS				Size	Length	Quantity	
SN0800SW	SUTTON	Spot Weld Drill Bit		8mm	45mm	1 Pack	
STEP DRILL BITS				Increments	Size		
FAISD620	FAITHFULL	HSS Step Drill Bit		2mm	6mm - 20mm		
DRSDB0430	DRAPER	HSS Step Drill Bit		2mm	4mm - 30mm		

LONG SERIES - CARDED



SN102X-0350
3.5mm x 139mm



SN102X-0800
8mm x 169mm



DR102X-0350
3.5mm x 100mm



DR102X-0800
8mm x 165mm

REDUCED SHANK - METRIC



SN12 Series
1/2" Reduced shank drill

OTHER DRILLS



SN0800SW
8mm x 45mm Spot Weld Drill

STEP DRILL BITS



DRSDB0430
4mm - 30mm



FAISD620
6mm - 20mm

17						
MASONRY DRILLS - STANDARD FIXING				Size	Length	Flute
SN0300SF	SUTTON	TCT Masonry Drill Bit	3mm	60mm	20mm	
SN0400SF	SUTTON	TCT Masonry Drill Bit	4mm	75mm	35mm	
SN0500SF	SUTTON	TCT Masonry Drill Bit	5mm	85mm	45mm	
SN0550SF	SUTTON	TCT Masonry Drill Bit	5.5mm	95mm	45mm	
SN0600SF	SUTTON	TCT Masonry Drill Bit	6mm	100mm	60mm	
SN0650SF	SUTTON	TCT Masonry Drill Bit	6.5mm	100mm	60mm	
SN0700SF	SUTTON	TCT Masonry Drill Bit	7mm	100mm	60mm	
SN0800SF	SUTTON	TCT Masonry Drill Bit	8mm	120mm	80mm	
SN1000SF	SUTTON	TCT Masonry Drill Bit	10mm	120mm	80mm	
SN1200SF	SUTTON	TCT Masonry Drill Bit	12mm	120mm	80mm	
SN1300SF	SUTTON	TCT Masonry Drill Bit	13mm	120mm	80mm	
PG0300SF	PG PROFESSIONAL	TCT Masonry Drill Bit	3mm	64mm	34mm	
PG0400SF	PG PROFESSIONAL	TCT Masonry Drill Bit	4mm	75mm	43mm	
PG0500SF	PG PROFESSIONAL	TCT Masonry Drill Bit	5mm	85mm	49mm	
PG0600SF	PG PROFESSIONAL	TCT Masonry Drill Bit	6mm	100mm	58mm	
DR0400SF	DRAPER	TCT Masonry Drill Bit	4mm	75mm	45mm	
DR0500SF	DRAPER	TCT Masonry Drill Bit	5mm	85mm	50mm	
DR0600SF	DRAPER	TCT Masonry Drill Bit	6mm	100mm	60mm	
DR0700SF	DRAPER	TCT Masonry Drill Bit	7mm	100mm	60mm	
DR0800SF	DRAPER	TCT Masonry Drill Bit	8mm	120mm	85mm	
DR1000SF	DRAPER	TCT Masonry Drill Bit	10mm	120mm	85mm	
BZ0400SF	BENZ	Masonry Drill Bit	4mm	75mm	40mm	
BZ0800SF	BENZ	Masonry Drill Bit	8mm	120mm	70mm	
MASONRY DRILLS - SINGLE BRICK				Size	Length	Flute
SN0500SB	SUTTON	TCT Masonry Drill Bit	5mm	150mm	110mm	
SN0550SB	SUTTON	TCT Masonry Drill Bit	5.5mm	150mm	110mm	
SN0600SB	SUTTON	TCT Masonry Drill Bit	6mm	150mm	110mm	
SN0650SB	SUTTON	TCT Masonry Drill Bit	6.5mm	150mm	110mm	
SN0800SB	SUTTON	TCT Masonry Drill Bit	8mm	150mm	110mm	
SN1000SB	SUTTON	TCT Masonry Drill Bit	10mm	150mm	110mm	
SN1100SB	SUTTON	TCT Masonry Drill Bit	11mm	150mm	110mm	
SN1200SB	SUTTON	TCT Masonry Drill Bit	12mm	150mm	110mm	
SN1300SB	SUTTON	TCT Masonry Drill Bit	13mm	150mm	110mm	
SN1400SB	SUTTON	TCT Masonry Drill Bit	14mm	150mm	110mm	
SN1600SB	SUTTON	TCT Masonry Drill Bit	16mm	150mm	110mm	
SN2000SB	SUTTON	TCT Masonry Drill Bit	20mm	160mm	110mm	
SN2200SB	SUTTON	TCT Masonry Drill Bit	22mm	160mm	110mm	
SN2500SB	SUTTON	TCT Masonry Drill Bit	25mm	160mm	110mm	
DR0500SB	DRAPER	TCT Masonry Drill Bit	5mm	150mm	86mm	
DR0600SB	DRAPER	TCT Masonry Drill Bit	6mm	150mm	86mm	
DR0650SB	DRAPER	TCT Masonry Drill Bit	6.5mm	150mm	86mm	
DR0800SB	DRAPER	TCT Masonry Drill Bit	8mm	150mm	86mm	
DR1000SB	DRAPER	TCT Masonry Drill Bit	10mm	150mm	86mm	
DR1200SB	DRAPER	TCT Masonry Drill Bit	12mm	150mm	86mm	
DR1400SB	DRAPER	TCT Masonry Drill Bit	14mm	150mm	86mm	
DR1600SB	DRAPER	TCT Masonry Drill Bit	16mm	150mm	86mm	
BZ1300SB	BENZ	Masonry Drill Bit	13mm	150mm	90mm	
MASONRY DRILLS - DOUBLE BRICK				Size	Length	Flute
SN0650DB	SUTTON	TCT Masonry Drill Bit	6.5mm	400mm	270mm	
SN0800DB	SUTTON	TCT Masonry Drill Bit	8mm	400mm	270mm	
SN1000DB	SUTTON	TCT Masonry Drill Bit	10mm	400mm	270mm	
SN1300DB	SUTTON	TCT Masonry Drill Bit	13mm	400mm	270mm	
SN1600DB	SUTTON	TCT Masonry Drill Bit	16mm	400mm	270mm	
SN2000DB	SUTTON	TCT Masonry Drill Bit	20mm	400mm	265mm	
SN2200DB	SUTTON	TCT Masonry Drill Bit	22mm	400mm	250mm	
SN2500DB	SUTTON	TCT Masonry Drill Bit	25mm	400mm	250mm	
PG1000DB	PG PROFESSIONAL	TCT Masonry Drill Bit	10mm	400mm	240mm	

SF SERIES (STANDARD FIXING)



SN0600SF
6.0mm x 100mm



PG0600SF
6.0mm x 100mm



DR0400SF
4.0mm x 75mm



BZ0400SF
4mm x 75mm

SB SERIES (SINGLE BRICK)



SN1000SB
10.0mm x 150mm



DR1000SB
10.0mm x 150mm



BZ1300SB
13.0mm x 150mm



SN2000DB
20.0mm x 400mm



PG1000DB
10.0mm x 400mm

SDS PLUS MASONRY BITS:				Length	Size	Pack qty
DRSDS-050160	DRAPER	SDS Plus masonry drill bit - 2-Blade	160mm	5.0mm	1pk	
DRSDS-060160	DRAPER	SDS Plus masonry drill bit - 2-Blade	160mm	6.0mm	1pk	
DRSDS-065160	DRAPER	SDS Plus masonry drill bit - 2-Blade	160mm	6.5mm	1pk	
DRSDS-065210	DRAPER	SDS Plus masonry drill bit - Hang tag	210mm	6.5mm	1pk	
DRSDS-080160	DRAPER	SDS Plus masonry drill bit - Hang tag	160mm	8.0mm	1pk	
DRSDS-100160	DRAPER	SDS Plus masonry drill bit - 2-Blade	160mm	10.0mm	1pk	
DRSDS-100300	DRAPER	SDS Plus masonry drill bit - 2-Blade	300mm	10.0mm	1pk	
DRSDS-120150	DRAPER	SDS Plus masonry drill bit - Hang tag	150mm	12.0mm	1pk	
DRSDS-120210	DRAPER	SDS Plus masonry drill bit - Hang tag	210mm	12.0mm	1pk	
DRSDS-120260	DRAPER	SDS Plus masonry drill bit - Hang tag	260mm	12.0mm	1pk	
DRSDS-120300	DRAPER	SDS Plus masonry drill bit - Hang tag	300mm	12.0mm	1pk	
DRSDS-140160	DRAPER	SDS Plus masonry drill bit - Hang tag	160mm	14.0mm	1pk	
BZSDSP-140310	BENZ	SDS Plus masonry drill bit - Hang tag	310mm	14.0mm	1pk	
DRSDS-160160	DRAPER	SDS Plus masonry drill bit - Hang tag	160mm	16.0mm	1pk	
DRSDS-160260	DRAPER	SDS Plus masonry drill bit - Hang tag	260mm	16.0mm	1pk	
STUB DRILL BITS - METRIC & IMPERIAL				Size	Pack qty	
SN222-11	SUTTON	Panel stub drill bit #11 - Carded	4.85mm	2pk		
SN222-20	SUTTON	Panel stub drill bit #20 - Carded	4.09mm	2pk		
SN222-30	SUTTON	Panel stub drill bit #30 - Carded	3.26mm	2pk		
SNPN22-330	SUTTON	Double-ended HSS stub drill	3.30mm	10pk		
DR222-330	DRAPER	Double-ended HSS stub drill - Carded	3.30mm	2pk		
DR222-410	DRAPER	Double-ended HSS stub drill - Carded	4.10mm	2pk		
DR222-490	DRAPER	Double-ended HSS stub drill - Carded	4.90mm	2pk		
DR222-864	DRAPER	Double-ended HSS stub drill - Carded	1/8 inch	2pk		
DR333-330	DRAPER	Double-ended HSS stub drill - Carded	3.30mm	10pk		
DR333-410	DRAPER	Double-ended HSS stub drill - Carded	4.10mm	10pk		
DR333-490	DRAPER	Double-ended HSS stub drill - Carded	4.90mm	10pk		
DR333-864	DRAPER	Double-ended HSS stub drill - Carded	1/8 inch	10pk		
BZ222-330	BENZ	Double-ended panel drill	3.30mm	2pk		
BZ22-490	BENZ	Double-ended stub drill	4.90mm	1pk		



DRSDS-050160
5mm x 160mm



DRSDS-060160
6mm x 160mm



DRSDS-065160
6.5mm x 160mm



DRSDS-080160
8mm x 160mm



DRSDS-100160
10mm x 160mm



DRSDS-120150
12mm x 150mm



DRSDS-120300
12mm x 300mm



DRSDS-160160
16mm x 160mm



DRSDS-160260
16mm x 260mm



BZ22-490
4.90mm



DR222-410
4.09mm



DR333-410
4.09mm



SN222-11
4.85mm



SN222-30
3.26mm



SNPN22-330
3.30mm 10pk

HIGH SPEED TWIST DRILL SETS - METRIC:

size range

TWS1M	STANWAY	Set of 13 HS drills in metal case Sizes: 1.5, 2.0, 2.5, 3.0, 3.2, 3.5, 4.0, 4.5, 4.8, 5.0, 5.5, 6.0, 6.5mm	1.0mm - 6.5mm
TWS2M	STANWAY	Set of 19 HS drills in metal case Sizes: 1.0, 1.5, 2.0, 2.5, 3.0, 3.5, 4.0, 4.5, 5.0, 5.5, 6.0, 6.5, 7.0, 7.5, 8.0, 8.5, 9.0, 9.5, 10.0mm	1.0mm - 10.0mm
DRS2M	DRAPER	Set of 19 HSS Titanium Coated Drills in plastic case Sizes: 1.0, 1.5, 2.0, 2.5, 3.0, 3.5, 4.0, 4.5, 5.0, 5.5, 6.0, 6.5, 7.0, 7.5, 8.0, 8.5, 9.0, 9.5, 10.0mm	1.0mm - 10.0mm
TWS3M	STANWAY	Set of 25 HS drills in metal case Sizes: 1.0, 1.5, 2.0, 2.5, 3.0, 3.5, 4.0, 4.5, 5.0, 5.5, 6.0, 6.5, 7.0, 7.5, 8.0, 8.5, 9.0, 9.5, 10.0, 10.5, 11.0, 11.5, 12.0, 12.5, 13.0mm	1.0mm - 13.0mm
DRS3M	DRAPER	Set of 25 HSS Titanium Coated Drills in plastic case Sizes: 1.0, 1.5, 2.0, 2.5, 3.0, 3.5, 4.0, 4.5, 5.0, 5.5, 6.0, 6.5, 7.0, 7.5, 8.0, 8.5, 9.0, 9.5, 10.0, 10.5, 11.0, 11.5, 12.0, 12.5, 13.0mm	1.0mm - 13.0mm
SNS92258	FROST	Set of 19 HS drill in fold out plastic case Sizes: 1.0, 1.5, 2.0, 2.5, 3.0, 3.5, 4.0, 4.5, 5.0, 5.5, 6.0, 6.5, 7.0, 7.5, 8.0, 8.5, 9.0, 9.5, 10.0mm	1.0mm - 10.0mm



SNS92258
19pc HSS drills
1.0-10mm



TWS1M
13pc HSS drills
1.5 - 6.5mm



TWS2M
19pc HSS drills
1.0 - 10.0mm



TWS3M
25pc HSS drills
1.0 - 13.0mm



DRS2M
19pc HSS Titanium drills
1.0 - 10.0mm



DRS3M
25pc HSS Titanium drills
1.0 - 13.0mm

DRILL CHUCK KEYS:

GFBK101-10	GFB	Drill chuck key - Jacobs series MC2, MC6, KG, Rohm S14
GFBK102-36	GFB	Drill chuck key - Makita HP 1030
GFBK103-2	GFB	Drill chuck key - Jacobs series K2
GFBK104-11	GFB	Drill chuck key - Jacobs series MC4, KK
GFBK105	GFB	Drill chuck key - AEG, Bosch, Metabo
GFBK107-32	GFB	Drill chuck key - Jacobs series K32, K33
GFBK114	GFB	Drill chuck key - AEG, BoschG3M-16RE
GFBK116-34	GFB	Drill chuck key - Jacobs S2, Metabo 35 167, Rohm S2

KEYLESS DRILL CHUCKS AND ACCESSORIES:

chuck capacity

GFB87	GFB	Keyless chuck - 6mm capacity
KW834	KANZAWA	Right angle drill attachment - fitted with 10mm keyed chuck
KW836S	KANZAWA	Right angle drill attachment - fitted with #2 Phillips bit
GFB68	GFB	Drill powered pump
GN825	GENERAL	Drill grinding attachment



GFB87
Keyless drill chuck



GFBK107-32
Drill chuck key



GFBK101-10
Drill chuck key



KW834
Right angle drive



KW836S
Right angle drive



GN825
Drill grinding attachment



GFB68
Drill powered pump

STANDARD STAPLE GUN TACKERS:
Staple Length:
Brad Nail:

AP903	APEXON	Heavy Duty Staple Tacker - Aluminium	6mm (1/4") - 14mm (9/16")	16mm
AP850B	APEXON	Heavy Duty Staple Gun - Steel	6mm (1/4") - 14mm (9/16")	---
STTR110	STANLEY	Heavy Duty Staple Gun - Steel	6mm (1/4") - 14mm (9/16")	---
AP913	APEXON	Heavy Duty Hammer Tacker - Steel	6mm (1/4") - 12mm (1/2")	---

FLAT CROWN STAPLES:
Quantity:
Suits:

AP1006HD-2M	APEXON	6mm Staples - Carded	2000pc	AP903 / AP850B / STTR110 / AP913
AP1006HD-37M	APEXON	6mm Staples - Belt Clip Container	3750pc	AP903 / AP850B / STTR110 / AP913
AP1006HD-5M	APEXON	6mm Staples - Container	5000pc	AP903 / AP850B / STTR110 / AP913
AP1008HD-2M	APEXON	8mm Staples - Carded	2000pc	AP903 / AP850B / STTR110 / AP913
AP1008HD-28M	APEXON	8mm Staples - Belt Clip Container	2850pc	AP903 / AP850B / STTR110 / AP913
AP1008HD-5M	APEXON	8mm Staples - Container	5000pc	AP903 / AP850B / STTR110 / AP913
AP1010HD-2M	APEXON	10mm Staples - Carded	2000pc	AP903 / AP850B / STTR110 / AP913
AP1010HD-23M	APEXON	10mm Staples - Belt Clip Container	2350pc	AP903 / AP850B / STTR110 / AP913
AP1010HD-5M	APEXON	10mm Staples - Container	5000pc	AP903 / AP850B / STTR110 / AP913
AP1012HD-18M	APEXON	12mm Staples - Belt Clip Container	1850pc	AP903 / AP850B / STTR110 / AP913
AP1012HD-2M	APEXON	12mm Staples - Carded	2000pc	AP903 / AP850B / STTR110 / AP913
AP1012HD-4M	APEXON	12mm Staples - Container	4000pc	AP903 / AP850B / STTR110 / AP913
AP1014HD-2M	APEXON	14mm Staples - Carded	2000pc	AP903 / AP850B / STTR110
AP1014HD-3M	APEXON	14mm Staples - Container	3000pc	AP903 / AP850B / STTR110

CABLE / WIRE STAPLE GUN TACKERS:
Staple Length:
Max Cable Ø:

AP961	APEXON	Heavy Duty Cable Tacker - Aluminium	9mm (3/8") - 11mm (7/16")	5mm (3/16")
ART18	ARROW	Cable Staple Gun - Steel	10mm (3/8") - 11mm (7/16")	5mm (3/16")
AP962	APEXON	Heavy Duty Cable Tacker - Aluminium	10mm (3/8") - 14mm (9/16")	6mm (1/4")
ART25M	ARROW	Cable Staple Gun - Steel	10mm (3/8") - 14mm (9/16")	6mm (1/4")
ART59	ARROW	Insulated Cable Staple Gun - Steel	17mm (11/16")	8mm (5/16")

ROUND CROWN STAPLES:
Quantity:
Suits:

ART18-10	ARROW	T18 [®] 10mm Staples - Carded	1000pc	AP961 / ART18
AP6111M	APEXON	(T18) 11mm Staples - Carded	1000pc	AP961 / ART18
ART18-12	ARROW	T18 [®] 11mm Staples - Carded	1000pc	AP961 / ART18
AP6210M	APEXON	(T25) 10mm Staples - Carded	1000pc	AP962 / ART25M
ART25-10	ARROW	T25 [™] 10mm Staples - Carded	1000pc	AP962 / ART25M
ART25-12	ARROW	T25 [™] 11mm Staples - Carded	1000pc	AP962 / ART25M
ART25-14	ARROW	T25 [™] 14mm Staples - Carded	1000pc	AP962 / ART25M

INSULATED STAPLES:
Quantity:
Insulator Size:
Suits:

ART591168	ARROW	T59 [™] Clear Staples - Carded	300pc	6mm (1/4") x 6mm (1/4")	ART59
ART591188	ARROW	T59 [™] Clear Staples - Carded	300pc	6mm (1/4") x 8mm (5/16")	ART59
ART591189BL	ARROW	T59 [™] Black Staples - Carded	300pc	8mm (5/16") x 8mm (5/16")	ART59
ART591189SS	ARROW	T59 [™] Stainless Steel Staples - Carded	300pc	8mm (5/16") x 8mm (5/16")	ART59



AP903
HD Industrial staple gun tacker



STTR110
HD staple gun tacker



AP913
HAMMERSHARK Hammer tacker



AP850B
HD staple gun tacker
Power adjustment control



AP1006HD-2M
6mm(1/4") T50 2000pk
staples



AP1008HD-5M
8mm(5/16") T50 5000pk
staples



AP1010HD-23M
10mm(3/8") T50 2350pk
staples



AP1012HD-4M
12mm(1/2") T50 4000pk
staples



AP961
Wire and Cable tacker



ART18
Wire and cable tacker



ART18-12
11mm Curved staples



AP6111M
11mm Divergent point staples



AP962
Wire and Cable tacker



ART25M
Wire and cable tacker



ART25-10
10mm Curved staples



AP6210M
10mm Divergent point staples



ART59
Pro. Insulated cable staple gun



ART591189SS
8mm Insulated
clear S/S staple



ART591168
6mm Insulated
clear staple



ART591189BL
8mm Insulated
black staple

22					
DOWELLING TOOLS:				dowel size	
PG650-00	PG	Dowelling jig - complete with 3 spacers and dowels	6mm 8mm 10mm		
DOWELLING TOOL JOINT KITS:					
PG681-00	PG	6mm Dowel joint kit - drill, centre points and dowels	6mm		
PG682-00	PG	8mm Dowel joint kit - drill, centre points and dowels	8mm		
PG683-00	PG	10mm Dowel joint kit - drill, centre points and dowels	10mm		
DOWEL CENTRE SETS:					
PG670-00	PG	Dowel centre set of 4	6mm		
PG675-00	PG	Dowel centre set of 4	8mm		
PG680-00	PG	Dowel centre set of 4	10mm		
DOWEL BITS:				size	length
PG630-06	PG	Dowel and woodwork bit - brad point	6mm	90mm	
PG630-08	PG	Dowel and woodwork bit - brad point	8mm	110mm	
PG630-10	PG	Dowel and woodwork bit - brad point	10mm	125mm	
PG630-12	PG	Dowel and woodwork bit - brad point	12mm	150mm	
PG620-00	PG	Dowel bit depth stop set of 3 - metal with grub screw			
FLUTED DOWEL PACKS:					size
PG655-10	PG	Fluted dowels - pack of 60 x 6mm	6mm		
PG655-20	PG	Fluted dowels - pack of 150 x 6mm	6mm		
PG662-10	PG	Fluted dowels - pack of 50 x 8mm	8mm		
PG662-20	PG	Fluted dowels - pack of 125 x 8mm	8mm		
PG665-10	PG	Fluted dowels - pack of 40 x 10mm	10mm		
PG665-20	PG	Fluted dowels - pack of 100 x 10mm	10mm		
PG665-05	PG	Fluted dowels - industrial pack of 1000	10mm		
WOOD JOINING BISCUITS:					
PG669-10	PG	Wood joining biscuits - pack of 50 x No 10	No 10		
PG669-20	PG	Wood joining biscuits - pack of 50 x No 20	No 20		
PG669-15	PG	Wood joining biscuits - industrial pack of 1000	No 10		
PG669-25	PG	Wood joining biscuits - industrial pack of 1000	No 20		



PG681-00
Dowel joint kit



PG682-00
Dowel joint kit



PG683-00
Dowel joint kit



PG650-00
Dowelling jig



PG620-00
Dowel bit depth stop set



PG630-06
Dowel bit



PG630-08
Dowel bit



PG630-10
Dowel bit



PG630-12
Dowel bit



PG680-00
Dowel centre set



PG655-20
6mm Fluted dowels



PG662-20
8mm Fluted dowels



PG665-20
10mm Fluted dowels



PG665-05
10mm Fluted dowels



PG669-10
No 10 Wood joining biscuits



PG669-20
No 20 Wood joining biscuits



PG669-25
No 20 Wood joining biscuits

MORSE QUIKSILVER® BANDSAW BLADE (CARBON) COILS:

code	height	thickness	teeth	blade type	length
CAB03.014T.HEF-100	1/8"	0.025"	14t	hard edge flex	100' (83.3m)
CAB06.004T.HEF-2	1/4"	0.025"	4t	hard edge flex	250' (83.3m)
CAB06.006T.HEF-2	1/4"	0.025"	6t	hard edge flex	250' (83.3m)
CAB10.003T.HEF-2	3/8"	0.025"	3t	hard edge flex	250' (83.3m)
CAB10.004T.HEF-2	3/8"	0.025"	4t	hard edge flex	250' (83.3m)
CAB10.006T.HEF-2	3/8"	0.025"	6t	hard edge flex	250' (83.3m)
CAB10.008T.HEF-2	3/8"	0.025"	8t	hard edge flex	250' (83.3m)
CAB13.003T.HEF-2	1/2"	0.025"	3t	hard edge flex	250' (83.3m)
CAB13.004T.HEF-2	1/2"	0.025"	4t	hard edge flex	250' (83.3m)
CAB13.006T.HEF-2	1/2"	0.025"	6t	hard edge flex	250' (83.3m)
CAB13.010T.HEF-2	1/2"	0.025"	10t	hard edge flex	250' (83.3m)
CAB13.018T.HEF-2	1/2"	0.025"	18t	hard edge flex	250' (83.3m)
CAB19.002H.HEF-2	3/4"	0.032"	2t	hard edge flex	250' (83.3m)
CAB19.003T.HEF-2	3/4"	0.025"	3t	hard edge flex	250' (83.3m)
CAB19.010T.HEF-2	3/4"	0.025"	10t	hard edge flex	250' (83.3m)
CAB25.1.30H.0R-2	1"	0.035"	1.30t hook	hard edge flex	250' (83.3m)

QUIKSILVER® HEF/HB

QUIKSILVER® HEF/HB WOOD MILL BLADES

Versatile blades offer high value in a variety of wood cutting applications. Blades are manufactured from a single piece of high carbon steel with individually hardened tooth tips.

APPLICATIONS

- ▼ Portable and stationary wood mills
- ▼ Single head and multi-head resaw systems
- ▼ Scragg mills

BLADE FEATURES

- ▼ Available in both flex back and hard back
- ▼ Flex back blades are more fatigue resistant
- ▼ Hard back blades offer straighter cuts
- ▼ Low cost-per-blade/low cost-per-cut
- ▼ Can be resharpened for longer tooth life



QUIKSILVER® HB

QUIKSILVER (HB) HARDBACK BLADES

Stiffer blades offer straighter cuts in wood and metal cutting. On metals, they are used for short production and maintenance applications.

APPLICATIONS

- ▼ Low alloy, easy-to-machine ferrous metals
- ▼ Non-ferrous metals:
 - Brass/copper
 - Bronze
 - Aluminum
 - Lead
- ▼ Wood
- ▼ Plastic
- ▼ Cork
- ▼ Composition board
- ▼ Plywood

BLADE FEATURES

- ▼ Manufactured from a single piece of high carbon steel with individually hardened tooth tips
- ▼ Low cost-per-blade/low cost-per-cut in wood and similar materials
- ▼ In metals; low cost-per-blade/higher cost-per-cut than bi-metal
- ▼ Stiffer than hard edge flex (HEF) blades due to a hardened and tempered backer
- ▼ Straighter cuts with heavier feed pressure than carbon HEF
- ▼ Will accept heavier feed pressure than carbon HEF
- ▼ Good on easy-to-machine metals and other easy-to-cut materials
- ▼ Not recommended for blade speeds exceeding 4000 sfm

QUIKSILVER® HEF

QUIKSILVER® (HEF) FLEXBACK BLADES

Ideal for wood production cutting and short production/maintenance/general purpose applications using low alloy steel and non-ferrous metals

APPLICATIONS

- ▼ Wood
- ▼ Plastic
- ▼ Cork
- ▼ Composition board
- ▼ Plywood
- ▼ Aluminum
- ▼ Non-ferrous metals
- ▼ Low alloy steel

BLADE FEATURES

- ▼ Manufactured from a single piece of high carbon steel with individually hardened tooth tips
- ▼ More fatigue resistant than carbon hard back
- ▼ Low cost-per-blade/low cost-per-cut in wood
- ▼ Low cost-per-blade/higher cost-per-cut in tougher materials
- ▼ Can be run at speeds up to 15,000 sfm

MORSE "M42" BANDSAW BLADE (BI-METAL) COILS:

code	height	thickness	teeth	blade type	length
M4213.014T.0R-2	1/2"	0.035"	14t	fixed tooth	250' (83.3m)
M4213.1014.0R-2	1/2"	0.035"	10/14t	variable tooth	250' (83.3m)
M4219.0610.0R-2	3/4"	0.035"	6/10t	variable tooth	250' (83.3m)
M4219.0406.PR-2	3/4"	0.035"	4/6t	variable tooth	250' (83.3m)
M4225.0406.0R-2	1"	0.035"	4/6t	variable tooth	250' (83.3m)
M4225.1014.0R-2	1"	0.035"	10/14t	variable tooth	250' (83.3m)
M4232.0203.PR-2	1-1/4"	0.042"	2/3t	variable tooth	250' (83.3m)
M4232.0304.PR-2	1-1/4"	0.042"	3/4t	variable tooth	250' (83.3m)
M4232.0406.PR-2	1-1/4"	0.042"	4/6t	variable tooth	250' (83.3m)
M4232.0812.0R-2	1-1/4"	0.042"	8/12t	variable tooth	250' (83.3m)
M4238.0203.PR-2	1-1/2"	0.050"	2/3t	variable tooth	250' (83.3m)
M4238.0304.PR-2	1-1/2"	0.050"	3/4t	variable tooth	250' (83.3m)
M4238.0406.PR-2	1-1/2"	0.050"	4/6t	variable tooth	250' (83.3m)
M4250.0304.PR-1	2"	0.063"	3/4t	variable tooth	150' (50.0m)

MORSE "MATRIX" BANDSAW BLADE (BI-METAL) COILS:

code	height	thickness	teeth	blade type	length
MAT10.004T.HK-2	3/8"	0.025"	4t	fixed tooth	250' (83.3m)
MAT10.008T.0R-2	3/8"	0.025"	8t	fixed tooth	250' (83.3m)
MAT10.1014.0R-2	3/8"	0.025"	10/14t	variable tooth	250' (83.3m)
MAT13.004T.HK-2	1/2"	0.025"	4t	fixed tooth	250' (83.3m)
MAT13.014T.0R-2	1/2"	0.025"	14t	fixed tooth	250' (83.3m)
MAT13.018T.0R-2	1/2"	0.025"	18t	fixed tooth	250' (83.3m)
MAT13.024T.0R-2	1/2"	0.020"	24t	wavy tooth	250' (83.3m)
MAT13.0610.0R-250	1/2"	0.025"	6/10t	variable tooth	250' (83.3m)
MAT13.0812.0R-2	1/2"	0.025"	8/12t	variable tooth	250' (83.3m)
MAT13.1014.0R-2	1/2"	0.025"	10/14t	variable tooth	250' (83.3m)
MAT1320.1014.0R-250	1/2"	0.020"	10/14t	variable tooth	250' (83.3m)
MAT1320.1418.0R-250	1/2"	0.020"	14/18t	variable tooth	250' (83.3m)
MAT19.008T.0R-2	3/4"	0.035"	8t	fixed tooth	250' (83.3m)
MAT19.014T.0R-2	3/4"	0.035"	14t	fixed tooth	250' (83.3m)
MAT25.014T.0R-2	1"	0.035"	14t	fixed tooth	250' (83.3m)
MAT25.0508.0R-2	1"	0.035"	5/8t	variable tooth	250' (83.3m)
MAT32.0610.0R-2	1-1/4"	0.042"	6/10t	variable tooth	250' (83.3m)



M42

Durability for higher production speeds on difficult to machine solids and heavy walled structures

APPLICATIONS

- ▼ Solids
- ▼ Heavy walled structures
- ▼ Carbon steels
- ▼ Alloy steels
- ▼ Some stainless steels
- ▼ Medium to heavy production machines

BLADE FEATURES

- ▼ Durability for higher production cutting
- ▼ Variable and straight pitch teeth
- ▼ Heat and wear resistance



M42



MATRIX II



MATRIX II

MATRIX II BI-METAL BLADES

Matrix II blades are ideal for cutting materials with easy to moderate machinability. Matrix II bi-metal band saw blades offer good value in maintenance shops and small fabricating shops.

APPLICATIONS

- ▼ Carbon steels
- ▼ Structural steels – A36
- ▼ Single piece
- ▼ Bundles
- ▼ Stacked pieces
- ▼ Interrupted cuts of:
 - Pipe and tubing
 - Angle and channel
 - Small and medium band saw machines

BLADE FEATURES

- ▼ Variable pitch teeth handle a wide range of application sizes
- ▼ Good general purpose metal cutting blade
- ▼ Moderate cost-per-blade low cost-per-cut

BIT HOLDERS:
Colour
Pack

BM-BHMW18RED2	STEALTHMOUNTS	Bit holder for Milwaukee M18	Red	2 pack
BM-BHMW12RED2	STEALTHMOUNTS	Bit holder for Milwaukee M12	Red	2 pack
BM-BHARORG2	STEALTHMOUNTS	Bit holder for Ridgid/AEG	Orange	2 pack
BM-BHDWYLW2	STEALTHMOUNTS	Bit holder for DeWalt	Yellow	2 pack
BM-BMHHRGN2	STEALTHMOUNTS	Bit holder for Hikoki/Metabo HPT	Green	2 pack
BM-BHFTGRN2	STEALTHMOUNTS	Bit holder for Festool	Green	2 pack
BM-BHMKBLU2	STEALTHMOUNTS	Bit holder for Makita	Blue	2 pack
BM-BHBOBLU2	STEALTHMOUNTS	Bit holder for Bosch	Blue	2 pack

BATTERY MOUNTS:
Colour
Pack

BM-BMMW18RED6	STEALTHMOUNTS	Battery mounts for Milwaukee M18	Red	6 pack
BM-BMMW12RED6	STEALTHMOUNTS	Battery mounts for Milwaukee M12	Red	6 pack
BM-BMHT22ORG6	STEALTHMOUNTS	Battery mounts for Hilti 22v	Orange	6 pack
BM-BMDW20YLW6	STEALTHMOUNTS	Battery mounts for DeWalt XR	Yellow	6 pack
BM-BMMHH18GRN6	STEALTHMOUNTS	Battery mounts for Hikoki/Metabo HPT	Green	6 pack
BM-BMFT18GRN6	STEALTHMOUNTS	Battery mounts for Festool 18v	Green	6 pack
BM-BMMK18BLU6	STEALTHMOUNTS	Battery mounts for Makita 18v	Blue	6 pack
BM-BMMK40BLU6	STEALTHMOUNTS	Battery mounts for Makita 40v	Blue	6 pack
BM-BMBO18BLU6	STEALTHMOUNTS	Battery mounts for Bosch 18v	Blue	6 pack
BM-BMRY184	STEALTHMOUNTS	Battery mounts for Ryobi 18v ONE	Black	4 pack
BM-BMEG56BLK4	STEALTHMOUNTS	Battery mounts for Ego 56v	Black	4 pack
BM-BMSBPBLK6	STEALTHMOUNTS	Battery mounts for Black+Decker/Porter	Black	6 pack
BM-BMST20BLK6	STEALTHMOUNTS	Battery mounts for Stanley V20	Black	6 pack
BM-BMRG18BLK6	STEALTHMOUNTS	Battery mounts for Ridgid/AEG 18v	Black	6 pack
BM-BMEOBLK6	STEALTHMOUNTS	Battery mounts for Ozito/Einhell 18v	Black	6 pack

TOOL MOUNTS:
Colour
Pack

BM-TMMW18RED4	STEALTHMOUNTS	Tool mounts for Milwaukee M18	Red	4 pack
BM-TMDW18YLW4	STEALTHMOUNTS	Tool mounts for DeWalt XR	Yellow	4 pack
BM-TMMK18BLU4	STEALTHMOUNTS	Tool mounts for Makita 18v	Blue	4 pack
BM-TMMK40BLU4	STEALTHMOUNTS	Tool mounts for Makita 40v	Blue	4 pack
BM-TMMW12BLK3	STEALTHMOUNTS	Tool mounts for Milwaukee M12	Black	3 pack
BM-TMMHH18BLK4	STEALTHMOUNTS	Tool mounts for Hikoki/Metabo HPT	Black	4 pack
BM-TMSTPCBLK4	STEALTHMOUNTS	Tool mounts for Black+Decker/Porter	Black	4 pack
BM-TMST20BLK4	STEALTHMOUNTS	Tool mounts for Stanley V20	Black	4 pack
BM-TMBO18BLK4	STEALTHMOUNTS	Tool mounts for Bosch 18v	Black	4 pack
BM-TMAR18BLK4	STEALTHMOUNTS	Tool mounts for Ridgid/AEG 18v	Black	4 pack
BM-OMATMBLK5	STEALTHMOUNTS	Air Tool Mount	Black	5 pack



BM-BHDWYLW2
Bit Holder - Dewalt XR



BM-BHMW12RED2
Bit Holder - Milwaukee M12



BM-BHMW18RED2
Bit Holder - Milwaukee M18



BM-BMHGHGRN2
Bit Holder - Hikoki/Metabo HPT



BM-BHMKBLU2
Bit Holder - Makita



BM-BHBOBLU2
Bit Holder - Bosch



BM-BHARORG2
Bit Holder - Ridgid/AEG



BM-BHFTGRN2
Bit Holder - Festool



BM-BMDW20YLW6
Battery mount for DeWalt



BM-BMMHH18GRN6
Battery mount for Hikoki/Metabo



BM-BMMK18BLU6
Battery mount for Makita 18v



BM-BMMK40BLU6
Battery mount for Makita 40v



BM-BMMW18RED6
Battery mount for Milwaukee M18



BM-BMMW12RED6
Battery mount for Milwaukee M12



BM-BMEG56BLK4
Battery mount for Ego



BM-BMSBPBLK6
Battery mount for B&D/Porter



BM-BMBO18BLU6
Battery mount for Bosch



BM-BMHT22ORG6
Battery mount for Hilti 22v



BM-BMFT18GRN6
Battery mount for Festool 18v



BM-BMRY184
Battery mount for Ryobi 18v ONE



BM-BMRG18BLK6
Battery mount for Ridgid & AEG 18v



BM-BMST20BLK6
Battery mount for Stanley V20



BM-TMDW18YLW4
Tool mount for DeWalt



BM-TMMHH18BLK4
Tool mount for Hikoki/Metabo



BM-TMST20BLK4
Tool mount for Stanley V20



BM-TMMW18RED4
Tool mount for Milwaukee M18



BM-TMMK18BLU4
Tool mount for Makita 18v



BM-TMMK40BLU4
Tool mount for Makita 40v



BM-TMSTPCBLK4
Tool mount for B&D/Porter



BM-TMBO18BLK4
Tool mount for Bosch



BM-TMAR18BLK4
Tool mount for Ridgid & AEG 18v



BM-TMMW12BLK3
Tool mount for Milwaukee M12



BM-OMATMBLK5
Air Tool Mount

CLEAT 'N' FEET / MOUNTING:
Colour
Pack

BM-OMCLFTBLK4	STEALTHMOUNTS	Cleat 'n' Feet Mounting system	Black	4 pack
BM-OMCLBLK6	STEALTHMOUNTS	Cleat 'n' Feet Mounting cleats	Black	6 pack
BM-PACF018	STEALTHMOUNTS	Cleat 'n' Feet Mounting feet	Black	8 pack

TOOL MOUNT SPACERS:
Size
Colour
Pack

BM-TMSPACERED6	STEALTHMOUNTS	Tool mount spacer for Milwaukee M18	12mm	Red	6 pack
BM-TMSPACEYLW6	STEALTHMOUNTS	Tool mount spacer for DeWalt XR	12mm	Yellow	6 pack
BM-TMSPACEBLU6	STEALTHMOUNTS	Tool mount spacer for Makita LXT	12mm	Blue	6 pack
BM-TMSPACEBLK6	STEALTHMOUNTS	Tool mount spacer	12mm	Black	6 pack

TRACK SAW SQUARES:
Colour
Pack

BM-TSSLFT1	STEALTHMOUNTS	Trax90XL Track Saw Square for Festool	Black	1 pack
BM-TSSSFT1	STEALTHMOUNTS	Trax90 Track Saw Square for Festool	Black	1 pack
BM-TSSLMK1	STEALTHMOUNTS	Trax90XL Track Saw Square for Makita	Black	1 pack
BM-TSSSMK1	STEALTHMOUNTS	Trax90 Track Saw Square for Makita	Black	1 pack

CHARGER MOUNTS:
Colour
Pack

BM-CMCMKB	STEALTHMOUNTS	Charger mount for Makita double charger	Black	2 pack
BM-CMCMKS	STEALTHMOUNTS	Charger mount for Makita single charger	Black	2 pack

BATTERY BOARDS:
Colour
Pack

BM-BDDW20H1	STEALTHMOUNTS	Battery Board for Dewalt XR	Black	1 pack
BM-BDMK18H1	STEALTHMOUNTS	Battery Board for Makita LXT	Black	1 pack

OTHER MOUNTS:
Colour
Pack

BM-BBBLK6	STEALTHMOUNTS	Bench belt	Black	6 pack
BM-OMCANBLK2	STEALTHMOUNTS	Aerosol Can Holder	Black	2 pack
BM-OMTBEBLK2	STEALTHMOUNTS	Tube Holders	Black	2 pack
BM-OMTBEV2BLK2	STEALTHMOUNTS	Tube Holders (new design)	Black	2 pack
BM-OMTRMBLKLF2	STEALTHMOUNTS	Track Mount	Black	2 pack
BM-MWPACCUPI	STEALTHMOUNTS	Milwaukee Packout Tumbler Mount	Black	1 pack
BM-OMLMSLBLK2	STEALTHMOUNTS	Level mounts Slim	Black	2 pack
BM-OMLMBLK2	STEALTHMOUNTS	Level mounts	Black	2 pack
BM-OMLMXLBLK2	STEALTHMOUNTS	Level mounts XL	Black	2 pack



BM-TMSPACEBLK6
Tool mount spacer - Black

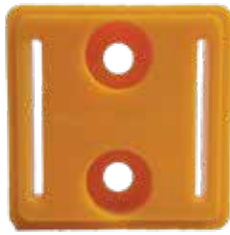

BM-TMSPACEYLW6
Tool mount spacer - Yellow



BM-TMSPACERED6
Tool mount spacer - Red



BM-TMSPACEBLU6
Tool mount spacer - Blue



BM-OMCLBLK6
Mounting System



BM-PACF018
Mounting Feet



BM-OMCLFTBLK4
Mounting Cleats



BM-OMCLBLK6
Bench Belt



BM-BDDW20H1
Battery Board - Dewalt



BM-BDMK18H1
Battery Board - Makita



BM-OMLMBLK2
Level Mounts



BM-OMTBEBLK2
Tube Mounts



BM-OMCANBLK2
Aerosol Can Holder



BM-CMCMKS
Charger Mount (Single)



BM-CMCMKB
Charger Mount (Double)



BM-OMTRMBLKL2
Track Mount



BM-MWPACCUP1
Milwaukee Packout
Tumbler Mount



Trax90XL Track Saw Square
Makita or Festool



Trax90 Track Saw Square
Makita or Festool



27				
FLAT ENGINEERS FILES:				length
TW250FLB	STANWAY	Flat file - bastard cut	250mm	
TW250FLB2C	STANWAY	Flat file - Second Cut	250mm	
HALF ROUND ENGINEERS FILES:				length
TW250HRB	STANWAY	Half round file - bastard cut	250mm	
ROUND ENGINEERS FILES:				length
TW250RDB	STANWAY	Round file - bastard cut	250mm	
MILL FILES:				length
TW250MIL	STANWAY	Mill file - One round edge bastard cut	250mm	
RASPS:				length
TW200WRB	STANWAY	Wood rasp - flat bastard cut	200mm	
TW250WRB	STANWAY	Wood rasp - half round bastard cut	250mm	
TW350HOR	STANWAY	Horse rasp - tanged with no handle	350mm	
AJP70764	JORGENSEN	Mini Rasp File	40mm	
AJP70760	JORGENSEN	Pocket Rasp File	150mm	
AJP70768	JORGENSEN	Pocket Rasp File Replacement Blade	150mm	
CHAINSAW FILES:				diameter length
TWCSS150-018	STANWAY	Chainsaw file - single cut	1/8" 150mm	
TWCSS200-532	STANWAY	Chainsaw file - single cut	5/32" 200mm	
TWCSS200-316	STANWAY	Chainsaw file - single cut	3/16" 200mm	
TWCSS200-732	STANWAY	Chainsaw file - single cut	7/32" 200mm	
TWCSS200-014	STANWAY	Chainsaw file - single cut	1/4" 200mm	
SLIM TAPER FILES:				length
TW100ST	STANWAY	Slim taper file - Clam pack	100mm	
TW150ST	STANWAY	Slim taper file - Clam pack	150mm	
TW100EST	STANWAY	Extra slim taper file - Clam pack	100mm	
TW150EST	STANWAY	Extra slim taper file - Clam pack	150mm	
MAGICUT FILES:				length
TW250MAG	STANWAY	Magicut file	250mm	
CANT SAW FILES:				length
TW200CAN	STANWAY	Cant saw file - Clam pack	200mm	
FILE HANDLES:				Length
TWF075	STANWAY	wood file handle - with metal ferrule	75mm	
TWF100	STANWAY	wood file handle - with metal ferrule	100mm	
TWF125	STANWAY	wood file handle - with metal ferrule	125mm	
TWF150	STANWAY	wood file handle - with metal ferrule	150mm	
FILE SETS:				Length
DRNF6	DRAPER	Needle files - set of 6	150mm	

FLAT ENGINEERS FILES



TW250FLB
250mm Flat
Bastard Cut File



TW250FLB2C
250mm Flat
Second Cut File

HALF ROUND ENGINEERS FILES



TW250HRB
250mm Half Round
Bastard Cut File

ROUND ENGINEERS FILES



TW250RDB
250mm Round
Bastard File

MILL FILES



TW250MIL
250mm Mill Bastard
File One Round Edge

CANT SAW FILES



TW200CAN
200mm Cant Saw File

RASPS



TW200WRB
200mm Hand
Wood Rasp File



TW250WRB
250mm Half Round
Wood Rasp File



TW350HOR
350mm Tanged
Horse Rasp

CHAINSAW FILES



TWCSS150-018
Chainsaw File
(150mm x 3.2mm)



TWCSS200-532
Chainsaw File
(200mm x 4mm)



TWCSS200-316
Chainsaw File
(200mm x 4.8mm)



TWCSS200-732
Chainsaw File
(200mm x 5.6mm)



TWCSS200-014
Chainsaw File
(200mm x 6.4mm)

SLIM TAPER FILES



TW100ST
100mm Slim
Taper File



TW150ST
150mm Slim
Taper File



TW100EST
100mm Extra Slim
Taper File



TW150EST
150mm Extra Slim
Taper File

MAGICUT FILES



TW250MAG
250mm Magicut
File



AJP70768
150mm Rasp Blade



TWF125
125mm Wood File Handle



AJP70764
Mini Rasp File



AJP70760
150mm Pocket Rasp File



DRNF6
6pc Needle File Set

SURFORM FILES:
length

ST21-295	STANLEY	Flat file	250mm
ST21-296	STANLEY	Plane	250mm
ST21-399	STANLEY	Block plane	140mm
DRMRBP140	DRAPER	Multi rasp block plane	140mm
ST21-115	STANLEY	Shaver tool	60mm
ST21-122	STANLEY	Planer file - plane/flat file combo	250mm

SURFORM FILE BLADES:

ST21-293	STANLEY	Blade - standard cut	250mm
ST21-393	STANLEY	Blade - fine cut	250mm
ST21-299	STANLEY	Blade - half round	250mm
ST21-508	STANLEY	Blade - metal/plastic	250mm
ST21-398	STANLEY	Blade - fine cut	140mm
DRXMRWB140	DRAPER	Multi rasp Plane replacement blade	140mm

ROCK PICKS:
size

E322P	ESTWING	Pointed tip rock pick - shock reduction nylon grip	22 oz
E323LP	ESTWING	Pointed tip rock pick - shock reduction nylon grip - Long handle	23oz
E-23	ESTWING	Blue replacement sheath for E314P, E322P, E323LP Rock Picks	

GOLD PANS:
size

E-BP10	ESTWING	Gold pan - hard wearing black plastic	250mm
E-BP12	ESTWING	Gold pan - hard wearing black plastic	300mm
E-BP14	ESTWING	Gold pan - hard wearing black plastic	350mm
E-BP16	ESTWING	Gold pan - hard wearing black plastic	400mm

HAND CLEANING WIPES:

TW-WIPE	STANWAY	"Tradie Wipes" Multi-purpose trade wipes 200mm x 250mm	100pc
---------	---------	--	-------



ST21-296
Plane



ST21-399
Block plane



ST21-293
Flat Blade



ST21-299
Half round blade



ST21-122
Planer file



ST21-295
Flat file



DRMRBP140
Multi Rasp Plane

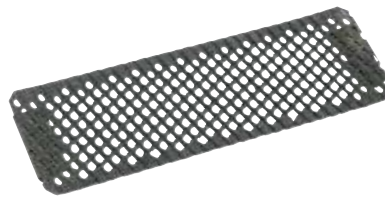

DRXMRWB140
Replacement blade



ST21-508
Metals/Plastics
Blade



E323LP
Pointed tip rock pick
Long handle



ST21-115
Shaver tool



E322P
Pointed tip rock pick



E-BP14
Plastic gold pan



TW-WIPE
Multi-purpose trade wipes

AXES & HATCHETS:
Weight
Length

E24A	ESTWING	Sportsmans axe - leather grip	1-1/2 lb	355mm
E44A	ESTWING	Campers hatchet with sheath	2-1/2 lb	400mm
E-E6TA	ESTWING	Black Eagle tomahawk axe - blue vinyl grip	756g	390mm
E-EBTA	ESTWING	Black Eagle tomahawk axe - black vinyl grip	756g	390mm
E-EBDBA	ESTWING	Black double faced tomahawk - black vinyl grip	38oz	390mm
E3FF4	ESTWING	Fireside Friend® wood splitting tool	4lb	356mm
DRFA-800	DRAPER	Felling axe - hickory handle	2.0kg	800mm
E45A	ESTWING	Campers axe with sheath - vinyl grip	3-1/2 lb	660mm

SPECIALTY KNIVES:
Length

E-EBM	ESTWING	Forged machete and saw		485mm
-------	---------	------------------------	--	-------

WEDGES:
Weight
Length

E-5	ESTWING	Sure split wedge - forged steel	4-1/2 lb	229mm
-----	---------	---------------------------------	----------	-------



E24A
Sportsmans axe



E44A
Campers hatchet



E-E6TA
Tomahawk axe



E-EBTA
Tomahawk axe



E-EBDBA
Double faced Tomahawk



E3FF4
Splitting tool



DRFA-800
Felling axe



E45A
Campers axe



E-EBM
Machete and saw



E-5
Sure-split wedge

CLAW HAMMERS - STEEL HANDLE:
overall length
weight

E316C	ESTWING	Curved claw hammer - shock reduction grip	330mm	16oz
E320C	ESTWING	Curved claw hammer - shock reduction grip	343mm	20oz
E322CR	ESTWING	Curved claw hammer - shock reduction grip	343mm	22oz
E328C	ESTWING	Curved claw hammer - English pattern head	343mm	24oz
E320S	ESTWING	Straight claw hammer - shock reduction grip	343mm	20oz
E20C	ESTWING	Curved claw hammer - Leather grip	343mm	20oz
E-MR20C	ESTWING	Sure-Strike all steel claw hammer	343mm	20oz
ST51-538	STANLEY	Fatmax Antivibe curved claw hammer		20oz

FRAMING HAMMERS - LONG HANDLE:

E322C	ESTWING	Curved claw framing hammer	406mm	22oz
E322S	ESTWING	Straight claw framing hammer	406mm	22oz
E328S	ESTWING	Straight claw framing hammer	406mm	28oz
E328SM	ESTWING	Straight claw framing hammer - Milled face	406mm	28oz
E330S	ESTWING	Straight claw framing hammer - Smooth face	406mm	30oz
E619S	ESTWING	Ultra series framing hammer - Blue handle	406mm	19oz
EB19S	ESTWING	Ultra series framing hammer - Black handle	406mm	19oz
E-ALBL	ESTWING	Al-Pro Aluminium framing hammer - Blue Handle	406mm	14oz
E-ALBK	ESTWING	Al-Pro Aluminium framing hammer - Black Handle	406mm	14oz

CLAW HAMMERS - FIBRE GLASS HANDLES:

E-MRF20C	ESTWING	Sure strike curved claw hammer - fibre glass handle	350mm	20oz
ST51-072	STANLEY	Curved claw hammer - fibre glass handle	355mm	20oz



E316C
Curved Claw



E320C
Curved Claw



E322CR
Curved Claw



E328C
Curved Claw - English Pattern



E320S
Straight Claw



ST51-072
Curved Claw - Fiberglass Handle



E322S
Framing Straight Claw



E20C
Curved Claw - Leather Grip



E-MR20C
Curved Claw



E328SM
Framing Straight Claw - Milled



ST51-538
Antivibe Curved Claw



E322C
Framing Curved Claw



E-MRF20C
Curved Claw - Fiberglass Handle



E619S
Framing Straight Claw



E328S
Framing Straight Claw



EB19S
Framing Straight Claw



E-ALBL
Aluminium Framing Straight Claw



E-ALBK
Aluminium Framing Straight Claw

BRICKLAYERS HAMMERS:
size weight

E320BLC	ESTWING	Chisel end Bricklayers hammer - nylon striking cap		20oz
E324BLC	ESTWING	Chisel end Bricklayers hammer - nylon striking cap		24oz
FAIDSH	FAITHFULL	Scutch Bricklayers hammer - double comb		28oz
FP138	FOOTPRINT	Scutch Bricklayers hammer - double comb		
FP5781	FOOTPRINT	Scutch hammer comb - smooth - 5 pack	25mm	
FP5782	FOOTPRINT	Scutch hammer comb - toothed - 5 pack	25mm	
FAICB525	FAITHFULL	Plain chisel bit - 5 pack	25mm	

CLUB HAMMERS:
handle size weight

E-MRF2LB	ESTWING	Forged head club hammer - fibre glass handle		2lb
E-MRF3LB	ESTWING	Forged head club hammer - fibre glass handle		3lb
E-B32LB	ESTWING	One piece forged club hammer - shock reduction nylon grip		2lb
E-B33LB	ESTWING	One piece forged club hammer - shock reduction nylon grip		3lb
E-B34LB	ESTWING	One piece forged club hammer - shock reduction nylon grip		4lb
E-MRF64E	ESTWING	Forged head Engineers hammer - fibre glass handle	350mm	4lb/64oz
FP119-4LB	FOOTPRINT	Fibreglass Handle Club Hammer		4lb

SLEDGE HAMMERS:
weight

E-SHF06	ESTWING	Forged head sledge hammer - fibreglass handle		6lb
E-SHF08	ESTWING	Forged head sledge hammer - fibreglass handle		8lb
E-SHF10	ESTWING	Forged head sledge hammer - fibreglass handle		10lb
E-SHF12	ESTWING	Forged head sledge hammer - fibreglass handle		12lb
E-SHW10	ESTWING	Forged head sledge hammer - hickory handle		10lb
E-SHW12	ESTWING	Forged head sledge hammer - hickory handle		12lb
DRSHW3	DRAPER	Sledge hammer wedges - sizes 4A, 4AH, 5		3 pack



FP5781
Plain scutch combs



FP5782
Toothed scutch combs



FAICB525
Plain Chisel bits



E320BLC
Bricklayers hammers



FAIDSH
Double scutch hammer



E-B33LB
One piece steel club hammer



FP138
Double scutch hammer



E-MRF64E
Fiberglass engineers hammer



E-MRF3LB
Fiberglass club hammer



DRSHW3
Sledge hammer wedges



FP119-4LB
Fiberglass club hammer



E-SHW12
Hickory sledge hammer



E-SHF06
Fiberglass sledge hammer

BALL PEIN HAMMERS:				weight
E316BP	ESTWING	One piece forging Polished face Ball pein hammer		16oz
E324BP	ESTWING	One piece forging Polished face Ball pein hammer		24oz
E332BP	ESTWING	One piece forging Polished face Ball pein hammer		32oz
DRBPH-08	DRAPER	Engineers ball pein hammer - hickory handle		8oz
DRBPH-12	DRAPER	Engineers ball pein hammer - hickory handle		12oz
DRBPH-16	DRAPER	Engineers ball pein hammer - hickory handle		16oz
DRBPH-24	DRAPER	Engineers ball pein hammer - hickory handle		24oz
DRBPH-32	DRAPER	Engineers ball pein hammer - hickory handle		32oz
WARRINGTON/CROSS PEIN HAMMERS:				Weight
FAIJWH8	FAITHFULL	Warrington hammer - hickory handle		8oz
FAIJWH12	FAITHFULL	Warrington hammer - hickory handle		12oz
FAIJWH16	FAITHFULL	Warrington hammer - hickory handle		16oz
DRJWH08	DRAPER	Warrington hammer - hickory handle		8oz
DRCPP-110	DRAPER	Cross pein pin hammer - hickory handle		110gm
RUBBER and PLASTIC MALLETS:			head size	Weight
FR200	FIELD	Solid rubber head mallet - steel handle	60mm	60mm
DRCRM-24	DRAPER	Combination rubber mallet - fibreglass handle		24oz
DRRM-24	DRAPER	Solid rubber head mallet - wood handle		24oz
DRRM-32	DRAPER	Solid rubber head mallet - wood handle		32oz
E-DFH12	ESTWING	Red & Yellow Plastic Mallet Hammer		12oz
WOODEN MALLETS and MAULS:				
FP130	FOOTPRINT	Carpenters wood mallet		113mm
GT113	STANWAY	Maul head complete with handle		125mm
SUNDRY STRIKING TOOLS:				weight
E3WC	ESTWING	Welding and chipping hammer		14oz
E3-239MM	ESTWING	Milled magnetic Latthammer - German pattern		21oz
MA37002	MAYHEW	Welders chipping hammer		12oz
MA37003	MAYHEW	Welders chipping hammer		16oz
HAMMER/STRIKING TOOL HANDLES:				length
DR11CH	DRAPER	Club hammer handle		225mm
DR16BP	DRAPER	Ball pein hammer handle - "A" grade hickory		400mm



DRJWH08
Warrington (joiners) hammer



DRBPH-24
Ball pein hammer



DRCPP-110
Cross pein pin hammer



E316BP
Ball pein hammer



FAIJWH8
Warrington cross pein hammer



E3-239MM
Milled magnetic latthammer



MA37003
Welders chipping hammer



E-DFH12
Mallet Hammer (Red & Yellow)



E3WC
Welders chipping hammer



DRCRM-24
Combi. Rubber mallet



DR16BP
Ball pein hammer handle



DRRM-24 & DRRM-32
Rubber mallet



DR11CH
Club hammer handle



FR200
Rubber mallet



GT113
Heavy maul with handle



FP130
Carpenters wood mallet

DEAD BLOW HAMMERS:
approx weight
face size

E-DH18	ESTWING	Dead head Dead blow mallet - black rubber head	500g	64mm
E-DH12N	ESTWING	Dead Head Dead blow mallet - Mar-resistant	335g	60mm
E-DH18N	ESTWING	Dead Head Dead blow mallet - Mar-resistant	500g	64mm
DRRDBH36	DRAPER	Rubber Dead Blow Hammer with Fibreglass Shafts	3.6kg	

REPLACEABLE FACE HAMMERS:

TH210-32	THOR	Replaceable face hammer - Copper and rawhide faces	680g	32mm
TH212-38	THOR	Replaceable face hammer - Copper and rawhide faces	1.10kg	38mm
TH214-45	THOR	Replaceable face hammer - Copper and rawhide faces	1.60kg	45mm
TH216-50	THOR	Replaceable face hammer - Copper and rawhide faces	2.50kg	50mm
TH222-70	THOR	Replaceable face hammer - Copper and rawhide faces	5.00kg	70mm
TH310-32	THOR	Replaceable face hammer - Copper/ copper faces	830g	32mm
TH312-38	THOR	Replaceable face hammer - Copper/ copper faces	1260g	38mm
TH314-45	THOR	Replaceable face hammer - Copper/ copper faces	1.94kg	45mm
TH316-50	THOR	Replaceable face hammer - Copper/ copper faces	2.50kg	50mm
TH708-25	THOR	Thorex Replaceable face hammer - White nylon faces	225g	25mm
TH710-32	THOR	Thorex Replaceable face hammer - White nylon faces	445g	32mm
TH712-38	THOR	Thorex Replaceable face hammer - White nylon faces	650g	38mm
TH714-45	THOR	Thorex Replaceable face hammer - White nylon faces	850g	45mm
TH716-50	THOR	Thorex Replaceable face hammer - White nylon faces	1230g	50mm

REPLACEMENT FACES:

THF-C32	THOR	Pure electrolytic copper		32mm
THF-C38	THOR	Pure electrolytic copper		38mm
THF-C45	THOR	Pure electrolytic copper		45mm
THF-C50	THOR	Pure electrolytic copper		50mm
THF-R32	THOR	Heavy duty Buffalo rawhide		32mm
THF-R38	THOR	Heavy duty Buffalo rawhide		38mm
THF-R45	THOR	Heavy duty Buffalo rawhide		45mm
THF-R50	THOR	Heavy duty Buffalo rawhide		50mm
THF-N25	THOR	White nylon		25mm
THF-N32	THOR	White nylon		32mm
THF-N38	THOR	White nylon		38mm
THF-N45	THOR	White nylon		45mm
THF-N50	THOR	White nylon		50mm



THF-R45
Rawhide face



THF-C45
Copper face



THF-N45
Nylon face



TH708-25
Nylon/nylon faces



TH712-38
Nylon/nylon faces

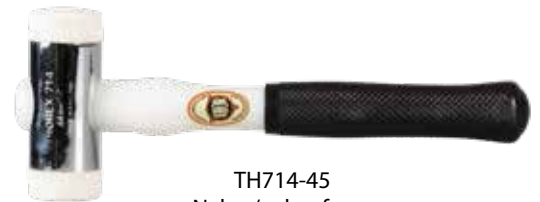

TH714-45
Nylon/nylon faces



TH716-50
Nylon/nylon faces



E-DH12N
Dead head dead blow



E-DH18
Dead head dead blow

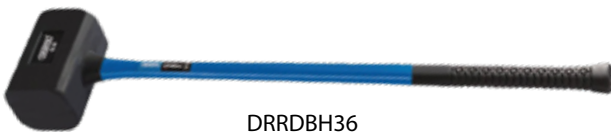

DRRDBH36
Rubber dead blow hammer



TH210-32
Copper/rawhide faces



TH310-32
Copper/copper faces



TH212-38
Copper/rawhide faces



TH312-38
Copper/copper faces



TH216-50
Copper/rawhide faces



TH316-50
Copper/copper faces

34					
TRIMMING KNIVES:					size
OLL1	OLFA	Standard snap off blade wheel knife			18.0mm
OLL5AL	OLFA	Comfort grip heavy duty cutter			18.0mm
OLL7	OLFA	Standard snap off blade wheel knife			18.0mm
OLXL2	OLFA	Extended reach snap off blade wheel knife			18.0mm
OLMXPL	OLFA	ALUMINIUM snap off blade wheel knife			18.0mm
OLMXPAL	OLFA	ALUMINIUM snap off blade auto knife			18.0mm
OLH1	OLFA	Heavy duty snap off blade knife			25.0mm
OLXH1	OLFA	X-BLADE Snap off blade wheel knife			25.0mm
OLXHAL	OLFA	X-BLADE Snap off blade auto knife			25.0mm
OLSK4	OLFA	Self retracting safety knife			17.5mm
OLSK10	OLFA	Stretch wrap cutter			17.8mm
OLSK12	OLFA	All Stainless steel self retractable knife			17.5mm
OLSK16	OLFA	Quick-Change Concealed Blade Safety Knife			
OLAK5	OLFA	Designer art knife with 30 blades			
USB117-53	US BLADE	Trimming knife with 3 blades - Retractable blade			
ST10-099	STANLEY	Trimming knife - Retractable with 3 blades			
TRIMMING KNIFE BLADES:			quantity	size	
OLLB10B	OLFA	Standard snap-off blade	10 pk	18.0mm	
OLLB50B	OLFA	Standard snap-off blade	50 pk	18.0mm	
OLLB10B	OLFA	EXCEL BLACK snap-off blade	10 pk	18.0mm	
OLSKB2	OLFA	Safety knife blades	5 pk	OKSK4	
OLSKB2S	OLFA	Stainless steel Safety knife blade	10 pk	OKSK12	
OLSKB10	OLFA	Safety knife blades	10 pk	OLSK10	
OLSKB16	OLFA	Quick-Change Concealed Blade	10 pk	OLSK16	
OLKB25	OLFA	Replacement blades for OLAK1	25 pk		
OLKB5-30B	OLFA	Replacement blades for OLAK5	30 pk		
OLHB5B	OLFA	Standard snap-off blade	5 pk	25.0mm	
OLHB20	OLFA	Standard snap-off blade	20 pk	25.0mm	
OLHBB5B	OLFA	EXCEL BLACK snap-off blade	5 pk	25.0mm	
USB112-5	US BLADE	Trimming knife blade - Heavy duty	5 pk	USB117-53	
USB120-01	US BLADE	Trimming knife blade - Heavy duty	100 pk	USB117-53	
ST1991-5	STANLEY	Standard Trimming knife blade	5 pk	ST10-099	
ST1991-100	STANLEY	Standard Trimming knife blade	100 pk	ST10-099	
ST1992-5	STANLEY	Heavy duty Trimming knife blade	5 pk	ST10-099	
ST1992-10	STANLEY	Heavy duty Trimming knife blade	10 pk	ST10-099	
ST1992-100	STANLEY	Heavy duty Trimming knife blade	100 pk	ST10-099	
ST1996H-5	STANLEY	Hooked Trimming knife blade	5 pk	ST10-099	
ST1996H-100	STANLEY	Hooked Trimming knife blade	100 pk	ST10-099	
ROTARY / SUNDRY CUTTING KNIVES / SHARPENERS			quantity	size	
FP2022	FOOTPRINT	Shoe knife - broad point			
FP2220	FOOTPRINT	Linoleum Knife			
FP949	FOOTPRINT	Marking knife			
OL45C	OLFA	Rotary linoleum cutter		45.0mm	
OLRB45-10	OLFA	Rotary cutter blade	10 pk	45.0mm	
TW-INSS	STANWAY	LANSKY Deluxe Quick Edge Knife Sharpener			
PAINTERS KNIVES:					
FP2030	FOOTPRINT	Putty knife			
FP182	FOOTPRINT	Hacking knife			



OLXL2
18mm Extended reach Snap-off knife



OLL5AL
18mm Snap-off knife



OLAK5
Deluxe art knife



OLL1
18mm Snap-off knife



OLH1
25mm Snap-off knife



OLSK10
Stretch wrap cutter



OLL7
18mm Snap-off knife



OLXH1
25mm Snap-off knife



OLSK12
All stainless safety knife



OLMXPL
18mm Snap-off knife



OLXHAL
25mm Auto-lock Snap-off knife



USB117-53
Trimming knife



OLMXPAL
18mm Auto-lock Snap-off knife



OLSK4
Self-retract safety knife



ST10-099
Trimming knife



OLSK16
Quick-change blade cutter



FP2030
Putty knife



FP949
Marking knife



FP2022
shoe knife



FP182
hacking knife



OL45C
Rotary linoleum cutter



TW-INSS
Knife Sharpener



USB120-01
HD Trimming blade
100 pack



OLLB
18mm blade
10 & 50 pack



OLHB
25mm blade
5 & 20 pack



OLSKB2
Safety knife blade
5 pack



OLSKB25
SS safety knife blade
10 pack



OLSKB16
Quick-change
blade 10 pack



OLLBB10B
18mm H/D blade
10 pack



OLHBB
25mm H/D blade
5 pack



OLKB25
Blade for OLAK1
25 pack



OLKB5-30B
Blade for OLAK5
30 pack



ST1991
Trimming blade
5 & 100 pack



ST1992
H/D Trimming blade
5, 10 & 100 pack



ST1996
Hooked blade
5 & 100 pack



OLSKB10
Safety knife blade
10 pack



OLRB45-10
Rotary blade
45mm 10 pack



USB112-5
Trimming blade
5 pack

STRIPPING KNIVES:
size

FP2015-25	FOOTPRINT	Stripping knife - forged steel	25mm
FP2015-38	FOOTPRINT	Stripping knife - forged steel	38mm
FP2015-50	FOOTPRINT	Stripping knife - forged steel	50mm
FP2015-75	FOOTPRINT	Stripping knife - forged steel	75mm
FP2015-100	FOOTPRINT	Stripping knife - forged steel	100mm
LG2000-100	STANWAY	Wall scraper - stainless steel	100mm
LG2000-150	STANWAY	Wall scraper - stainless steel	150mm

SCRAPING and SANDING TOOLS:

HD14	HAYDN	Genius corner scraper - tungsten carbide blade	14mm
HDX14-14	HAYDN	Genius scraper blade - tungsten carbide	14mm
HD50	HAYDN	Genius all purpose scraper - tungsten carbide blade	50mm
HDX50-50	HAYDN	Genius scraper blade - tungsten carbide	50mm
FP241	FOOTPRINT	Cabinet scraper set of 3 - (150 x 75mm) (138 x 63.5mm) (200 x 50mm)	
MT720	MARSHALLTOWN	Universal floor/wall scraper with handle	356mm x 100mm
MT720B	MARSHALLTOWN	Replacement 356mm blade for MT720	356mm x 100mm
MT820	MARSHALLTOWN	Universal floor/wall scraper with handle	500mm x 100mm
MT820B	MARSHALLTOWN	Replacement 500mm blade for MT820	500mm x 100mm
MTFFS7	MARSHALLTOWN	Floor scraper with handle	177mm
ST28-593	STANLEY	Window Scraper - Heavy Duty trimming knife blade	
DR111-05	DRAPER	Retractable Window Scraper with x 5 Blades	
USB111-05	US BLADE	Safety blade scraper with 5 blades	
USB111-04	US BLADE	Safety scraper replacement blade - pack of 10	
MM1660	MONUMENT	Cork sanding block	110mm x 63mm x 30mm

STAINLESS STEEL STRIPPING KNIVES



LG2000-100
100mm

LG2000-150
150mm

FORGED STEEL STRIPPING KNIVES



FP2015-25
25mm

FP2015-38
38mm

FP2015-50
50mm

FP2015-75
75mm

FP2015-100
100mm



HD14
14mm Corner scraper

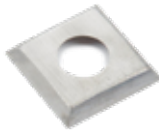

HDX14-14
14mm Scraper blade



HD50
50mm Scraper



HDX50-50
50mm Scraper blade



ST28-593
Window Scraper



ST1991-5
Replacement Blade **Pg 34**

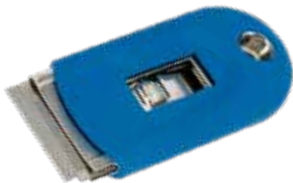

DR111-05
Retractable Window Scraper
with x5 Blades



USB111-05
Safety Scraper
with x5 Blades



USB111-04
Safety Scraper Blade



MM1660
Cork sanding block



FP241
3pc Cabinet Scraper set



MT820
Floor scraper with handle
500 x 100 x 1524mm



MT820B
Floor scraper blade
100mm x 500mm



BUILDERS LINES and CORDAGE:
length

CM80	STANWAY	Braided nylon string line - White	80m
CM80P	STANWAY	Braided nylon string line - Pink	80m
CM80Y	STANWAY	Braided nylon string line - Yellow	80m
CM80FL	STANWAY	Braided nylon string line - Fluorescent pink/yellow	80m
TWHS6-15	STANWAY	Sash window cord	15m x 6.4mm
TWHS8-15	STANWAY	Sash window cord	15m x 7mm
TWHANKPP4-15	STANWAY	Yellow all purpose tie down rope	15m x 4mm
TWHANKPP7-15	STANWAY	Yellow all purpose tie down rope	15m x 7mm
TWTWSISAL-GDN	STANWAY	Natural fibre garden twine	120m
TWSTR-COTTON60	STANWAY	All purpose cotton string	60gm

CHALK LINES:

KSK1	KESON	Aluminium case chalk line	30m
KSK1CB	KESON	Aluminium case chalk line - with 4oz blue chalk	30m
KSG150BOLD	KESON	Giant chalk line	50m
KSRL100	KESON	Chalk line string replacement	33m
TWCHALK3	STANWAY	ABS/Rubber case chalk line with 4oz blue chalk - 6x speed	30m
TWCHALK4	STANWAY	ABS/Rubber case chalk line with 4oz blue chalk - 6x speed	30m
ZE8192-1	STANWAY	Magnesium case chalk line with 60g chalk bag	30m
ZE8197-1	STANWAY	Magnesium case chalk line with 60g chalk bag - 5x speed	30m
ST47-099	STANLEY	Aluminium case chalk line	30m
ST47-140	STANLEY	Fatmax ABS/Rubber chalk line reel	30m
ST47-440	STANLEY	Plastic case chalk line	30m
ST47-464	STANLEY	Combo Chalk Line Set - 3pc	30m
ST47-681	STANLEY	Layout set - 3:1 Chalk line, chalk and line level	30m

CHALK:

KS4R	KESON	Plastic bottle dispenser - RED	4oz	113g
KS4B	KESON	Plastic bottle dispenser - BLUE	4oz	113g
KS4W	KESON	plastic bottle dispenser - WHITE	4oz	113g
KS8R	KESON	Plastic bottle dispenser - RED	8oz	228g
KS8B	KESON	Plastic bottle dispenser - BLUE	8oz	228g
KS8Y	KESON	Plastic bottle dispenser - YELLOW	8oz	228g
KS8W	KESON	Plastic bottle dispenser - WHITE	8oz	228g
KS8GO	KESON	Plastic bottle dispenser - GLO ORANGE	8oz	228g
KS8BK	KESON	Plastic bottle dispenser - BLACK	8oz	228g
KS105R	KESON	Plastic bottle dispenser - RED	5lb	2.24kg
KS105B	KESON	Plastic bottle dispenser - BLUE	5lb	2.24kg
KS105W	KESON	Plastic bottle dispenser - WHITE	5lb	2.24kg
KS105Y	KESON	Plastic bottle dispenser - YELLOW	5lb	2.25kg
KS105GO	KESON	Plastic bottle dispenser - GLO ORANGE	5lb	2.24kg
KS105BK	KESON	Plastic bottle dispenser - BLACK	5lb	2.24kg

PLUMB LINES and PLUMB BOBS:

SWPB008B	SWANSON	Solid brass plumb bob	8oz	450g
SWPB016B	SWANSON	Solid brass plumb bob with spare tips	16oz	900g
ST47-974	STANLEY	Solid brass plumb bob	16oz	900g



KS4B 4oz Blue KS4R 4oz Red KS8GO 8oz Orange KS8W 8oz White KS8BK 8oz Black KS8R 8oz Red KS8B 8oz Blue KS8Y 8oz Yellow KS105BK 5lb Black KS105R 5lb Red



ZE8192-1 Chalk line ZE8197-1 Chalk line TWCHALK3 Chalk line set TWCHALK4 Chalk line set KSK1CB Chalk line set ST47-681 Layout set ST47-464 Chalk line set



KSK1 Chalk line ST47-099 Chalk line ST47-140 Chalk line ST47-440 Chalk line KSG150BOLD Giant chalk line KSRL100 Replacement 30m string



ST47-974 Brass plumb bob SWPB008B Brass plumb bob SWPB016B Brass plumb bob



TWHANKPP4-15 Tie down rope TWSH6-15 Window sash cord TWTWSISAL-GDN Garden twine TWSTR-COTTON60 Cotton string



CM80 White Builders line CM80Y Fluorescent Builders line CM80P Fluorescent Builders line CM80FL Fluorescent Builders line (assorted)

BUILDERS LEVELS:
length

JN1717-180	JOHNSON	Professional box beam level - 3 vials	(E70)	1800mm
SWSVB-060	SAVAGE	Box Beam Level - 3 vials		600mm
SWSVB-120	SAVAGE	Box Beam Level - 3 vials		1200mm
SWSVB-180	SAVAGE	Box Beam Level - 3 vials		1800mm
SWSVB-240	SAVAGE	Box Beam Level - 3 vials		2400mm
SB83S-1000	STABILA	Cast alloy Professional level - 3 vials		1000mm
SB96-0600	STABILA	Craftsman Pro level - 3 vials		600mm
SB96-0800	STABILA	Craftsman Pro level - 3 vials		800mm
SB96-1200	STABILA	Craftsman Pro level - 3 vials		1200mm
SB96-1800	STABILA	Craftsman Pro level - 3 vials		1800mm
SB96-2000	STABILA	Craftsman Pro level - 3 vials		2000mm
SB96-2400	STABILA	Craftsman Pro level - 3 vials		2400mm
ST43-524	STANLEY	Fatmax extreme box level - yellow colour		600mm
ST43-536	STANLEY	Fatmax extreme box level - yellow colour		900mm
ST43-548	STANLEY	Fatmax extreme box level - yellow colour		1200mm
ST43-572	STANLEY	Fatmax extreme box level - yellow colour		1800mm
ST43-648	STANLEY	Fatmax box level - silver colour		1200mm
ST43-672	STANLEY	Fatmax box level - silver colour		1800mm
SWPL0024	SWANSON	Speedlite Composite Level		600mm

MAGNETIC LEVELS:

SWSVT200	SAVAGE	Digital readout magnetic torpedo level - 2 vials		220mm
SWTL035M	SWANSON	Magnetic Pro-cast scaffolders level		250mm
SWTL021M	SWANSON	Magnetic Composite Torpedo Level		229mm
SWTL700M	SWANSON	Magnetic brightview torpedo level		229mm
SWTL001M	SWANSON	Magnetic aluminium torpedo level		229mm
JN1424-1000	JOHNSON	Magnetic scaffolders level - 3 vial		250mm
SB81SM-250	STABILA	Magnetic Scaffolders level - 2 vials		250mm
SRKLIXP48	STARRETT	Magnetic I-Beam Level - 3 vials		1200mm

SMALL LEVELS:

SB70-250	STABILA	Auminium 2-vial torpedo level		250mm
ST43-609	STANLEY	Fatmax Extreme V-base magnetic torpedo level		225mm
PT2493	PLUMTOOL	Adjustable gradient level		600mm
SWSL0002	SWANSON	Bullseye level		
SWPL001M	SWANSON	Magnetic post level		
SWCCL001	SWANSON	2-way caravan level		
SWLLA001	SWANSON	Line level - aluminium		100mm



SWSL0002
Bullseye level



SWPL001M
Post level



SWCCL001
Caravan level



SWLLA001
Line level



JN1424-1000
Magnetic Scaffolders level



SWTL035M
Magnetic Scaffolders level



SWTL001M
Magnetic aluminium torpedo level



ST43-609
Fatmax Magnetic torpedo level



SB815M-250
Magnetic Scaffolders level



SWTL021M
Magnetic Composite torpedo level



SWSVT200
Digital readout magnetic level



SB70-250
Aluminium Torpedo Level



SWTL700M
Magnetic brightview torpedo level



SWPL0024
Speedlite Composite Level



SB835-1000
Cast alloy Builders level



SWSVB-120
Box Beam Level



ST43-548
Fatmax extreme box level



SB96-1200
Craftsmen pro Builders level



ST43-648
Fatmax box level



SRKLXP48
Magnetic I-Beam Leel



PT2493
Adjustable Gradient level



JN1717-180
Box beam Builders level

ELECTRONIC WATER LEVELS:**Hose Length**

ZN-WL25	ZIRCON	Electronic water level	7.5m (25ft)
ZNXWL25-01	ZIRCON	Replacement Hose for ZN-WL25	7.5m (25ft)



ZN-WL25
Electronic Water level



ZNXWL25-01
Replacement Hose

AUTOMATIC DUMPY LEVELS:

JN40-6928	JOHNSON	<p>JN40-6928 Automatic Dumpy Level - with Tripod, Staff and carry/storage case</p> <p>Water and dust resistant for use in most weather conditions</p> <p>Wire hung, magnetically dampened compensator</p> <p>Magnification: 26 x</p> <p>Large, easy-to-use focusing knob</p> <p>Prism for bubble viewing, Top-mounted optical sight for quick reference</p> <p>Fine adjustment knobs on left and right sides with endless horizontal drive</p> <p>1:100 stadia for distance estimation, focusable cross hairs</p> <p>5/8" - 11 threads for standard tripods</p>
-----------	---------	---

CROSS LINE LASER LEVELS:

batteries

JN40-6616	JOHNSON	<p>Tiling and flooring laser</p> <p>Generates two laser lines on floor at 90° angle for surface layout including tiles, stone, brick, carpet and hardwood flooring</p> <p>Angles are easily established with built in protractor</p>	2x AA
-----------	---------	--	-------

ACCESSORIES FOR LASER LEVELS:

length

batteries

JN40-6796	JOHNSON	<p>Elevating tripod with 1/4" - 20 thread</p> <p>Tripod to fit JN40-6648 models</p> <p>Height range: 400mm - 1275mm</p> <p>Aluminium construction, Pan and tilt head for use at any angle</p> <p>Ideal for mounting cross-lines and 360° lasers</p> <p>Extendable centre column</p>	1275mm
-----------	---------	---	--------



JN40-6616
Tiling and flooring laser



JN40-6796
Extendable tripod



JN40-6928
Automatic Dumpy Level

40				
SCANNERS and STUD SENSORS - CENTRE FINDING:				battery
ZN-I520	ZIRCON	MultiScanner® i520 OneStep® <i>WireWarning™Alert, Finds centre of wood/steel studs to 38mm deep, Scan for metal up to 76mm deep</i>		9v (required)
ZN-i65	ZIRCON	i65 Stud Sensor <i>WireWarning™Alert, Finds centre/edges of wood/steel studs to 38mm deep</i>		9v (required)
ZN-HD900	ZIRCON	HD900 Multiscanner® <i>Centre finding wall scanner with AC & metal scan and backlit LCD 4 detection modes for studs, deep studs, metal & hot electrical wiring The signal strength indicator distinguishes between shallow & deep targets Finds studs up to 38mm deep.</i>		9v (required)
SCANNERS and STUD SENSORS - EDGE FINDING:				battery
ZN-EDGE	ZIRCON	EDGE - Edge finding stud sensor <i>Finds edges of wood and metal studs up to 19mm deep</i>		9v (required)
ZN-HD35	ZIRCON	HD35 Stud sensor with WireWarning® detection <i>Finds metal or wood studs electronically to 19mm deep Easy to read display. Spotlight pointer for marking correct target</i>		9v (required)
ZN-HD55	ZIRCON	HD55 - Edge finding stud sensor with LCD display <i>Deep scan mode and AC Detection Finds edges of wood and metal studs up to 38mm deep</i>		9V (required)
METAL LOCATORS:				battery
ZN-MT6	ZIRCON	MT6 MetalliScanner Metal Locator <i>Locate rebar, pipes, conduit, and more up to 6" (152mm) deep.</i>		9v (required)
ELECTRONIC DISTANCE MEASURES:				battery
SRKLMX50	STARRETT	Laser distance meter <i>range 50mm - 50m, multiple measurement units, ± 1.5mm accuracy 3 different indirect measuring, LED backlight Automatic power off. IP54 rating.</i>		2x AA (required)
VISUAL INSPECTION CAMERAS and RECORDERS:				
DRWIFIENDO	DRAPER	Wi-Fi Endoscope Inspection Camera		
DRENOV2	DRAPER	Endoscope Inspection Camera		
MOISTURE METERS and DETECTORS:				battery
GNMM1E	GENERAL	LED Moisture Meter		9v (included)
DRMM1E	DRAPER	LCD Moisture Meter		4x LR44 (included)
GNMMD7NP	GENERAL	Pinless LCD moisture meter with Tricolour display		
GNMMD950	GENERAL	Pin/Pinless deep sensor moisture meter with spherical sensor and remote probe		9v (required)
ZN-WD100	ZIRCON	Standard water alert detector		9v battery (not included)
ZN-WDWIFI	ZIRCON	Water alert detector with WIFI connectivity		CR123A battery included
ZN-WDX	ZIRCON	Water alert detector with sensor cable and WIFI connectivity		CR123A battery included
TW-UTC15	UNI-T	Digital voltage tester		



ZN-I65
Stud Sensor



ZN-HD900
Multiscanner®



ZN-EDGE
Edge finding stud sensor



SRKLMX50
Laser distance meter



ZN-HD35
Stud sensor with
WireWarning® detection



ZN-HD55
Edge finding stud sensor
with LCD display



ZN-MT6
Metal Scanner



TW-UTC15
Digital voltage tester



ZN-WD100
Water alert detector



ZN-WDWIFI
Water alert detector
with WIFI connectivity



ZN-WDX
Water alert detector
with sensor cable



DRMM1E
LCD Moisture
Meter



GNMMD950
Deep sensor
moisture meter



GNMMD7NP
Pinless LCD
moisture meter



GNMM1E
LED Moisture
Meter



DRWIFIENDO
Wi-Fi Endoscope
Inspection Camera



DRENOV2
Endoscope
Inspection Camera

CAULKING TOOLS:

FAIMGHD	FAITHFULL	Heavy duty caulking gun	425cc
---------	-----------	-------------------------	-------

LUBRICATING TOOLS:
capacity

DROIL300	DRAPER	Force feed oil can	300ml
----------	--------	--------------------	-------

FASTY STRAP TIES/RATCHET TIE DOWNS:
length

FY127-060	FASTY	Assorted 60 piece strap tie tube display Contains 12 of each size: 1.0m 1.5m 2.0m 2.5m 3.5m	
FY121-8	FASTY	Strap tie Refill pack for display box - WHITE	1.0m
FY122-8	FASTY	Strap tie Refill pack for display box - YELLOW	1.5m
FY123-8	FASTY	Strap tie Refill pack for display box - BLUE	2.0m
FY124-8	FASTY	Strap tie Refill pack for display box - RED	2.5m
FY125-8	FASTY	Strap tie Refill pack for display box - BLACK	3.5m
TWB30	STANWAY	Bungy cord - hooks at both ends	300mm
TWB60	STANWAY	Bungy cord - hooks at both ends	600mm
TWB90	STANWAY	Bungy cord - hooks at both ends	900mm
GFBTD25	GFB	Ratchet tie down - 750kg weight capacity	25mm x 5.0m
GFBTD35	GFB	Ratchet tie down - 1500kg weight capacity	35mm x 6.0m
GFBTD50	GFB	Ratchet tie down - 2500kg weight capacity	50mm x 9.0m
GFBTD2PK	GFB	Ratchet tie down - 4 pack	25mm x 5.0m
GFBTD4PK	GFB	Ratchet tie down - 2 pack	25mm x 5.0m



DROIL300
Force feed oil can



FAIMGHD
caulking gun



GFBTD25
Ratchet tie down
750kg cap.



GFBTD35
Ratchet tie down
1500kg cap.



GFBTD50
Ratchet tie down
2500kg cap.



FY127-060
60pc Assorted tube display



GFBTD2PK
2pc Ratchet tie down set
400kg cap.



GFBTD4PK
4pc Ratchet tie down set
400kg cap.



FY121-8
1.0m strap ties



FY122-8
1.5m strap ties



TWB30
300mm Bungy cord



FY123-8
2.0m strap ties



FY124-8
2.5m strap ties



TWB60
600mm Bungy cord



FY125-8
3.5m strap ties



TWB90
900mm Bungy cord

MARKING OUT TOOLS - SCRIBERS:
length

GN80	GENERAL	Engineers Scriber - Straight and offset point	190mm
GN88	GENERAL	Pocket Scriber - Tungsten steel point	135mm
GNX88P	GENERAL	Replacement Tungsten Carbide Point for GN88	
GN88CM	GENERAL	Pocket Scriber - Magnetic	140mm

MARKING OUT TOOLS - CARPENTERS PENCILS:
colour

BP218H	BLACKEDGE	Carpenters pencil - Hard lead	Green
BP218M	BLACKEDGE	Carpenters pencil - medium lead	Red
BP218S	BLACKEDGE	Carpenters pencil - soft lead	Blue
DRCPS01	DRAPER	Carpenters pencil sharpener	
HU650100	HULTAFORS	Dry Marker with Holster	Graphite
HU650110	HULTAFORS	Dry Marker Refill - 10pc	Graphite
HU650150	HULTAFORS	Dry Marker Refill - 10pc	Red
HU650160	HULTAFORS	Dry Marker Refill - 10pc	Yellow
HU650220	HULTAFORS	Dry Marker Refill - 10pc	Graphite/Red/Yellow
HU650130	HULTAFORS	Dry Markers and Refill Counter Display Pack	

MARKING OUT TOOLS - CRAYONS:

TW100BK	STANWAY	Marking Crayon	MOQ of 12	Black
TW100W	STANWAY	Marking Crayon	MOQ of 12	White
TW100R	STANWAY	Marking Crayon	MOQ of 12	Red
TW100Y	STANWAY	Marking Crayon	MOQ of 12	Yellow
TW100BL	STANWAY	Marking Crayon	MOQ of 12	Blue

MARKING OUT TOOLS - CHALK:

HN010371	STANWAY	Engineers chalk with holder		White
TC100	TALC	Engineers chalk sticks - box of 144	box of 144 only	
VN48W	VINCO	Square chalk sticks - WHITE	box of 48 only	White

PERMANENT MARKING PENS:

TWLA70-BK	LEADERART	Point tip permanent marking pen	Black
TWLA70-BL	LEADERART	Point tip permanent marking pen	Blue
TWLA70-R	LEADERART	Point tip permanent marking pen	Red

MITRE BOXES:
capacity
angles

ST19-800	STANLEY	High impact plastic mitre box with back saw	100mm	45° 90° 45°
DRMBX-225	DRAPER	beechwood mitre box - without guides	70mm	45° 90° 45°
DRMBX-360	DRAPER	beechwood mitre box - without guides	110mm	45° 90° 45°



HU650100
30pc Dry Marker & Refill
Counter Display Pack



BP218M
Medium grade Carpenters pencil



TWLA70-BK
Black permanent markers



BP218H
Hard grade Carpenters pencil



TWLA70-R
Red permanent markers



BP218S
Soft grade Carpenters pencil



TWLA70-BL
Blue permanent markers



HU650100
DryMarker



HU650110
10pc Refill
Graphite



HU650150
10pc Refill
Red



HU650110
10pc Refill
Graphite



HU650220
10pc Refill
Mix



TW100R
Red
crayon



TW100BK
Black
crayon



TW100Y
Yellow
crayon



TW100W
White
crayon



TW100BL
Blue
crayon



GN88CM
Magnetic pocket scriber



GN88
Tungsten point pocket scriber



GN80
Straight/offset point scriber



GNX88P
Replacement Tungsten Carbide Point



HN010371
Chalk holder



ST19-800
Mitre box and saw



DRMBX-225
Wood mitrebox



DRMBX-360
Plastic mitrebox



VN48W
Chalk sticks



TC100
Engineers chalk



DRCPS01
Carpenters pencil sharpener

43				
MAGNIFYING TOOLS:				power
GN527	GENERAL	Eye loupe - for jewellers and instrument makers	#5 power lens	
GN553	GENERAL	Pocket magnifier - battery illumination	#4 power lens	
MIRROR TOOLS:				lens size
GN555	GENERAL	Inspection mirror - 200mm knurled handle	32mm round	
GN557	GENERAL	Inspection mirror - 263-375mm telescopic handle	56mm round	
GN560	GENERAL	Inspection mirror - 275-400mm telescopic handle	90mm x 50mm oblong	
MAGNETIC TOOLS:				length
GN383NX	GENERAL	Magnetic pick-up tool - telescopic	140mm - 585mm	
GN384N	GENERAL	Magnetic pick-up tool - Flex-O-stiff telescopic	450mm - 800mm	
PLANES:			Cutter width	length
ST12-004	STANLEY	Smooth plane	50mm	245mm
DR12-004	DRAPER	Smooth plane	50mm	250mm
ST12-005	STANLEY	Jack plane	50mm	355mm
ST12-220	STANLEY	Block plane - adjustable	42mm	180mm
DR12-220	DRAPER	Block plane - adjustable	42mm	174mm
AJP70700	JORGENSEN	Mini Block Plane	22mm	90mm
AJP70710	JORGENSEN	Low Angle Adjustable Mouth Block Plane	35mm	160mm
AJP70730	JORGENSEN	No.4 Smooth Plane	50mm	255mm
AJP70748	JORGENSEN	Corner Easing Plane (4 Blade Set)		170mm
AJP70755	JORGENSEN	Rasp Plane - Multi-Position Handle	41mm	315mm
AJP70758	JORGENSEN	Rasp Plane Replacement Blade	41mm	250mm
ST12-078	STANLEY	Rebate plane	38mm	315mm
PLANE REPLACEMENT PARTS:			Cutter width	Plane length
DRX12-004	DRAPER	Replacement blade for DR12-004	50mm	250mm
DRX12-220	DRAPER	Replacement blade for DR12-220	42mm	174mm
DRX12-004KIT	DRAPER	Replacement handle/screw set kit for DR12-004		
DRX12-220KIT	DRAPER	Replacement handle/screw set kit for DR12-220		
SPOKESHAVES:				
ST12-151	STANLEY	Adjustable spokeshave - flat base	54mm	
ST12-152	STANLEY	Adjustable spokeshave - round base	54mm	



GN555
Inspection mirror



GN557
Inspection mirror



GN560
Inspection mirror



GN553
Pocket magnifier



GN527
Eye loupe



GN384N
Telescopic pick-up tool



GN383NX
Telescopic pick-up tool



AJP70700
Mini block plane



AJP70710
Adjustable block plane



DR12-220
Adjustable block plane



AJP70730
No.4 Smooth Plane



D12-004
Adjustable block plane



AJP70755
Rasp Plane - Multi-Position Handle



AJP70748
Corner Easing Plane



ST12-078
Rebate plane



AJP70758
250mm Rasp Plane Blade



ST12-152
Round base spokeshave

DIAGONAL CUTTING PLIERS:
length

DR1906-160	DRAPER	Medium duty	Ergonomic plastic handle	160mm
DR1907-180	DRAPER	Medium duty	Ergonomic plastic handle	180mm
DRVDESC-200	DRAPER	Heavy duty	1000v insulated handles - VDE	200mm
CH3238	CHANNELLOCK	Heavy duty	Insulated handles	200mm
CH337I	CHANNELLOCK	Heavy duty	1000v insulated handles	190mm
CH437I	CHANNELLOCK	Heavy duty	Box joint - 1000v insulated handles	180mm
CH337G	CHANNELLOCK	Heavy duty	Plastic grip handles	175mm
CH338G	CHANNELLOCK	Heavy duty	Plastic grip handles	200mm
CH447G	CHANNELLOCK	Curved jaws	Box joint	175mm

END CUTTING PLIERS:

KP68-180	KNIPEX	Heavy duty	Plastic grip handles	180mm
KP68-200	KNIPEX	Heavy duty	Plastic grip handles	200mm
KP68-280	KNIPEX	Heavy duty	Plastic grip handles	280mm
DR1958-200	DRAPER	Medium duty	Ergonomic plastic handle	200mm
CH358	CHANNELLOCK	Heavy Duty	Plastic grip handles	203mm

LINESMANS PLIERS:

DR1947-180	DRAPER	Medium duty	Ergonomic plastic handle	180mm
DR1948-200	DRAPER	Medium duty	Ergonomic plastic handle	200mm
CH3248	CHANNELLOCK	Heavy duty	Insulated handles	200mm
CH348I	CHANNELLOCK	Heavy duty	1000v insulated handles	205mm
CH368G	CHANNELLOCK	Hi leverage	Cushion grip handles	213mm

LONG NOSE PLIERS:

ST89-870	STANLEY	Heavy Duty	Cushion grip handles	200mm
DR1926-160	DRAPER	Medium duty	Ergonomic plastic handle	160mm
DR1928-200	DRAPER	Medium duty	Ergonomic plastic handle	200mm
DRVDELP-200	DRAPER	Heavy duty	1000v insulated handles - VDE	200mm
CH326G	CHANNELLOCK	Heavy duty	Plastic grip handles	150mm
CH317G	CHANNELLOCK	Heavy duty	Plastic grip handles	175mm
CHE318	CHANNELLOCK	Heavy duty	Plastic grip handles	212mm
CHE388	CHANNELLOCK	Hi leverage	Plastic grip handles	190mm
CH3218	CHANNELLOCK	Heavy duty	Insulated handles	200mm
CH318I	CHANNELLOCK	Heavy duty	1000v insulated handles	205mm

CIRCLIP PLIERS:

DRCPS5	DRAPER	Combination circlip plier set - inside/outside circlips		165mm
--------	--------	---	--	-------

SPECIALTY PLIERS AND COMBOS:

CH718G	CHANNELLOCK	Heavy Duty	Duckbill Flat Long Nose Reach Plier	200mm
CH748	CHANNELLOCK	Heavy Duty	Long Reach End Cutting Plier	200mm
CHPG2	CHANNELLOCK	Heavy Duty	Insulated handles combo pack containing CH3238 and CH3248 pliers	200mm

End Cutters



KP68-200
End cutting pliers



CH358
End cutting pliers



DR1958-200
End cutting pliers



KP68-280
End cutting Concrete nippers

Linesman Pliers



CH368G
Linesmans pliers



DR1948-200
Linesmans pliers



CH3248
Insulated Linesmans pliers

Diagonal Cutters



CH338G
Diagonal cutting pliers



DR1906-160
Diagonal cutting pliers



DR1907-180
Diagonal cutting pliers



CH3238
Insulated Diagonal cutting



CH447G
Curved jaw cutting pliers

Long Nose Pliers



CH326G
Long nose pliers



CHE318
Long nose pliers



CHE388
Long nose pliers



CH317G
Long nose pliers



DR1926-160
Long nose pliers



DR1928-200
Long nose pliers



ST89-870
Long nose pliers



CH3218
Insulated Long nose pliers

Insulated Pliers



DRVDESC-200
1000V Diagonal cutting



DRVDELP-200
1000V Long nose pliers



CH3371
1000V Diagonal pliers



CH4371
1000V Box joint diagonal pliers



CH3481
1000V Linesman pliers



CH3181
1000V Long nose pliers



CHPG2
Linesman/Cutting plier combo
Insulated handles



CH718G
Duckbill Long Reach Plier



CH748
Long Reach End Cutting Plier



DRCPS5
Circlip plier set

GROOVE JOINT PLIERS:
Jaw Capacity
Length

DR0113-240	DRAPER	Water pump pliers	33mm	240mm
DR0114-300	DRAPER	Water pump pliers	55mm	300mm
DR0117-400	DRAPER	Water pump pliers	110mm	400mm
DRWPPSJ-245	DRAPER	Soft jaw water pump pliers	40mm	245mm
DRX38907	DRAPER	Replacement soft jaws for DRWPPSJ-245		
CH424G	CHANNELLOCK	Groove joint pliers - Straight jaws	12.70mm	113mm
CH426G	CHANNELLOCK	Groove joint pliers - Straight jaws	22.10mm	165mm
CH420G	CHANNELLOCK	Tongue and groove plier - straight jaw	38.10mm	241mm
CH430G	CHANNELLOCK	Groove joint pliers - Straight jaws	50.80mm	250mm
CH440G	CHANNELLOCK	Groove joint pliers - Straight jaws	57.15mm	300mm
CH460G	CHANNELLOCK	Groove joint pliers - Straight jaws	107.95mm	400mm
CH480G	CHANNELLOCK	Groove joint pliers - Straight jaws	139.70mm	500mm
CH432G	CHANNELLOCK	Groove joint pliers - Vee pattern jaws	50.80mm	250mm
CH442G	CHANNELLOCK	Groove joint pliers - Vee pattern jaws	57.15mm	300mm
CH422G	CHANNELLOCK	Tongue and groove plier - Vee pattern jaws	38.10mm	241mm
CHGL10	CHANNELLOCK	GRIPLOCK® Tongue & groove plier - vee jaws	31.75mm	241mm
CHGL12	CHANNELLOCK	GRIPLOCK® Tongue & groove plier - vee jaws	57.15mm	317mm
CH428X	CHANNELLOCK	SPEEDGRIP™ Tongue & groove pliers - straight jaw	30.48mm	214mm
CH430X	CHANNELLOCK	SPEEDGRIP™ Tongue & groove pliers - straight jaw	50.80mm	241mm
CH440X	CHANNELLOCK	SPEEDGRIP™ Tongue & groove pliers - straight jaw	58.93mm	300mm
KP87-125	KNIPEX	Cobra water pump pliers - Vee pattern jaws	27mm	125mm
KP87-150	KNIPEX	Cobra water pump pliers - Vee pattern jaws	32mm	150mm
KP87-180	KNIPEX	Cobra water pump pliers - Vee pattern jaws	32mm	180mm
KP87-250	KNIPEX	Cobra water pump pliers - Vee pattern jaws	51mm	250mm
KP87-300	KNIPEX	Cobra water pump pliers - Vee pattern jaws	67mm	300mm
KP87-400	KNIPEX	Cobra water pump pliers - Vee pattern jaws	89mm	400mm
RO70521	ROTHENBERGER	SPK Multigrip plier	34mm	175mm
RO70522	ROTHENBERGER	SPK Multigrip plier	43mm	250mm
RO70523	ROTHENBERGER	SPK Multigrip plier	48mm	300mm
RO00215	ROTHENBERGER	ROGRIP M Water pump plier	43mm	180mm
RO00216	ROTHENBERGER	ROGRIP M Water pump plier	60mm	250mm

GROOVE JOINT PLIER COMBO SETS:

CHGS-3	CHANNELLOCK	Groove joint pliers - Straight jaws - set of 3 Contains: CH426G, CH420G, CH440G	165mm 240mm 300mm	
CHGS-1SA	CHANNELLOCK	2pc Straight jaw T & G plier set with Ph #0 screwdriver Contains: CH426G, CH420G T & G pliers, 1x Ph #0 x 63.5mm screwdriver		



CHGS-1SA
Groove joint plier set



CHGS-3
Groove joint plier set



DRX38907
Replacement soft jaws



RO70522
SPK Multigrip pliers



RO00216
ROGRIP M Groove joint pliers



CH432G
Groove joint pliers



DR0114-300
Water pump pliers



KP87-250
Cobra water pump pliers



CH426G
Groove joint pliers



CH430X
Tongue & groove pliers



CH480G
Groove joint pliers



CH440G
Groove joint pliers



DRWPPSJ-245
Soft jaw Water pump pliers



CHGL10
GRIPLOCK® Groove joint pliers



CH460G
Groove joint pliers

46				
FENCING PLIERS:				length
CH085G	CHANNELLOCK	Heavy duty fencing pliers		263mm
DRFP-260	DRAPER	Heavy duty cushion grip fencing pliers		260mm
WIRE STRIPPING PLIERS:				
JOK20030	JOKARI	#20030 FKZ Flat cable wire stripper		
JOK19000	JOKARI	#19000 Spare blades for all cable knives		3 pack
CRIMPING AND SWAGING TOOLS:				
HT-CT350	HIT	Swaging tool - for aluminium and copper sleeves		1/16" 3/32" 1/8"
CH909	CHANNEL	Crimping plier - Cuts 10-22 AWG wire		241mm
WIRE STRIPPING/CRIMPER TOOLS:				length
JOK61000	JOKARI	#61000 Wire stripper & crimper		180mm
DRTH1827	DRAPER	Dual action wire stripper & crimper		210mm
DR4WCT215	DRAPER	4 Way Crimping Tool		215mm
SUNDRY PLIERS:				capacity length
DRRPP240	DRAPER	Revolving punch pliers - 6 punches 2mm - 4.8mm		240mm
DRBCP-175	DRAPER	Carpenters Pince - Ball and claw		175mm
CH212G	CHANNEL	Oil filter/PVC plier	63 - 95mm	304mm
CH215G	CHANNEL	Oil filter/PVC plier	63-139mm	394mm
CH410G	CHANNEL	Nutbuster tongue and groove plier	28mm	241mm
CH414G	CHANNEL	Nutbuster tongue and groove plier	51mm	342mm
PULLERS AND LIFTERS:				capacity
HNP450	HIT	Heavy duty nail puller - box joint and hardened jaws		
DRSCDP2	DRAPER	Twin suction cup lifter		40kg
HGPT04	HIT	Gear puller - 3 jaws		100mm
HGPT06	HIT	Gear puller - 3 jaws		150mm
HGP3	HIT	Gear puller - 2 jaws		75mm
HGP4	HIT	Gear puller - 2 jaws		100mm
HGP6	HIT	Gear puller - 2 jaws		150mm



HGPT06
3-leg gear puller



HGP4
2-leg gear puller



JOK19000
Spare blades for cutters



DR4WCT215
Wire crimper



JOK20030
Flat cable wire stripper



JOK61000
Wire stripper & Crimper



DRRPP240
Revolving punch pliers



HT-CT350
HD Swaging tool



JOK30500
Outer Insul. removal tool



DRFP-260
Fencing pliers



CH410G
Nutbuster tongue and groove plier



DRSCDP2
Twin suction lifter



HNP450
HD Nailpuller



DRBCP-175
Carpenter's Pincer



CH909
Crimping plier



CH085G
Fencing pliers



CH212G
Oil filter/PVC plier



DRTH1827
Wire Stripper/crimper

VIDEO INSPECTION and LOCATION SYSTEM:

RO02617	ROTHENBERGER	<p>Rocam 4 Plus video inspection camera</p> <p><i>For pipes from 40mm – 300mm</i></p> <p><i>With intergrated software for documentation</i></p> <p><i>and large removeable 10.4in touchscreen</i></p> <p><i>Transmission via WiFi, Micro-HDMI, Mini-USB, SD-card</i></p> <p><i>Self levelling and exchangeable camera heads</i></p>	30m cable length
RO02268	ROTHENBERGER	<p>ROSCOPE mini Inspection Camera (1000002268)</p> <p><i>120cm cable, 8.5mm Ø waterproof head, adjustable illumintaion</i></p> <p><i>180° rotatble picture, powered by 4x AA batteries</i></p>	

ROOT CLEARING SYSTEMS:

RO72904	ROTHENBERGER	<p>R750 Drain clearing machine</p> <p><i>For 20mm - 200mm diameter pipe, Machine only, no spirals included</i></p> <p><i>Perfectly suited for the cleaning of domestic connection</i></p> <p><i>and main pipes</i></p>	
RO72111	ROTHENBERGER	Basket only for R750 Drain clearing machine	
RO72915	ROTHENBERGER	Cable driver adapter for R650 drain machine	16mm
RO72413	ROTHENBERGER	Standard spiral only - 7.50m long	8mm
RO72221	ROTHENBERGER	Straight auger - 210mm long	22mm
RO72222	ROTHENBERGER	Funnel auger - 185mm long	55mm

VIDEO INSPECTION



RO02268
ROSCOPE mini

DRAIN CLEANING



RO72904
R750 Drain cleaning machine



RO72111
Basket only



RO72413
Standard spiral 8mm



RO72221
Straight auger



RO72915
Cable drive adapter 16mm



RO72222
Funnel auger

PLUMBERS DRAIN CLEANING TOOLS:
size

MM1219	BAILEY	19mm polypropylene drain rod - brass lockfast fitting	1200mm
MM1222	BAILEY	22mm polypropylene drain rod - brass lockfast fitting	1200mm
MM1819	BAILEY	19mm polypropylene drain rod - brass lockfast fitting	1800mm
MM1224	BAILEY	Rubber plunger - solid brass lockfast fitting	100mm
MM1226	BAILEY	Rubber plunger - solid brass lockfast fitting	150mm
MM1230	BAILEY	Double worm screw - solid brass lockfast fitting	50mm
MM1240	BAILEY	Half drop scraper - solid brass lockfast fitting	100mm
MM1246	BAILEY	Half drop scraper - solid brass lockfast fitting	150mm
MM1266	BAILEY	Drain brush - solid brass lockfast fitting	150mm
MM5690	BAILEY	Drain brush - Plastic stock & polypropylene bristles	100mm
MM1296	BAILEY	Spiral wire flue brush - solid brass lockfast fitting	150mm
MM1431	BAILEY	Drain cleaning wheel	
BY1793	BAILEY	Rotating handle - solid brass lockfast fitting	
BY1794	BAILEY	Retrieving tool - (rods and fittings)	

PLUMBERS DRAIN and PIPE CLEANERS - MANUAL:

TW-P25SM	STANWAY	T-Grip spinning drain cleaner (drain snake)	7.5m
TW-3RB	STANWAY	Professional closet auger - 12mm core wire	1.0mm
FR100	FIELD	Rubber force cup - handled	100mm
FR150	FIELD	Rubber force cup - handled	150mm
HA-P28	BAILEY	Pipe and sink cleaner - galvanised spring wire	1.8m
DKVIP1	D-KING	Water pulse drain cleaner	25-50mm
DKVIP2	D-KING	Water pulse drain cleaner	40-75mm
DKH34	D-KING	Water pulse drain cleaner	75-100mm
DK750	D-KING	Water pulse drain cleaner	75-150mm
PT3999	PLUMTOOL	Pump action drain cleaning plunger	
RO72070	ROTHENBERGER	ROPUMP super plus force pump - 2 adaptors	
DKMP500	D-KING	Master plunger	

ROTHENBERGER ROFROST FREEZE KIT SYSTEM / PARTS:
size

RO65030	ROTHENBERGER contains:	ROFROST® Dry ice set - 19pc RO65032 Handles x2, RO65033 high pressure hoses x2 10x pairs of freezer heads (2 for each pipe dimension) RO65049 stopper for one-sided freezing, RO65045 wrench, RO65046 internal hex screwdriver, RO65034 T-piece, RO65031 plastic carry case	
RO65032	ROTHENBERGER	ROFROST® CO2 hand grip - F	
RO65037	ROTHENBERGER	ROFROST® Freezer head only	16-18mm
RO65039	ROTHENBERGER	ROFROST® Freezer head only	28mm



RO65032
ROFROST® CO2 hand grip



ROFROST® CO2 freezer heads



RO65030
ROFROST® Dry ice set



BY1793
Rotating handle



BY1794
Retrieving tool



HA-P28
Pipe and sink cleaner

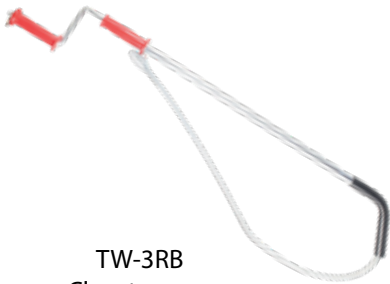

TW-3RB
Closet auger



TW-P25SM
Spinning drain and pipe cleaner



RO72070
ROPUMP® force plunger



DK750
Drain Cleaner



DKMP500
Master Plunger



FR100
Rubber force cup



PT3999
Pump action drain plunger



MM1296
Spiral wire flue brush



MM1266
Drain brush



MM1230
Double worm screw



MM1431
Clearing wheel



MM1240
Half drop scraper



MM1224
Rubber plunger



MM1222 Lockfast Drain rods

ALUMINIUM DRAIN TESTING PLUGS:				size	min range	max range	max psi
MM186-050	BAILEY	Drain testing plug		50mm	49 mm	60 mm	7psi
MM188-063	BAILEY	Drain testing plug		63mm	61mm	75 mm	7psi
MM187-075	BAILEY	Drain testing plug		75mm	73 mm	85 mm	7psi
MM206-090	BAILEY	Drain testing plug		90mm	85 mm	95 mm	7psi
MM189-100	BAILEY	Drain testing plug		100mm	94 mm	110 mm	7psi
MM1278-125	BAILEY	Drain testing plug		125mm	121 mm	138 mm	7psi
MM191-150	BAILEY	Drain testing plug		150mm	146 mm	163 mm	7psi
MM190-175	BAILEY	Drain testing plug		175mm	170 mm	195 mm	7psi
MM193-200	BAILEY	Drain testing plug		200mm	191 mm	211 mm	7psi
MM194-225	BAILEY	Drain testing plug		225mm	216 mm	235 mm	7psi
MM195-250	BAILEY	Drain testing plug		250mm	244 mm	260 mm	7psi
MM196-300	BAILEY	Drain testing plug		300mm	296 mm	314 mm	7psi
MM1280-350	BAILEY	Drain testing plug		350mm	340 mm	375 mm	5psi
MM1281-375	BAILEY	Drain testing plug		375mm	365 mm	400 mm	5psi
MM1282-400	BAILEY	Drain testing plug		400mm	390 mm	425 mm	5psi
MM1283-450	BAILEY	Drain testing plug		450mm	440 mm	475 mm	5psi
PT2149	PLUMTEST	Drain testing plug		100mm	94 mm	110 mm	7psi
PT2004	PLUMTEST	Offset drain testing plug		100mm	94 mm	110 mm	7psi
STEEL DRAIN TESTING PLUGS:				size	min range	max range	max psi
BY1964-040	BAILEY	Drain testing plug		40mm	36 mm	48 mm	7psi
BY1962-050	BAILEY	Drain testing plug		50mm	49 mm	60 mm	7psi
BY1963-075	BAILEY	Drain testing plug		75mm	73 mm	85 mm	7psi
BY1960-100	BAILEY	Drain testing plug		100mm	94 mm	110 mm	7psi
BY1961-150	BAILEY	Drain testing plug		150mm	146 mm	163 mm	7psi
BY1976-275	BAILEY	Drain testing plug		275mm	275 mm	305 mm	7psi
NYLON DRAIN TESTING PLUGS:				size	min range	max range	max psi
MM1370-013	BAILEY	Drain testing plug		13mm	13 mm	17mm	30psi
MM1371-019	BAILEY	Drain testing plug		19mm	20 mm	26 mm	30psi
MM1372-025	BAILEY	Drain testing plug		25mm	25 mm	32 mm	30psi
MM1373-032	BAILEY	Drain testing plug		32mm	34 mm	43 mm	30psi
MM1375-038	BAILEY	Drain testing plug		38mm	38 mm	45 mm	7psi
MM1376-050	BAILEY	Drain testing plug		50mm	50 mm	62 mm	7psi
MM1380-063	BAILEY	Drain testing plug		63mm	62 mm	70 mm	7psi
MM1377-075	BAILEY	Drain testing plug		75mm	74 mm	87 mm	7psi
MM1378-100	BAILEY	Drain testing plug		100mm	97 mm	100 mm	7psi
MM1381-125	BAILEY	Drain testing plug		125mm	122 mm	137 mm	7psi
MM1379-150	BAILEY	Drain testing plug		150mm	149 mm	165 mm	7psi
PUMP UP AND ELECTRIC DRAIN TESTING SYSTEMS:					min range	max range	max psi
PT2009	PLUMTEST	100mm	Inflatable Test Plug		100mm	145mm	15psi
MM1291-150	BAILEY	150mm	Inflatable Test Plug		150 mm	195 mm	8psi
PT9007	PLUMTEST	150mm	Inflatable Test Plug		150 mm	195 mm	8psi
PT9866	PLUMTEST	Test Bucket - 12 litres					
PT9871	PLUMTEST	Repair Kit for Plumtest PT9866 Test Bucket - 12pc					
RO60200	ROTHENBERGER	RP-50S Hand test pump <i>Suitable for oil, water and glycol</i> 720mm x 120mm x 300mm, 80kg					0 - 60 bar
RO61315	ROTHENBERGER	Replacement gauge only for the RO60200 RP-50 test pump					
RO60201	ROTHENBERGER	Replacement service kit only for RO60200 RP-50 test pump					
RO61309	ROTHENBERGER	Replacement service kit for the RO60200 RP-50 test pump					



MM1373-032
32mm Nylon



MM1376-050
50mm Nylon



MM1378-100
100mm Nylon



MM1379-150
150mm Nylon



BY1962-050
50mm All steel



BY1960-100
100mm All steel



BY1961-150
150mm All steel



BY1976-275
275mm All steel



MM186-050
50mm Aluminium



MM189-100
100mm Aluminium



MM193-200
200mm Aluminium



MM1281-375
375mm Aluminium



PT2009
Inflatable Test Plug 100mm



PT9007
Inflatable Test Plug 150mm



PT2149
100mm Aluminium



PT2004
100mm offset Aluminium



RO60200
RP-50S Hand test pump



PT9866
Test Bucket



RO61315
Gauge for RP-50S



RO60201
Service kit for RP-50S



PT9871
Service kit for PT9866

50				
PLUMBERS DRESSING TOOLS:				
	MM749	MONUMENT	Setting-in stick - Beechwood	
TEE EXTRACTORS: size				
	RO22127	ROTHENBERGER	Tee extractor set	15mm, 22mm, 28mm
	RO22038	ROTHENBERGER	Tee extractor with double V-Block	38mm
	RO22062	ROTHENBERGER	Tee extractor with double V-Block	3/4" OD
	RO05048	ROTHENBERGER	Spare extractor hook	15mm
PIPE REAMERS/DEBURRERS: for tube				
	MM365	MONUMENT	Int/ext deburring and reaming tool - soft metals	5mm - 38mm
	RO11006	ROTHENBERGER	Int/ext deburrer - Copper/plastic	3mm - 35mm
	RO21655	ROTHENBERGER	GRATFIX deburrer with No. 1 blade	
	RO21660	ROTHENBERGER	UNIGRAT deburrer with HSS blade	
	RO21652	ROTHENBERGER	Spare deburring blade for RO21655 & RO21660	
	RO00237	ROTHENBERGER	Int/ext deburrer - Copper/INOX (1500000237)	3mm - 35mm
	RO55020	ROTHENBERGER	ROCUT 110 basic mapping unit	32mm - 110mm
	RO55018	ROTHENBERGER	Inner deburrer with blade for ROCUT 110 - 160	
	TW481	STANWAY	Deburring tool - with extra blade	
	TWX481R	STANWAY	Replacement blades for TW481 - Bag of 5	
	GFB559	GFB	Chamfer Deburring Tool	3mm - 19mm
TAP/INTERNAL PIPE WRENCHES: Size				
	GN161R	GENERAL	Reversible ratchet tap wrench	1.6mm - 6.3mm
	GN162R	GENERAL	Reversible ratchet tap wrench	6.0mm - 12.5mm
	GN130	GENERAL	Tapered T Handle Reamer	3.175mm-12.7mm
	GN163	GENERAL	Plain tap wrench	1.6mm - 4.0mm
	GN164	GENERAL	Plain tap wrench	1.6mm - 6.3mm
	GN166	GENERAL	Plain tap wrench	6.0mm - 12.5mm
TEMPERATURE MEASURING INSTRUMENTS: range				
	PT1324	PLUMTEST	Digital thermometer - C° and F° scale	- 50° to 200° C
	RO88400	ROTHENBERGER	Digital thermometer - C° and F° scale	- 50° to 300° C
TAP RE-SEATING TOOLS: size				
	MM450P	MONUMENT	DIY Tap re-seating tool - plastic body and handle	19mm and 25mm
	MM499	MONUMENT	Professional Tap re-seating tool - steel T-bar handle	19mm and 25mm
	MMX499-12	MONUMENT	Tap re-seating tool cutter	12mm
	MMX499-16	MONUMENT	Tap re-seating tool cutter	16mm
	MMX499-19	MONUMENT	Tap re-seating tool cutter	19mm
	MMX499-25	MONUMENT	Tap re-seating tool cutter	25mm
	MMX499-32	MONUMENT	Tap re-seating tool cutter	32mm
	MMX499-38	MONUMENT	Tap re-seating tool cutter	38mm



RO00237
Universal int/ext deburrer
Copper/INOX (1500000237)



RO11006
Deburring and reaming tool
Copper/INOX



MM365
Deburring and reaming tool



GLB559
Chamfer Deburring Tool



TW481
Swivel head deburring tool



RO21655
GRATFIX Deburring tool



RO21660
UNIGRAT deburrer/reamer



TWX481R
Spare deburring blade



MM499
Professional Tap re-seating tool



GN161R
Reversible tap wrench



GN163
Standard tap wrench



RO21652
Spare deburring blade



RO55020
ROCUT 110
Basic Cmaping unit



MM450P
DIY Tap re-seating tool



GN130
Tapered Reamer T-Handle



PT1324
Digital thermometer



Tee extractor heads



RO88400
Digital thermometer



MM749
Setting-in stick



RO22127
Tee extractor set

51		TUBE / PIPE CUTTERS:			Spare Blade	Capacity
COPPER / THIN-WALLED METAL						
MM1715	MONUMENT	Autocut® Pipe Cutter (Zinc Diecast Body)	MMX269	15mm		
MM1721	MONUMENT	Autocut® Pipe Cutter (Zinc Diecast Body)	MMX269	21mm		
MM1722	MONUMENT	Autocut® Pipe Cutter (Zinc Diecast Body)	MMX269	22mm		
MM1741E	MONUMENT	Autocut® Pipe Cutter (Zinc Diecast Body) 2pc Set	MMX269	15mm & 21mm		
MM17127	MONUMENT	Autocut® Pipe Cutter (Zinc Diecast Body)	MMX292H	12.7mm (1/2")		
MM17190	MONUMENT	Autocut® Pipe Cutter (Zinc Diecast Body)	MMX292H	19mm		
MM15PC	MONUMENT	Auto Pipe Cutter (Plastic Body)	MMX1520	15mm		
MM21PC	MONUMENT	Auto Pipe Cutter (Plastic Body)	MMX1520	21mm		
ZE7325-1	STANWAY by ZENTEN	BASICK Pipe Cutter (Steel Body)	ZE6005-1	3-25mm		
RO70015	ROTHENBERGER	MINIMAX Tube Cutter	RO70017	3-28mm		
ZE7330-1	STANWAY by ZENTEN	BASICK Pipe Cutter (Steel Body)	ZE6005-1	3-30mm		
ZE7435-1	STANWAY by ZENTEN	KOMPAKT Pipe Cutter (Magnesium Body)	ZE6005-1	3-35mm		
RO70027	ROTHENBERGER	No.35 Tube Cutter	RO70017	6-35mm		
RO70029	ROTHENBERGER	No.42 Tube Cutter	RO70017	6-42mm		
RO70030	ROTHENBERGER	Automatic Copper Pipe Cutter	RO70017	6-67mm		
RO70142	ROTHENBERGER	Automatic Copper Tube Cutter	RO70057	50-127mm		
ZE7477-1	ZENTEN	KOMPAKT+ Quick Pipe Cutter (Aluminium Body)	---	50-127mm		
PLASTIC						
KP902210	KNIPEX	BiX® Plastic Pipe Cutter	KPX902210E01	20-50mm		
MM1112	MONUMENT	Autocut® Pipe Cutter (Plastic Body)	MM100B	40mm (1-1/2")		
MM1200	MONUMENT	Autocut® Pipe Cutter (Plastic Body)	MM100B	50mm (2")		
MM4120	MONUMENT	Autocut® Pipe Cutter (Green Plastic Body)	MM100B	20mm		
MM4125	MONUMENT	Autocut® Pipe Cutter (Green Plastic Body)	MM100B	25mm		
RO70031	ROTHENBERGER	Automatic Plastic Pipe Cutter PL1	RO70028	6-67mm		
ZE5026-1	STANWAY by ZENTEN	RAPTOR Plastic Pipe Cutter (Magnesium Body)	ZE5005-1	26mm		
ZE5042-1	STANWAY by ZENTEN	RAPTOR Plastic Pipe Cutter (Magnesium Body)	ZE5002-1	42mm		
ZE5063-1	STANWAY by ZENTEN	RAPTOR Plastic Pipe Cutter (Magnesium Body)	ZE5004-1	63mm		
RO52005	ROTHENBERGER	ROCUT 26TC Plastic Pipe Cutter	---	26mm		
RO52000	ROTHENBERGER	ROCUT 42TC Plastic Pipe Cutter	RO52042	42mm		
HA-VF32	STANWAY	Soft PVC Pipe Cutter	---	12-32mm		
HA-PC42	STANWAY	PVC Pipe Cutter	---	6-42mm		
MGB-63S	STANWAY	PVC Pipe Cutter	---	25-63mm		
STEEL / STAINLESS STEEL						
ZE7535-1	ZENTEN	INOX KOMPAKT Pipe Cutter (Magnesium Body)	ZE6005-9	3-35mm		
ZE7545-1	STANWAY by ZENTEN	INOX KOMPAKT Pipe Cutter (Magnesium Body)	ZE6005-9	3-45mm		
ZE7576-1	STANWAY by ZENTEN	INOX KOMPAKT Pipe Cutter (Magnesium Body)	ZE6005-9	6-76mm		
ZE6050-1	STANWAY by ZENTEN	Steel Pipe Cutter (Steel Body)	ZE6002-0	10-60mm		
OTHER SPARES:						
RO59000	ROTHENBERGER	Cutting Blade for Rothenberger PLASTICUT PVC				
RO55054	ROTHENBERGER	Cutting Wheel for Rothenberger Automatic Tube Cutter 125 PL				
MMX273	MONUMENT	Cutting Wheel for Monument Copper Pipe Cutters #264Y, #265B, #266E, #TC3				
MMX284	MONUMENT	Cutting Wheel for Monument Steel Pipe Cutters #271U, #272X				
DRCW1628	DRAPER	Cutting Wheel for Draper Tube Cutters #10579, #10580				
GNX121-2	GENERAL	Cutting Wheel for General Tools Tube Cutters #123R, #124, #135				
RO70056D	ROTHENBERGER	Cutting Wheel for Rothenberger Inox Tube Cutters 30 PRO, 35, 42 PRO				
RO70041	ROTHENBERGER	Spare Axle for Rothenberger Tube Cutters				
RO21652	ROTHENBERGER	Deburring Blade for Rothenberger Tube Cutters				
HAX-SPRING	STANWAY	Replacement Spring for Stanway PVC Pipe Cutter HA-PC42				

COPPER / THIN WALLED METAL



MM1715
Autocut® Pipe Cutter
(Zinc Diecast Body)



MM21PC
Auto Pipe Cutter
(Plastic Body)



ZE7325-1
BASICK Pipe Cutter



RO70015
MINIMAX Tube Cutter



ZE7330-1
BASICK Pipe Cutter



ZE7435-1
KOMPAKT Pipe Cutter



RO70027
No.35 Tube Cutter



RO70030
Automatic Copper Pipe Cutter



MMX269



MMX292H



MMX1520



ZE6005-1



RO70017



RO70057



KP902210
BiX® Plastic Pipe Cutter



MM1112
Autocut® Pipe Cutter
(Plastic Body)



MM4120
Autocut® Pipe Cutter
(Green Plastic Body)



RO70031
Automatic Plastic
Pipe Cutter PL1



ZE5026-1
RAPTOR Plastic Pipe Cutter



ZE5042-1
RAPTOR Plastic Pipe Cutter



ZE5063-1
RAPTOR Plastic Pipe Cutter



RO52005
ROCUT 26TC



RO52000
ROCUT 42TC



HA-VF32
Soft PVC Pipe Cutter



HA-PC42
PVC Pipe Cutter



MGB-63S
PVC Pipe Cutter



MM100B



RO70028



ZE5005-1



ZE5002-1



ZE5004-1



RO52042



ZE7545-1
INOX KOMPAKT Pipe Cutter



ZE7545-1
INOX KOMPAKT Pipe Cutter



ZE7576-1
INOX KOMPAKT Pipe Cutter



ZE6050-1
Steel Pipe Cutter



KPX902210E01



ZE6005-9



ZE6002-0

PLASTIC

STEEL

52			
TUBE EXPANDING / FLARING TOOLS:			capacity
RO222601	ROTHENBERGER	Universal flaring tool	3/16" - 5/8"
RO222402	ROTHENBERGER	Universal flaring tool - 45°	04mm - 16mm
SWAGING / EXPANDING TOOLS:			size
KG13	STANWAY	Swaging (Crox) tool	13mm
KG19	STANWAY	Swaging (Crox) tool	19mm
KG25	STANWAY	Swaging (Crox) tool	25mm
KG1319	STANWAY	Copper tube expanding (Drift) tool	13mm x 19mm
KG131925	STANWAY	Copper tube expanding (Drift) tool	13mm x 19mm x 25mm
RO12527	ROTHENBERGER	Expander power torque tool set	15, 22, 28mm
RO11078	ROTHENBERGER	A1 Copper tube expander	35mm - 103mm
RO11010	ROTHENBERGER	Tube expander head only - NZ copper	10mm
RO11012	ROTHENBERGER	Tube expander head only - NZ copper	12mm
RO11022	ROTHENBERGER	Tube expander head only - NZ copper	22mm
RO11028	ROTHENBERGER	Tube expander head only - NZ copper	28mm
RO11035	ROTHENBERGER	Tube expander head only - NZ copper	35mm
RO11042	ROTHENBERGER	Tube expander head only - NZ copper	42mm
TUBE BENDERS:			
BI15	STANWAY	Copper tube bender	15mm id tube
BI20	STANWAY	Copper tube bender	20mm id tube
BI15A	STANWAY	Copper tube bender - For Australian tube	15mm id tube (AUS)
BI20A	STANWAY	Copper tube bender - For Australian tube	20mm id tube (AUS)
MM860-19	MONUMENT	19mm internal bending spring	19mm id tube
MM2611	MONUMENT	Copper tube bender	6mm 8mm 10mm od tube



BI15
Copper tube bender



BI15A
Copper tube bender



MM2611
Copper tube bender



MM860-19
Internal bending spring



KG1319
13 x 19mm Swaging tool



KG131925
13x19x25mm Swaging tool



KG19
Crox tool

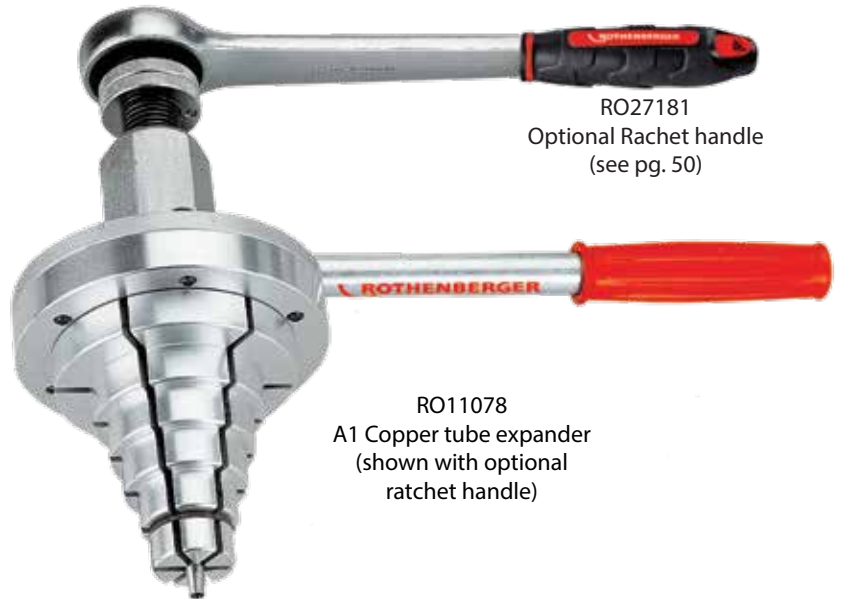

RO27181
Optional Ratchet handle
(see pg. 50)

RO11078
A1 Copper tube expander
(shown with optional
ratchet handle)



RO12527
ROCAM® EXPANDER SET
15, 22, 28mm



RO11028
Tube expander head



RO222601
Universal flaring tool



RO222402
Reeling flaring tool

53		PLUMBERS SPANNERS:		size	length
META2	MELCO	Tap spanner - Double ended tube	3/8" x 7/16"	100mm	
META11	MELCO	Tap spanner - Double ended tube	5/8" x 3/4"	125mm	
META20	MELCO	Tap spanner - Double ended tube	15/16" x 1"	175mm	
META23	MELCO	Tap spanner - Double ended tube	1-1/4" x 1-7/16"	190mm	
META24	MELCO	Tap spanner - Double ended tube	1-5/16" x 1-1/2"	190mm	
MET1011	MELCO	Tap spanner - Double ended tube	10mm x 11mm	175mm	
METM10	MELCO	Tap spanner - Double ended tube	12mm x 13mm	175mm	
METM5	MELCO	Tap spanner - Double ended tube	8mm x 9mm	125mm	
METIM7	MELCO	Tap spanner - Double ended tube	24mm x 27mm	150mm	
MESW12	MELCO	Element spanner - single end tube	2-1/16" A/F	(52mm)	
METW27	MELCO	Element spanner - Double end tube	1-1/4" x 1-1/2"		
MESET-1M	MELCO	Tap spanner set - Double ended tube	6mm - 19mm	Set of 7	
PT9828	PLUMTOOL	Flexible Mixer Tap Driver Kit - 6 piece Contains: 3/8 Drive Extra Long Sockets: 9, 10, 11, 12, 13mm 3/8 Flexible Drive (200mm long), 3/8 Hex Adaptor (40mm long)			
PTMT487	PLUMTOOL	Deluxe Mixer tap socket set - 13 piece Contains: Deep sockets: 8, 9, 10, 11, 12, 13, 14, 15mm Extension bars: 1x 150mm, 1x 250mm, universal joint x1, palm size ratchet x1, palm wrench x1			
TW-TUBESPANSET	STANWAY	Tube spanner set - holds 10, 11, 12, 13mm		Set of 4	
MGQ-10	JANSEN	Basin spanner - Super Ego style	10mm - 32mm	235mm	
HA-H116	JANSEN	Basin spanner	10mm - 32mm	235mm	
HA-H117	JANSEN	Basin spanner	10mm - 19mm	350mm	
MGQ-1116	JANSEN	Telescopic Basin spanner	10mm - 19mm	375mm	
MM349	MONUMENT	Basin spanner - 3 jaws	15mm - 42mm	235mm	
PLUMBERS SPECIALTY TOOLS:		size			
PTPC875	PLUMTOOL	Internal pipe cutter - Diamond blade - cuts pipe 40-150mm - 1/4" hex quick release	32mm x 100mm		
PT1349	PLUMTOOL	Replacement blade for internal pipe cutter			
PT8561	PLUMTOOL	Nipple cutter and catcher (Clear catcher)			
MRPVC18	MORSE	PVC Pipe cutting hand saw	450mm		
MRXPVC18	MORSE	PVC Pipe cutting hand saw replacement blade	450mm		
TWX250P	STANWAY	PVC Pipe cutting saw blade	250mm		
TM240P	TOPMAN	PVC pipe saw	240mm		
TMX240P-H	TOPMAN	pvc pipe saw - replacement handle			
TMXP24	TOPMAN	PVC pipe saw replacement blade	225mm		
TMXP26	TOPMAN	PVC pipe saw replacement blade	265mm		
TMXP30	TOPMAN	PVC pipe saw replacement blade	300mm		
TW225P	STANWAY	PVC pipe saw	225mm		
TWXP225	STANWAY	PVC pipe saw replacement blade	225mm		
TWXP300	STANWAY	PVC pipe saw replacement blade	300mm		
GN858	GENERAL	PVC pipe cable saw - stainless steel serrated wire			
PT1119	PLUMTEST	Water pressure gauge with hose - fits 1/2" & 3/4" hose tap	2500 kPa		
MM258	MONUMENT	Gas testing gauge	60 mb		
MM259	MONUMENT	Gas testing gauge	90 mb		
MM2350	MONUMENT	Soldering and brazing protection pad	300mm x 300mm		
MM2355M	MONUMENT	Omat soldering mat	300mm x 300mm		
ROMAPP	ROTHENBERGER	#56331 MAPP Gas bottle			
ROOXY	ROTHENBERGER	# 1400i Oxygen gas bottle			
MM3450	MONUMENT	Contractors Soldering & Brazing Torch	CGA600 Valve / 1" Thread		
RO35012	ROTHENBERGER	ROFIRE Swivel pro - Twin burner			
RO35644	ROTHENBERGER	SUPERFIRE 2 torch/super torch			
RO00529	ROTHENBERGER	ALLPRO mobile pro torch set (10000000529)	(MAP/PRO)		
RO00620	ROTHENBERGER	MAPP regulator for Allgas Pro (1000000620)			
RO00629	ROTHENBERGER	Oxygen regulator (1000000629)			
RO35303	ROTHENBERGER	Handle only for ALLGAS 2000			
RO31042	ROTHENBERGER	Flame reflector for the 65/15 model			
RO35430	ROTHENBERGER	Super Fire 3 Torch			
PT1527	PLUMTEST	Bonding strap with spring clamps	8-32mm CAP	1.4m x 16mm	
PT1914	PLUMTOOL	Stud punch out tool - Suits red arrommets	34mm diameter hole		
PT9241	PLUMTOOL	Multi-fit red arrommets - 100pk	suits 34mm diameter hole		
PT6420	PLUMTOOL	Multi-Head Whale Turn Up Tool	550mm handle		
PT6421	PLUMTOOL	Whale Turn Up ToolL			
PT1148	PLUMTOOL	Franz Tap	1/2" BSP		
PT2515	PLUMTOOL	Franz Tap	3/4" BSP		
PT1608	PLUMTEST	Digital Manometer Single Port	0 - 15 Kpa		
PT7276	PLUMTEST	Flow Rate Cup Tester	0 - 17 litres per minute		



MRPVC18
PVC pipe saw

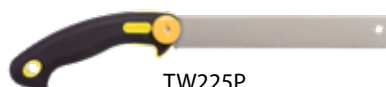

TW225P
PVC pipe saw



TM240P
PVC pipe saw



MRXPVC18
PVC pipe saw blade



TWXP225
PVC pipe saw blade



TMXP24
PVC pipe saw blade



MGQ-1116
Telescopic basin spanner



MM349
Basin spanner



PT1914
Stud Punch out tool

PT9241
Multi-fit grommet



MGQ-10
Basin spanner



HA-H116
Basin spanner



PTPC875
Internal pipe cutter



PT1349
Pipe cutter blade

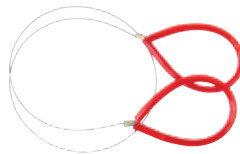

GN858
PVC pipe cable saw



PT8561
Nipple cutter and catcher



PT1608
Digital Manometer
with Single Port



META2
Tap Spanner



META11
Tap Spanner



META23
Tap Spanner



MESW12
Element spanner



METW27
Element spanner



RO31042
Flame reflector



MESET-1M
Tap spanner set



PT9828
Flexible Mixer Tap
Driver Kit



PTMT487
Deluxe Mixer Tap
Socket Kit



PT1527
Bonding Strap
with Spring Clamps

MM258
Gas testing gauge

PT7276
Flow Rate Cup Tester

PT1119
Water Pressure Gauge
on hose

RO00629
Oxygen Regulator

RO00620
MAPP Regulator

PT1148
Franz Tap



RO35644
SUPERFIRE 2 torch



RO35303
Handle only for
ALLGAS 2000



RO35012
ROFIRE twin burner



PT6420
Multi-Head whale tool

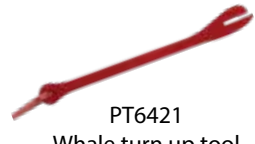

PT6421
Whale turn up tool



MM3450
Contractors Soldering
& Brazing Torch



MM2355M
Brazing protection
mat

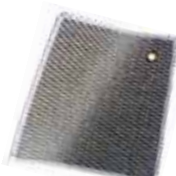

MM2350
Brazing protection mat



ROMAPP
MAPP Gas



ROOXY
Oxygen Gas



RO00529
Allpro mobile torch set

ARCH (WAD) PUNCHES:				size (inch)	size (mm)
GN1271-25	GENERAL	Arch (wad) punch - heat treated forged steel		1"	25mm
GN1271-32	GENERAL	Arch (wad) punch - heat treated forged steel		1-1/4"	32mm
MU1000-05	MAUN	Wad punch set of 9 with handle			5mm - 32mm
MU1001-05	MAUN	Wad punch set of 9 with handle			1/4" - 1"
HOLLOW PUNCHES:				size (inch)	size (mm)
GN1280-08	GENERAL	Hollow steel punch - forged steel		5/16"	8mm
GN1280-10	GENERAL	Hollow steel punch - forged steel		3/8"	10mm
GN1280-13	GENERAL	Hollow steel punch - forged steel		1/2"	13mm
GN1280-14	GENERAL	Hollow steel punch - forged steel		9/16"	14mm
MA50552	MAYHEW	Hollow punch - Quality tool steel			4mm
MA50554	MAYHEW	Hollow punch - Quality tool steel			6mm
MA50556	MAYHEW	Hollow punch - Quality tool steel			8mm
MA50558	MAYHEW	Hollow punch - Quality tool steel			10mm
MA50559	MAYHEW	Hollow punch - Quality tool steel			12mm
MA50507	MAYHEW	Hollow punch - Quality tool steel			1/2"
MA50560	MAYHEW	Hollow punch - Quality tool steel			14mm
MA50562	MAYHEW	Hollow punch - Quality tool steel			18mm
MA50510	MAYHEW	Hollow punch - Quality tool steel			3/4"
MA50564	MAYHEW	Hollow punch - Quality tool steel			22mm
MA50512	MAYHEW	Hollow punch - Quality tool steel			1"
MA50567	MAYHEW	Hollow punch - Quality tool steel			28mm
MA50518	MAYHEW	Hollow punch - Quality tool steel			1-3/8"
MA50575	MAYHEW	Hollow punch - Quality tool steel			44mm
MA66016	MAYHEW	36pc Hollow punch set - Quality tool steel			
CHASSIS PUNCHES:				diameter	screw size
RO21832	ROTHEN	ROTHENBERGER chassis punch		32.0mm	
RO21835	ROTHEN	ROTHENBERGER chassis punch		35.0mm	
LETTER and NUMBER PUNCHES:				size	length
DRLPS-06	DRAPER	Letter punch set of 26		6.0mm	60mm



GN1280-14
Hollow punch



MA50572
Hollow punch



MA50518
Hollow punch



GN1271-25
Wad punch



RO21832
32mm Chassis punch



RO21835
35mm Chassis punch



DRLPS-06
Letter punch set



MU1001-05
Hollow punch set



MU1000-05
Hollow punch set

PIN PUNCHES/ DRIFT PUNCHES:
diameter
length

MA42002	MAYHEW	"Select" Parallel pin punch - carded	3/32"	113mm
MA42102	MAYHEW	"Select" Parallel pin punch - carded	1/8"	113mm
MA42202	MAYHEW	"Select" Parallel pin punch - carded	1/8"	150mm
MA42302	MAYHEW	"Select" Parallel pin punch - carded	5/32"	150mm
MA42402	MAYHEW	"Select" Parallel pin punch - carded	3/16"	150mm
MA42702	MAYHEW	"Select" Parallel pin punch - carded	1/4"	150mm
MA21000	MAYHEW	"Pro" Parallel pin punch	1/16"	100mm
MA21001	MAYHEW	"Pro" Parallel pin punch	3/32"	113mm
MA21004	MAYHEW	"Pro" Parallel pin punch	3/16"	131mm
MA62080	MAYHEW	"Pro" Parallel pin punch set of 5	3mm - 8mm	
MA21500	MAYHEW	"Pro" Long parallel pin punch	1/8"	200mm
MA21504	MAYHEW	"Pro" Long parallel pin punch	3/8"	200mm
MA62065	MAYHEW	"Pro" Long parallel pin punch set of 5	1/8" - 3/8"	
MA43902	MAYHEW	"Select" Long taper line-up punch - carded	1/8"	200mm
MA43952	MAYHEW	"Select" Long taper line-up punch - carded	5/32"	225mm
MA44002	MAYHEW	"Select" Long taper line-up punch - carded	3/16"	225mm
MA44102	MAYHEW	"Select" Long taper line-up punch - carded	1/4"	300mm
MA44202	MAYHEW	"Select" Long taper line-up punch - carded	5/16"	300mm
MA22008	MAYHEW	"Pro" Ex-long taper line-up punch	5/16"	400mm
MA22017	MAYHEW	"Pro" Ex-long taper line-up punch	3/8"	375mm
MA22024	MAYHEW	"Pro" Ex-long taper line-up punch	1/2"	300mm
MA25076	MAYHEW	"Pro" Knurled brass drift punch	1/2"	101mm
MA61360	MAYHEW	"Pro" Knurled brass drift punch set - 3 piece	3/8" - 3/4"	
MA89032	MAYHEW	"Select" Small pin punch set - 3 piece	1/16" - 1/8"	
MA89052	MAYHEW	"Select" Long pin punch set - 3 piece	1/8" - 1/4"	
MA62235	MAYHEW	Line-Up Punch Kit - 4 piece	1/4" - 1/2"	

PIN PUNCHES BULK



MA21000

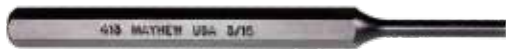

MA21004

BULK LONG TAPERED LINE UP PUNCHES



MA22008



MA22017



MA25076
Knurled brass drift punch

LONG PIN PUNCHES BULK



MA21500

CARDED PIN PUNCHES



MA42102



MA42302



MA42702

CARDED LONG TAPERED LINE UP PUNCHES



MA43902



MA44002



MA44202

PIN PUNCHES SETS



MA61360
Brass drift punch set
3pc



MA89032
Small pin punch
set - 3pc



MA89052
Long pin punch set
3pc



MA62065
Long parallel pin punch set
5pc

NAIL PUNCHES:				diameter	length
ST58-111	STANLEY	Nail set (punch) - Square head		0.8mm	100mm
ST58-112	STANLEY	Nail set (punch) - Square head		1.6mm	100mm
ST58-113	STANLEY	Nail set (punch) - Square head		2.4mm	100mm
ST58-114	STANLEY	Nail set (punch) - Square head		3.2mm	100mm
ST58-230	STANLEY	Nail set (punch) set of 3			100mm
ST58-930	STANLEY	Dynagrip nail set (punch) - set of 3			100mm
MA47502	MAYHEW	"Select" Nail set (punch) set of 3		1/32" 1/16" 3/32"	
DR58-230	DRAPER	Cupped Nail set (punch) set of 4			100mm
CENTRE PUNCHES:				diameter	length
MA23003	MAYHEW	"Pro" Prick punch		1/2"	150mm
MA43502	MAYHEW	"Select" Prick punch - carded		7/32"	125mm
MA74000	MAYHEW	"Select" Centre punch		1/4"	100mm
MA24002	MAYHEW	"Pro" Centre punch		3/16"	125mm
MA24004	MAYHEW	"Pro" Centre punch		3/8"	157mm
MA41202	MAYHEW	"Select" Centre punch - hex body - carded		5/32"	114mm
MA41602	MAYHEW	"Select" Centre punch - hex body - carded		3/8"	125mm
MA41702	MAYHEW	"Select" Centre punch - hex body - carded		1/2"	150mm
FAICP18SH	FAITHFULL	Centre punch - Square head - carded		3.0mm	100mm
SR117C	STARRETT	Centre punch - Round - tapered		1/8"	100mm
SR117D	STARRETT	Centre punch - Round - tapered		5/32"	100mm
SR117E	STARRETT	Centre punch - Round - tapered		1/4"	125mm
GN79	GENERAL	Automatic centre punch			130mm
DRE171	DRAPER	Automatic centre punch			125mm
MA20900	MAYHEW	"PRO" Rivet setting tool		3/8"	125mm
PUNCH AND CHISEL SETS:					
MA61044	MAYHEW	Punch and chisel set of 14 - POUCH		5 parallel pin punches 3 taper punches 1 centre punch 5 cold chisels	
MA89082	MAYHEW	Centre/prick punch set - CARD		5/16" 7/16" centre punch 7/32" prick punch	
MA90402	MAYHEW	Punch and chisel set of 5 - CARD		3mm taper 4mm centre punch 3mm parallel pin punch 13mm 19mm cold chisel	
MA66260	MAYHEW	Punch and chisel set of 12		Cold Chisels: 1x ea 7, 13, 19mm Long pin punch: 1x ea 4, 5, 6, 7, 8, 9mm Centre Punch: 1x ea 5, 8mm Solid Punch: 3mm	



DR58-230
Nail punch set



ST58-230
Nail punch set



ST58-930
Nail punch set



MA47502
Nail punch set



ST58-111
0.8mm Nail punch



ST58-113
2.4mm Nail punch



MA74000
1/4" Centre punch



MA24002
3/16" Centre punch



MA24004
3/8" Centre punch



MA41202
Carded Centre punch



MA41602
Carded Centre punch



MA41702
Carded Centre punch



FAICP18SH
3.0mm Centre punch - Square Head



SR117E
6.5mm Centre punch - Round Head



GN79
Automatic centre punch



MA61044
12pc Punch & Chisel set



MA89082
3pc Centre/Prick punch set



MA90402
5pc Punch & Chisel set



DRE171
Automatic centre punch



MA61044
14pc Punch & Chisel set



MA66260
12pc Punch & Chisel set



MA23003
1/2" Prick punch



MA20900
3/8" Rivet setting punch

57						
BLACK CABLE TIES - UV RESISTANT:				Length	Width	Min. Strength
TWCB425	STANWAY	Cable Ties - pack of 25		100mm	2.5mm	8kg
TWCB4100	STANWAY	Cable Ties - pack of 100		100mm	2.5mm	8kg
TWCB4500	STANWAY	Cable Ties - pack of 500		100mm	2.5mm	8kg
TWCB625	STANWAY	Cable Ties - pack of 25		150mm	3.5mm	18kg
TWCB6100	STANWAY	Cable Ties - pack of 100		150mm	3.5mm	18kg
TWCB6500	STANWAY	Cable Ties - pack of 500		150mm	3.5mm	18kg
TWCB825	STANWAY	Cable Ties - pack of 25		200mm	4.6mm	22kg
TWCB8100	STANWAY	Cable Ties - pack of 100		200mm	4.6mm	22kg
TWCB8500	STANWAY	Cable Ties - pack of 500		200mm	4.6mm	22kg
TWCB1125	STANWAY	Cable Ties - pack of 25		288mm	4.6mm	22kg
TWCB11100	STANWAY	Cable Ties - pack of 100		288mm	4.6mm	22kg
TWCB11500	STANWAY	Cable Ties - pack of 500		288mm	4.6mm	22kg
TWCB1525	STANWAY	Cable Ties - pack of 25		371 mm	4.6mm	22kg
TWCB15100	STANWAY	Cable Ties - pack of 100		371 mm	4.6mm	22kg
TWCB1525HD	STANWAY	Light Heavy Duty Cable Ties - pack of 25		371 mm	7.5mm	54kg
TWCB15100HD	STANWAY	Light Heavy Duty Cable Ties - pack of 100		371 mm	7.5mm	54kg
TWCB18100	STANWAY	Light Heavy Duty Cable Ties - pack of 100		450mm	7.5mm	54kg
TWCB21100HD	STANWAY	Heavy Duty Cable Ties - pack of 100		530mm	8.7mm	80kg
TWCB24100HD	STANWAY	Heavy Duty Cable Ties - pack of 100		610mm	8.7mm	80kg
TWCB37100HD	STANWAY	Heavy Duty Cable Ties - pack of 100		910mm	8.7mm	80kg
TWCB41100HD	STANWAY	Heavy Duty Cable Ties - pack of 100		1160mm	8.7mm	80kg
TWCB49100HD	STANWAY	Heavy Duty Cable Ties - pack of 100		1200mm	8.7mm	80kg
NEUTRAL CABLE TIES - NON UV RESISTANT:				Length	Width	Min. Strength
TWCN425	STANWAY	Cable Ties - pack of 25		100mm	2.5mm	8kg
TWCN4100	STANWAY	Cable Ties - pack of 100		100mm	2.5mm	8kg
TWCN625	STANWAY	Cable Ties - pack of 25		150mm	3.5mm	18kg
TWCN6100	STANWAY	Cable Ties - pack of 100		150mm	3.5mm	18kg
TWCN825	STANWAY	Cable Ties - pack of 25		200mm	4.6mm	22kg
TWCN15100HD	STANWAY	Light Heavy Duty Cable Ties - pack of 100		371 mm	7.5mm	54kg



TWCB4100
UV BLACK
100mm x 2.5mm



TWCB6100
UV BLACK
150mm x 3.5mm



TWCB8100
UV BLACK
200mm x 4.6mm



TWCB11100
UV BLACK
288mm x 4.6mm



TWCB15100
UV BLACK
370mm x 4.6mm



TWCB18100
UV BLACK
450mm x 7.5mm



TWCN4100
NEUTRAL
100mm x 2.5mm



TWCN6100
NEUTRAL
150mm x 3.5mm



TWCN15100HD
NEUTRAL
370mm x 7.5mm



TWCB15100HD
UV BLACK
370mm x 7.5mm



TWCB
Cable ties



TWCN
Cable ties



TWCB HD
Cable ties



TWCN HD
Cable ties

SAFETY GLOVES:
Size

EST7790M	ESTWING	Synthetic Leather Palm Glove	M
EST7990M	ESTWING	Split Cowhide Leather Palm Glove	M
EST7990L	ESTWING	Split Cowhide Leather Palm Glove	L
EST7990XL	ESTWING	Split Cowhide Leather Palm Glove	XL
RO72120	ROTHENBERGER	Leather studded Spiral guide gloves	Left Hand
RO72121	ROTHENBERGER	Leather studded Spiral guide gloves	Right Hand

BARRIER TAPES:
size

TWCT0300	STANWAY	Barrier safety tape - "CAUTION"	Yellow	90m/300ft
TWCT1000	STANWAY	Barrier safety tape - "CAUTION"	Yellow	300m/1000ft
TWDT0300	STANWAY	Barrier safety tape - "DANGER"	Red	90m/300ft
TWDT1000	STANWAY	Barrier safety tape - "DANGER"	Red	300m/1000ft
HNBST-ELECTRIC	STANWAY	Detectable tape "CAUTION: BURIED ELECTRIC LINE"	Red	300m/1000ft
HNBST-GAS	STANWAY	Detectable tape "CAUTION GAS LINE BURIED"	Yellow	300m/1000ft
HNBST-SEWER	STANWAY	Detectable tape "CAUTION: BURIED SEWER"	green	300m/1000ft
HNBST-WATER	STANWAY	Detectable tape "WATER LINE BURIED"	Blue	300m/1000ft

KNEE PADS/KNEELER BOARD:

MTGKP37	MARSHTOWN	Professional gel knee pads
MT451	MARSHTOWN	Kneeler board - double handled

SAFETY GOGGLES/EAR MUFFS:

PG505-40	PG	Ear protectors - Professional grade - Class 5	30dB protection
----------	----	---	-----------------



TWDT0300
Danger barrier tape



TWDT1000
Danger barrier tape



TWCT0300
Caution barrier tape



TWCT1000
Caution barrier tape



HNBST-ELECTRIC
Detectable tape
"Caution: Buried Electric
line Below"



HNBST-GAS
Detectable tape
Caution: Buried Gas
Line Below"



HNBST-SEWER
detectable tape
"Caution: Buried Sewer
Line Below"



HNBST-WATER
Detectable barrier tape
"Caution: Buried Water
Line Below"



EST7790
Synthetic leather palm glove



EST7990
Split cowhide leather palm glove



RO72120
Leather guide glove LH



RO72121
Leather guide glove RH



MT451
Kneeler board



MTGKP37
Pro-Gel knee pads



PG505-40
Pro ear protectors

59					
WOODEN SHOVELS & SPADES:				Mouth Size	Handle Length
TW4210	STANWAY	Square Mouth Spade with D-Handle		250 x 300mm	736mm
TW4120	STANWAY	Square Mouth Shovel with Long Handle		265 x 315mm	1320mm
TW4110	STANWAY	Square Mouth Shovel with D-Handle		265 x 315mm	736mm
DRMSRP700	DRAPER	Round Point Mini Shovel with YD-Handle		150 x 200mm	500mm
TW4410	STANWAY	Plumbers Shovel with Long Handle		190 x 285mm	1320mm
TW4020	STANWAY	Round Mouth Shovel with Long Handle		265 x 300mm	1320mm
TW4310	STANWAY	Post Hole Spade with Long Handle		190 x 275mm	1320mm
TW4510	STANWAY	Trenching Shovel with Long Handle		105 x 310mm	1320mm
FIBREGLASS SHOVELS & SPADES:				Mouth Size	Handle Length
TW7210	STANWAY	Square Mouth Spade with Long Handle		250 x 300mm	1320mm
TW7120	STANWAY	Square Mouth Shovel with Long Handle		265 x 315mm	1320mm
TW7110	STANWAY	Square Mouth Shovel with D-Handle		265 x 315mm	736mm
TW7410	STANWAY	Plumbers Shovel with Long Handle		190 x 285mm	1320mm
AS00600	ATLAS	Round Mouth Shovel with Long Handle		255 x 315mm	1180mm
TW7010	STANWAY	Round Mouth Shovel with D-Handle		265 x 300mm	736mm
TW7020	STANWAY	Round Mouth Shovel with Long Handle		290 x 325mm	1320mm
TW7310	STANWAY	Post Hole Shovel with Long Handle		190 x 275mm	1320mm
TW7510	STANWAY	Trenching Shovel with Long Handle		105 x 310mm	1320mm
AS00638	ATLAS	Trenching Spade with D-Handle		170 x 395mm	740mm
AS00612	ATLAS	Trenching Shovel with Long Handle		180 x 301mm	1180mm
INSULATED SHOVELS & SPADES:				Mouth Size	Handle Length
DRDRAIN-INS	DRAPER	Drainage Shovel with Insulated YD-Handle		180 x 400mm	720mm
DRTAPER-INS	DRAPER	Taper Mouth Shovel with Insulated YD-Handle		245 x 315mm	720mm
ALL STEEL SHOVELS, SPADES & TOOLS:				Mouth Size	Handle Length
DRSQMOUTH-AS	DRAPER	Square Mouth Spade with YD-Handle		185 x 290mm	750mm
DRDRAIN-AS	DRAPER	Drainage Shovel with YD-Handle		180 x 405mm	750mm
TW5000	STANWAY	Post Hole Digger		138 x 370mm	1500mm
REPLACEMENT HANDLES:				Length	
TW4900	STANWAY	Long Wooden Shovel Handle			1320mm
TW4910	STANWAY	Wooden Shovel D-Handle			736mm
TW7900	STANWAY	Long Fibreglass Shovel Handle			1320mm
TW7910	STANWAY	Fibreglass Shovel D-Handle			736mm
RV2024	RAVEN	Wooden Broom Handle			1350mm
MANHOLE LIFTERS/PROBING SPEAR:				Diameter	Length
TW8000	STANWAY	Probing Spear		10mm	1180mm
TW8600	STANWAY	T-Style Manhole Lifter		30mm Key	622mm
TW8800	STANWAY	Heavy Duty Folding Manhole Lifter		30mm Key	470 - 795mm
TWX8800-TEND	STANWAY	Replacement T-end Hinge Arm for TW8800			
TWX8800-MB	STANWAY	Replacement Main Body for TW8800			
RAKES, BRUSHES AND BROOMS:				Mouth Size	Handle Length
TW4610	STANWAY	Contractors Rake with Long Hickory Handle		410 x 75mm	1320mm
RV8128	RAVEN	Yard Broom (Hi-Vis Still Fill)		355 x 80mm	1350mm
RV8122	RAVEN	Platform Broom (Java-Tech Fill)		610 x 65mm	1350mm
RV8017	RAVEN	King Gong Scrub Brush			

WOODEN HANDLE



TW4210 TW4120 TW4110 DRMSRP700 TW4410 TW4020 TW4310 TW4510

INSULATED HANDLE



DRDRAIN-INS DRTAPER-INS

FIBREGLASS HANDLE



TW7210 TW7120 TW7110 TW7410 AS00600 TW7010 TW7020 TW7310 TW7510 AS00638 AS00612

ALL STEEL



DRSQMOUTH-AS DRDRAIN-AS TW5000

REPLACEMENT HANDLES



TW4900 TW4910 TW7900 TW7910 RV2024

RAKES / BROOMS / BRUSH



TW4610 RV8128 RV8122

PROBING SPEARS / MANHOLE LIFTERS

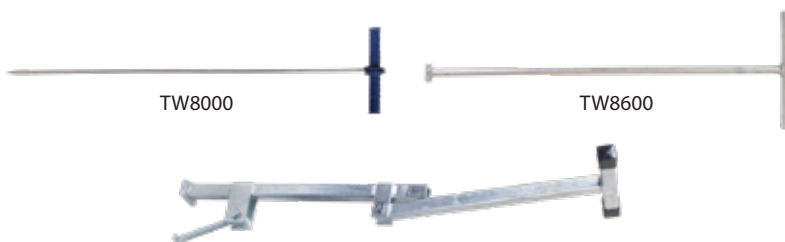

TW8000 TW8600

TW8800



RV8017

STANWAY INDUSTRIAL SCREWDRIVER BITS - CARDED
Shank
Size
Length
PHILLIPS BITS

TWCP04	STANWAY	Phillips drive bit - Carded	1/4" Hex	No.1	50mm
TWCP05	STANWAY	Phillips drive bit - Carded	1/4" Hex	No.2	50mm

SQUARE RECESS BITS

TWCP97	STANWAY	Square recess bit	1/4" Hex	No.1	50mm
TWCP98	STANWAY	Square recess bit	1/4" Hex	No.2	50mm
TWCP126	STANWAY	Square recess bit	1/4" Hex	No.2	100mm
TWCP134	STANWAY	Square recess bit	1/4" Hex	No.3	50mm

POZIDRIV BITS

TWCP12	STANWAY	Pozidrive bit	1/4" Hex	No.1	50mm
TWCP153	STANWAY	Pozidrive bit	1/4" Hex	No.2	150mm

SLOTTED BITS

TWCP23	STANWAY	Slotted bit	1/4" Hex	8mm	50mm
--------	---------	-------------	----------	-----	------

MAGNETIC NUTSETTERS

TWCP30	STANWAY	Magnetic nutsetter	1/4" Hex	5/16"	65mm
TWCP31	STANWAY	Magnetic nutsetter	1/4" Hex	3/8"	65mm

STANWAY INDUSTRIAL SCREWDRIVER BIT SETS
Shank
Length

TWCP159	STANWAY	10pc Assorted screwdriver bit set - Carded <i>Square Bits: No.1, No.2, No.3</i> <i>Pozidrive Bits: No.1, No.2</i> <i>Phillips Bits: No.1, No.2, No.3</i> <i>Slotted Bit: 8mm</i> <i>Hex Bit: 5mm</i>	1/4" Hex		50mm
TWCP160	STANWAY	10pc Assorted screwdriver bit set - Carded <i>Square Bits: No.1, No.2, No.3</i> <i>Pozidrive Bits: No.1, No.2</i> <i>Phillips Bits: No.1, No.2, No.3</i> <i>Slotted Bit: 8mm</i> <i>Hex Bit: 5mm</i>	1/4" Hex		100mm



TWCP04
Ph #1 x 50mm



TWCP05
Ph #2 x 50mm



TWCP23
SL 8mm x 50mm



TWCP12
Pz #1 x 50mm



TWCP153
Pz #2 x 150mm



TWCP30
Nut setter
5/16 x 65mm



TWCP31
Nut setter
3/8 x 65mm



TWCP97
Sq #1 x 50mm



TWCP98
Sq #2 x 50mm



TWCP126
Sq #2 x 100mm



TWCP159
10pc x 50mm
Assorted bit set



TWCP160
10pc x 100mm
Assorted bit set

61			
POZI SCREWDRIVER BITS - CARDED:			length
GFB10	GFB	No 1 pozidrive - 2 pack	25mm
GFB12	GFB	No 1 pozidrive	50mm
GFB11	GFB	No 2 pozidrive - 2 pack	25mm
GFB13	GFB	No 2 pozidrive	50mm
GFB152	GFB	No 2 pozidrive	65mm
GFB136	GFB	No 2 pozidrive	75mm
GFB149	GFB	No 2 pozidrive	100mm
GFB153	GFB	No 2 pozidrive	150mm
GFB14	GFB	No 3 pozidrive	50mm
SQUARE SCREWDRIVER BITS - CARDED:			length
GFB95	GFB	No 1 square recess - 2 pack	25mm
GFB97	GFB	No 1 square recess	50mm
GFB125	GFB	No 1 square recess	100mm
GFB96	GFB	No 2 square recess - 2 pack	25mm
GFB98	GFB	No 2 square recess	50mm
GFB126	GFB	No 2 square recess	100mm
GFB197	GFB	No 2 square recess	150mm
GFB122	GFB	No 2 square recess double end - 2 pack	45mm
GFB124	GFB	No 2 square recess double end - 2 pack	65mm
GFB174	GFB	No 2 SQ x No 1 SQ double end - 2 pack	50mm
GFB128	GFB	No 3 square recess - 2 pack	25mm
GFB134	GFB	No 3 square recess	50mm
DOUBLE END SQ/PZ SCREWDRIVER BITS - CARDED:			length
GFB201	GFB	No 2 square x No 2 pozidrive - 2 pack	65mm
TORX SCREWDRIVER BITS:			length
GFB-285B	GFB	T-10 Torx tamper proof (Bulk)	75mm
GFB-286B	GFB	T-15 Torx tamper proof (Bulk)	75mm
GFB141	GFB	T-20 Torx tamper proof	25mm
GFB287	GFB	T-20 Torx tamper proof	75mm
GFB142	GFB	T-25 Torx tamper proof	25mm
GFB520	GFB	T-25 Torx tamper proof	50mm
GFB535	GFB	T-10 Torx - NON tamper proof	50mm
GFB536	GFB	T-15 Torx - NON tamper proof	50mm
GFB514	GFB	T-20 Torx - NON tamper proof	50mm
GFB529	GFB	T-20 Torx - NON tamper proof	150mm
GFB515	GFB	T-25 Torx - NON tamper proof	50mm
GFB530	GFB	T-25 Torx - NON tamper proof	150mm
GFB516	GFB	T-30 Torx - NON tamper proof	50mm
GFB531	GFB	T-30 Torx - NON tamper proof	150mm
GFB528	GFB	T-40 Torx - NON tamper proof	50mm
GFB518	GFB	T-50 Torx - NON tamper proof	50mm
HEX HEAD SCREWDRIVER BITS - CARDED:			length
GFB350	GFB	4mm hex-head bit	50mm
GFB24	GFB	5mm hex-head bit	32mm
GFB120	GFB	5mm hex-head bit	50mm
GFB428	GFB	5mm hex-head bit	100mm
GFB411	GFB	6mm hex-head bit	50mm
SOCKET ADAPTOR BITS - CARDED:			length
GFB40	GFB	1/4" square socket adaptor	50mm
GFB39	GFB	3/8" square socket adaptor	75mm
GFB315	GFB	1/2" square socket adaptor	75mm
MAGNETIC BIT HOLDERS/ADAPTORS - CARDED:			length
GFB25	GFB	Magnetic insert bit holder	75mm
GFB402	GFB	Bit holder with flexible extension	200mm
GFB348	GFB	Universal magnetic bit holder	150mm x 12.0mm
GFB456	GFB	Universal magnetic bit holder	200mm x 12.0mm
GFB397	GFB	Off-line driver bit holder	100mm
GFB398	GFB	1/2" Square Drive to 1/4" Hex Drive Adaptor	
GFB490	GFB	Right angle flexible driver	300mm
GFB543	GFB	Coloured Driver Tool Bit Catcher Set - Suits 1/4" Hex	4pc
GFB544	GFB	Coloured Driver Tool Bit Catcher - Suits 1/4" Hex	1pc



GFB25
Mag. insert bit holder



GFB397
Off-Line driver bit holder



GFB402
Flexible extension bit holder



GFB39
75mm x10mm socket adaptor



GFB456
Universal magnetic bit holder



GFB490
Right angle driver flexible



GFB142
25mm T-25 Torx



GFB516
50mm T-30 Torx



GFB287
75mm T-20 Torx
Tamper proof



GFB398
Fem. Sq Dr Bit with circlip
1/2"



GFB544
1/4" Driver Tool
Bit Catcher



GFB543
1/4" Driver Tool
Bit Catcher Set



GFB153
150mm No 2 Poz



GFB11
25mm No 2 Poz



GFB96
25mm No 2 Square



GFB98
50mm No 2 Square



GFB197
150mm No 2 Square



GFB120
50mm 5mm
hex-head

PHILLIPS SCREWDRIVER BITS – CARDED:
length

GFB04	GFB	No 1 phillips	50mm
GFB02	GFB	No 2 phillips – 2 pack	25mm
GFB05	GFB	No 2 phillips	50mm
GFB45	GFB	No 2 phillips	65mm
GFB07	GFB	No 2 phillips	75mm
GFB35	GFB	No 2 phillips	100mm
GFB36	GFB	No 2 phillips	150mm
GFB09	GFB	No 2 phillips double end – 2 pack	65mm
GFB06	GFB	No 3 phillips	50mm

SLOTTED SCREWDRIVER BITS – CARDED:
length

GFB19	GFB	3mm slotted	50mm
GFB21	GFB	5mm slotted	50mm
GFB22	GFB	6mm slotted	50mm
GFB23	GFB	8mm slotted	50mm
GFB147	GFB	10mm slotted	50mm

MAGNETIC NUT SETTERS – CARDED:

GFB26	GFB	1/4" magnetic nut setter	42mm
GFB27	GFB	5/16" magnetic nut setter	42mm
GFB28	GFB	3/8" magnetic nut setter	42mm
GFB29	GFB	1/4" magnetic nut setter	69mm
GFB30	GFB	5/16" magnetic nut setter	69mm
GFB31	GFB	3/8" magnetic nut setter	69mm
GFB353	GFB	7/16" magnetic nut setter	65mm
GFB206	GFB	5/16" magnetic nut setter – long	150mm
GFB420	GFB	3/8" magnetic nut setter – long	150mm
GFB74	GFB	10mm magnetic nut setter	45mm



GFB09
Ph #2 Dbl End
65mm



GFB02
Phillips #2
25mm



GFB05
Phillips #2
50mm



GFB45
Phillips #2
65mm



GFB07
Phillips #2
75mm



GFB35
Phillips #2
100mm



GFB36
Phillips #2
150mm



GFB19
Slotted 3mm
50mm



GFB21
Slotted 5mm
50mm



GFB22
Slotted 6mm
50mm



GFB147
Slotted 10mm
50mm



GFB206
Mag. Nutsetter
5/16" x 150mm



GFB420
Mag. Nutsetter
3/8" x 150mm



GFB74
Mag. Nutsetter
10mm x 45mm



GFB26
Mag. Nutsetter
1/4" x 45mm



GFB27
Mag. Nutsetter
5/16" x 45mm



GFB28
Mag. Nutsetter
3/8" x 45mm



GFB29
Mag. Nutsetter
1/4" x 69mm



GFB30
Mag. Nutsetter
5/16" x 69mm



GFB31
Mag. Nutsetter
3/8" x 69mm



GFB353
Mag. Nutsetter
7/16" x 65mm

63

IMPACT RATED POZIDRIVE BITS – BULK PACKED:
length

GFB-13B

GFB

No 2 pozidrive

50mm

IMPACT RATED PHILLIPS BITS – BULK PACKED:
length

GFB-05B

GFB

No 2 phillips

50mm

IMPACT RATED HEX BITS – BULK PACKED:
length

GFB-120B

GFB

5mm hex-head

50mm

AUTO-FEED ACCESSORIES AND SPARES:

TW-QDX2PH

STANWAY

No 2 Phillips drive bit

TW-QDX2SQ

STANWAY

No 2 Square drive bit

TW-QDX2USQ

STANWAY

No 2 Square under size drive bit

TW-QDX3SQ

STANWAY

No 3 Square drive bit

TW-QDX3USQ

STANWAY

No 3 Square under size drive bit



GFB-13B
50mm No 2 Pozidrive



GFB-05B
50mm No 2 Phillips



GFB-120B
50mm 5mm Hex-head



TW-QDX3USQ
No 3 Square under size drive bit



TW-QDX3SQ
No 3 Square drive bit



TW-QDX2SQ
No 2 Square drive bit



TW-QDX2USQ
No 2 Square under size drive bit



TW-QDX2PH
No 2 Phillips drive bit

IMPACT RATED SQUARE DRIVE BITS - BULK PACKED:
length

GFB-96B	GFB	No 2 square	25mm
GFB-133B	GFB	No 0 square	50mm
GFB-97B	GFB	No 1 square	50mm
GFB-98B	GFB	No 2 square	50mm
GFB-125B	GFB	No 1 square	100mm
GFB-126B	GFB	No 2 square	100mm
GFB-197B	GFB	No 2 square	150mm

IMPACT RATED MAGNETIC NUT SETTERS - BULK PACKED:

GFB-27B	GFB	5/16" magnetic nut setter	42mm
GFB-28B	GFB	3/8" magnetic nut setter	42mm
GFB-30B	GFB	5/16" magnetic nut setter	69mm
GFB-31B	GFB	3/8" magnetic nut setter	69mm
GFB-206B	GFB	5/16" magnetic nut setter	150mm
GFB-208B	GFB	5/16" magnetic nut setter	200mm



GFB-96B
25mm #2 SQ



GFB-98B
50mm #2 SQ



GFB-126B
100mm #2 SQ



GFB-197B
150mm #2 SQ



GFB-27B
42mm 5/16" Magnetic nut setter



GFB-30B
69mm 5/16" Magnetic nutsetter



GFB-206B
150mm 5/16" Magnetic nutsetter



GFB-208B
200mm 5/16" Magnetic nutsetter

65		INDUSTRIAL SCREWDRIVER BIT SETS:		pack size	length
GFB395C	GFB	Assorted screwdriver bit set contains: PH: 1, 2 SQ: 1, 2 HEX: 5mm PZ: 1, 2 TORX: T20, T25, T30 1x 5mm x 7mm slotted bit 1 x 5/16", 1 x 1/4", 1x3/8" 1x 10mm nut setter	15pc	100mm 50mm 65mm 69mm	
GFB396C	GFB	Assorted screwdriver bit set contains: 1x ea PZ: 1 & 2, 1 x ea PH: 1, 2 & 3, 1x ea SQ: 1 & 2 1x hex 5mm, 1x TX T20, 1x SL 6mm 1x ea nutsetters: 1/4", 5/16", 3/8" 1x ea socket adaptor: 1/4", 3/8", 1/2" 1x bit holder: 1*/4"	17pc	50mm 42mm	
GFB370	GFB	Assorted screwdriver bit set contains: 1x ea PH 1, 2 & 3, PZ 1 & 2, SQ 1 & 2, Hex 5mm SL 6mm, TX 20	10pc	50mm	
GFB422	GFB	No 2 Square screwdriver bit set	5 pk	50mm	
GFB423	GFB	No 2 Square screwdriver bit set	10 pk	50mm	
GFB424	GFB	5mm Hex screwdriver bit set	5 pk	50mm	
GFB408	GFB	No 2 Philips bit set	15 pk	50mm	
GFB409	GFB	5mm Hex bit set	15 pk	50mm	
GFB508	GFB	No .2 Square bit set	15 pk	50mm	
GFB509	GFB	T-20 Torx bit set	15 pk	50mm	
TWCP159	STANWAY	Screwdriver bit set of 10 - carded No 1, No 2, No 3 phillips No 1, No 2 pozidrive No 1, No 2, No 3 square 5mm hex 8mm slotted		50mm	
TWCP160	STANWAY	Screwdriver bit set of 10 - carded No 1, No 2, No 3 phillips No 1, No 2 pozidrive No 1, No 2, No 3 square 4mm, 8mm slotted		100mm	
GFB117	GFB	Dry wall screw holder - includes No 2 Phillips bit 25mm			
GFB316	GFB	Socket Adaptor Set - includes 1/4", 3/8", 1/2" bits	3 pk	75mm	
DRCMBH60	DRAPER	Assorted Coloured Screwdriver Bit Set	60pc	25mm/50mm	
DRMBH80	DRAPER	Screwdriver and Bit Holder Set	80pc	25mm/50mm	
DRISS-10	DRAPER	Impact screwdriver set - 1/2" DR 1/2"DR x 8.0mm adaptor 4 x plain slot bits - 6x36mm, 8x36mm, 8x80mm, 9.5x80mm 4 x PH bits - No.2x36mm, No.3x36mm, No.2x80mm, No.3x80mm	Carded	75mm 10pc	
DRISBS-10	DRAPER	Assorted impact screwdriver bit set - 10 piece SL5, PH2, PH3, PZ1, PZ2(3), PZ3, T20, T25	Carded	50mm	
DRISBS-T20	DRAPER	T20 impact screwdriver bit set of 5	Carded	50mm	
DRISBS-T25	DRAPER	T25 impact screwdriver bit set of 6	Carded	50mm	
DRISBS-T30	DRAPER	T30 impact screwdriver bit set of 7	Carded	50mm	
GFB390	GFB	Magnetic Nutsetter Set - Imperial 1/4", 3/8", 5/16"	3 pk	45mm	
GFB505	GFB	Magnetic Nutsetter Set - Metric 6mm, 8mm, 10mm	3 pk	45mm	
SNAPPY QUICK CHUCK SYSTEM:			screw gauge	size	
SQC40011	SNAPPY	Quick click chuck			
SQC42004	SNAPPY	Drill adaptor - collet nut security - no drill bit		1/16"	
SQC42005	SNAPPY	Drill adaptor - collet nut security - no drill bit		5/64"	
SQC42006	SNAPPY	Drill adaptor - collet nut security - no drill bit		3/32"	
SQC42007	SNAPPY	Drill adaptor - collet nut security - no drill bit		7/64"	
SQC42008	SNAPPY	Drill adaptor - collet nut security - no drill bit		1/8"	
SQC42009	SNAPPY	Drill adaptor - collet nut security - no drill bit		9/64"	
SQC42010	SNAPPY	Drill adaptor - collet nut security - no drill bit		5-32"	
SQC42011	SNAPPY	Drill adaptor - collet nut security - no drill bit		11/64"	
SQC42012	SNAPPY	Drill adaptor - collet nut security - no drill bit		3/16"	
SQC42013	SNAPPY	Drill adaptor - collet nut security - no drill bit		13/64"	
SQC42014	SNAPPY	Drill adaptor - collet nut security - no drill bit		7/32"	
SQC42015	SNAPPY	Drill adaptor - collet nut security - no drill bit		15/64"	
SQC42016	SNAPPY	Drill adaptor - collet nut security - no drill bit		1/4"	
SQC49105	SNAPPY	Self centering hinge drill bit	No 2 - No 4	5/64"	
SQC49107	SNAPPY	Self centering hinge drill bit	No 6 - No 8	7/64"	
SQC49109	SNAPPY	Self centering hinge drill bit	No 8 - No 10	9/64"	
SQC45105	SNAPPY	Replacement HSS Drill for Self centering hinge drill bit	No 2 - No 4	5/64"	
SQC45107	SNAPPY	Replacement HSS Drill for Self centering hinge drill bit	No 6 - No 8	7/64"	
SQC45109	SNAPPY	Replacement HSS Drill for Self centering hinge drill bit	No 8 - No 10	9/64"	



TWCP160
Magnetic bit set
100mm



TWCP159
Magnetic bit set
50mm



GFB422
No 2 Square bit set



GFB424
5mm Hex bit set



GFB316
Socket adapter set



GFB423
No 2 Square bit set



GFB408
Philips #2 15pk



GFB409
Hex 5mm 15pk



GFB508
Square #2 15pk



GFB509
Torx T-20 15pk



GFB117
Drywall screwdriver



SQC40011
Quick click chuck



DRISBS-T20
T20 x 50mm screwdriver bit
5 PACK



DRISBS-10
Assorted screwdriver bit set



SQC45105
5/64" hinge drill bit



SQC42004
Drill adaptor



SQC45107
7/64" hinge drill bit



SQC42008
Drill adaptor



DRISBS-T25
T25 x 50mm screwdriver bit
5 PACK



DRISBS-T30
T30 x 50mm screwdriver bit
5 PACK



SQC45109
9/64" hinge drill bit



SQC42016
Drill adaptor



DRCMBH60
Screwdriver bit set



DRMBH80
Screwdriver bit set



GFB370
Screwdriver bit set



GFB395C
Screwdriver bit set



GFB396C
Screwdriver bit set



DRISS-10
Impact Screwdriver bit set

BATTERIES - ALL TYPES:
Pack size:

PS-AKAAA2V2	PANASONIC	Alkaline battery pack - AAA	2 pack
PS-AKAAA4V2	PANASONIC	Alkaline battery pack - AAA	4 pack
PS-AKAAA8	PANASONIC	Alkaline battery pack - AAA	8 pack
PS-AKAA2V2	PANASONIC	Alkaline battery pack - AA	2 pack
PS-AKAA4V2	PANASONIC	Alkaline battery pack - AA	4 pack
PS-AKAA8	PANASONIC	Alkaline battery pack - AA	8 pack
PS-AKAA12	PANASONIC	Alkaline battery pack - AA	12 pack
PS-AKAA18	PANASONIC	Alkaline battery pack - AA	18 pack
PS-AKC2	PANASONIC	Alkaline battery pack - C type	2 pack
PS-AKD2	PANASONIC	Alkaline battery pack - C type	2 pack
PS-AK9V1	PANASONIC	Alkaline battery pack - 9V	1 pack
PS-AK9V2	PANASONIC	Alkaline battery pack - 9V	2 pack
PS-CR2032-2	PANASONIC	3v Lithium cell battery	2 pack
PS-CR123A	PANASONIC	3v Photo lithium camera battery	1 pack
PS-LR44-2	PANASONIC	Micro Alkaline calculator battery	2 pack
PS-BK3MCCE	PANASONIC	Rechargeable eneloop AA battery	4 pack
PS-BK4MCCE	PANASONIC	Rechargeable eneloop AAA battery	4 pack
PS-KJ51MCC4TA	PANASONIC	Eneloop charger with 4 x Eneloop AA batteries	

TORCHES AND LAMPS
BATTERY

COAHP7	COAST	LED Long range flash light - 360 lumens	AAA (4x)
COAHP7R	COAST	LED Rechargeable long range flashlight - 300 lumens	Li-ion or AAA x4
COAHP14	COAST	LED Long range flash light - 629 lumens	AA (4x)

HOBBY TOOLS/ENGRAVERS:

GN505	GENERAL	Cordless precision engraver	2 x AAA batteries included
GNX505B	GENERAL	Replacement engraver tip for GN505	



PS-AK9V series
Alkaline 9V
Battery



PS-AKAAA series
Alkaline AAA
Battery



PS-AKAA series
Alkaline AA
Battery



PS-AKC series
Alkaline C
Battery



PS-AKD series
Alkaline D
Battery

Packaging Examples



PS-CR2032 series
Lithium 3V
Coin Battery



PS-LR44 series
Alkaline 1.5V
Button Battery



PS-CR123A
Lithium 3V
Camera Battery



PS-BK4MCE
Rechargeable
Battery AAA



PS-BK3MCE
Rechargeable
Battery AA



PS-KJ51MCC4TA
Eneloop Charger with
AA Battery 4pk



GN505
Cordless precision engraver



GNX505B
Replacement engraver tip



COAHP7R
LED Rechargeable long
range flashlight
300 lumens



COAHP7
LED Long range flash light
360 lumens



COAHP14
LED Long range flash light
629 lumens

SLOTTED SCREWDRIVERS:				blade length	tip size
DR349-038065	DRAPER	Flared tip - Ergonomic softgrip screwdriver		38mm	6.5mm
DR349-075030	DRAPER	Parallel tip - Ergonomic softgrip screwdriver		75mm	3.0mm
DR349-100055	DRAPER	Parallel tip - Ergonomic softgrip screwdriver		100mm	5.5mm
DR349-100065	DRAPER	Flared tip - Ergonomic softgrip screwdriver		100mm	6.5mm
DR349-150055	DRAPER	Parallel tip - Ergonomic softgrip screwdriver		150mm	5.5mm
DR349-200080	DRAPER	Flared tip - Ergo softgrip screwdriver pound thru		200mm	8.0mm
DR349-250100	DRAPER	Flared tip - Ergo softgrip screwdriver pound thru		250mm	10.0mm
ST65-563	STANLEY	Flared tip - Square Shank - chrome vanadium blade		300mm	12.0mm
PHILLIPS SCREWDRIVERS:				blade length	tip size
DR350-0	DRAPER	No 0 Phillips - Ergonomic softgrip screwdriver		75mm	Ph #0
DR350-1	DRAPER	No 1 Phillips - Ergonomic softgrip screwdriver		75mm	Ph #1
DR350-2	DRAPER	No 2 Phillips - Ergonomic softgrip screwdriver		100mm	Ph #2
ST65-524	STANLEY	No 2 Phillips - chrome vanadium blade		150mm	Ph #2
DR350-2150	DRAPER	No 2 Phillips - Ergonomic softgrip screwdriver		150mm	Ph #2
DR350-3	DRAPER	No 3 Phillips - Ergonomic softgrip screwdriver		150mm	Ph #3
TORX SCREWDRIVERS:				blade length	tip size
DR350-TX15		Torx - Ergonomic softgrip screwdriver		100mm	T15
DR350-TX20	DRAPER	Torx - Ergonomic softgrip screwdriver		100mm	T20
DR350-TX25	DRAPER	Torx - Ergonomic softgrip screwdriver		100mm	T25
SQUARE SCREWDRIVERS:				blade length	tip size
DR351-1	DRAPER	No 1 Square - Ergonomic softgrip screwdriver		100mm	Sq #1
DR351-2	DRAPER	No 2 Square - Ergonomic softgrip screwdriver		100mm	Sq #2
DR351-3	DRAPER	No 3 Square - Ergonomic softgrip screwdriver		100mm	Sq #3
POZIDRIV SCREWDRIVERS:				blade length	tip size
DR352-1	DRAPER	No 1 Pozi - Ergonomic softgrip screwdriver		75mm	Pz #1
DR352-2	DRAPER	No 2 Pozi - Ergonomic softgrip screwdriver		100mm	Pz #2
DR352-3	DRAPER	No 3 Pozi - Ergonomic softgrip screwdriver		150mm	Pz #3
VDE/1000v INSULATED SCREWDRIVERS				blade length	tip size
WI00847	WIHA	No 1 Phillips - VDE SCREWDRIVER		80mm	PH #1
WI00848	WIHA	No 2 Phillips - VDE SCREWDRIVER		100mm	PH #2
DR644-2	DRAPER	No 2 Pozi / Slot - VDE 1000v insulated		100mm	Pz #2 / Slot



DR350-0
75mm #0 PH



DR350-1
75mm #1 PH



DR350-2
100mm #2 PH



DR350-2150
150mm #2 PH



DR350-3
150mm #3 PH



DR351-1
100mm x #1 SQ



DR351-2
100mm x #2 SQ



DR351-3
100mm x #3 SQ



DR352-1
75mm #1 PZ



DR352-2
100mm #2 PZ



DR352-3
150mm #3 PZ



DR349-038065
38mm x 6.5 flared tip



DR349-075030
75mm x 3.0 parallel tip



DR349-100055
100mm x 5.5 parallel tip



DR349-100065
100mm x 6.5 flared tip



DR349-150055
150mm x 5.5 parallel tip



DR349-200080
200mm x 8.0 flared tip



DR349-250100
250mm x 10.0 flared tip



DR350-TX15
T15 x 100mm



DR350-TX20
T20 x 100mm



DR350-TX25
T25 x 100mm



ST65-524
150mm #2 PH



ST65-563
300mm x 12.0 Mechanics



WI00848
VDE PH2 x 100mm



DR644-2
100mm #2 PZ / Slot VDE

MAINS AND CIRCUIT TESTING SCREWDRIVERS:				For Voltage	size
DRMVT140	DRAPER	Mains testing screwdriver - 100-250v		100 - 250v	140mm
DRMVT190	DRAPER	Mains testing screwdriver - 100-250v		101 - 250v	190mm
DRNCV600	DRAPER	Non contact voltage tester - 100v - 600v		2x AAA batteries included	
TW-UTC15	UNI-T	Digital voltage tester - IP65 rating		0 - 690V	180mm
RATCHET SCREWDRIVERS:					size
GN807X	GENERAL	Ratchet offset screwdriver - No 1 x No 2 phillips			100mm
GN807SX	GENERAL	Ratchet offset screwdriver - No 2 phillips x 6mm slotted			100mm



DRMVT140
Mains testing screwdriver 100-250V



DRMVT190
Mains testing screwdriver 100-250V



DRNCV600
Non Contact Voltage Tester 100-600V



TW-UTC15
Digital voltage tester



GN807X
Ratchet offset No 1 x No 2 Phillips



GN807SX
Ratchet offset No 2 Phillips x 6mm slotted

69				
SCREWDRIVER SETS:				
ST65-750	STANLEY	Screwdriver set - Phillips and slotted in carry case Contains: 6.0 x 38mm, 3.0 x 45mm, 4.0 x 75mm, 5.0 x 100mm, 6.0 x 150mm, 8.0 x 200mm, 10.0 x 250mm PH #1 x 38mm, PH #0 x 60mm, PH #1 x 100mm, PH #2 x 150mm, PH #3 x 150mm, PH #2 x 200mm VDE: 5.0 x 150mm		14pc
ST65-005	STANLEY	Screwdriver set - Phillips and slotted in carry case Contains: 75 x 3.0mm, 100x 5.0mm, 150 x 6.5mm, 150 x 8.0mm, 45 x 6.5mm PH0 x 60mm, PH1 x 100mm, PH2 x 45mm, PH2 x 100mm, PH3 x 150mm		10pc
DRSDSET10	DRAPER	Ergo grip screwdriver set in plastic molded case Contains: SQ1 x 100mm, SQ2 x 100mm PH1 x 75mm, PH2 x 100mm, PH2 x 38mm PZ1 x 75mm, PZ2 x 100mm SLOT 3mm x 75mm, 5mm x 100mm, 6mm x 100mm		10pc
FT108-0016	FULLER	Ergo handle set - Phillips, square, slotted and precision set in carry case Contains: SL: 3.0 x 75mm, 5.5 x 100mm, 6.5 x 100mm SQ #1 x 100mm, SQ #2 x 100mm, SQ #2 x 200mm PH #2 x 38mm, PH #0 x 75mm, PH #1 x 100mm, PH #2 x 100mm 6 Piece precision screwdriver set		16pc
WI31062	WIHA	VDE 1000V rated Screwdriver set Contains: SL 3.5 x 100mm, 5.5 x 125mm, PZ1 x 80mm, PZ2 x 100mm SQ1 x 100mm, SQ2 x 150mm		6pc
DRVDESET12	DRAPER	VDE 1000V Ergo interchangeable handle screwdriver set in roll case Contains: 1x Ergo screwdriver handle & 1x Precision screwdriver handle Slot: 0.6 x 3.5mm, 0.8 x 4.0mm, 1.0 x 5.5mm, 1.2 x 6.5mm, all 100mm Cross Slot: No.1 x 80mm, No.2 x 100mm PZ: No.1 x 80, No.2 x 100mm - PZ/SL: No.1 x 80mm, No.2 x 100mm		12pc
INTERCHANGEABLE SCREWDRIVER SETS:				
GFB356	GFB	Ratchet screwdriver - magnetic holder with 12 x 25mm bits Contains: Hex: 5mm, 6mm Square: #1, #2 Torx: T20, T40 Pozi: #1, #2 Slotted: 5mm Phillips: #1, #2, #3		
DRISS-10	DRAPER	Impact screwdriver set - 10 piece		
GN8071	GENERAL	Ratchet offset screwdriver handle - with 4 bits		
JEWELLERS and PRECISION SCREWDRIVER SETS:				
DRPSD6	DRAPER	Precision screwdriver set of 6 Contains: Plain slotted: 1.0mm, 1.4mm, 2.0mm Cross slotted (PH): 00, 0, 1		
DRPSS-32	DRAPER	Precision screwdriver set of 32 Contains: 1 x Precision Screwdriver Handle, 1 x Magnetic bit holder 6 x Plain slot: 1.5, 2, 2.5, 3, 3.5, 4mm; 4 x PH-Type: No.000, No.00, No.0, No.1 9 x Draper TX-STAR®: T4, T5, T6, T7, T8, T9, T10, T15, T20; 1 x 2.6mm Spanner 7 x Hex: 0.9, 1.3, 1.5, 2, 2.5, 3, 4mm; 2 x Star: 0.8, 1.2mm; 1 x Tri-wing: No.2.0		
DR942-14	DRAPER	VDE Insulated and Precision screwdriver set of 14 Contains: 2 x Plain slot screwdrivers: 5.5 x 125, 6.5 x 150mm 3 x PH-1 type screwdrivers: No.1 x 80mm, No.2 x 100mm, No.3 x 150mm 3 x PZ-Type screwdrivers: No.1 x 80mm, No.2 x 100mm, No.3 x 150mm 3 x Plain slot: 2, 2.5, 3mm; 3 x PH-type: No.000, No.00, No.0		
NUT SETTERS:				tip size
DRNSP-06	DRAPER	Soft cushion grip screwdriver nutspinner		06mm
DRNSP-07	DRAPER	Soft cushion grip screwdriver nutspinner		07mm
DRNSP-08	DRAPER	Soft cushion grip screwdriver nutspinner		08mm
DRNSP-10	DRAPER	Soft cushion grip screwdriver nutspinner		10mm
SCREW EXTRACTORS:				size
BOA17001	BOA	Grabbit screw/bolt removal system - set of 2		
MA37332	MAYHEW	Screw extractor set of 5 in plastic wallet - fluted		
DR3062-07	DRAPER	Screw extractor for M24 - 33 screws		No.7
DR3062-08	DRAPER	Screw extractor for M33 - 45 screws		No.8
PT1798	PLUMTOOL	Franz Pipe Remover Kit - 1/2" & 3/4"		



MA37332
Screw extractor set



BOA17001
Grabbit screw and bolt remover set



PT1798
Franz Pipe Remover Kit



DR3062-07
Screw Extractor
No.7



DR3062-08
Screw Extractor
No.8



GN8071
Ratchet offset screwdriver set



DRISS-10
Impact screwdriver set



DRPSS-32
Precision screwdriver set



DRPSD6
Jewellers screwdriver set



DRNSP-08
8mm Nutspinner



GFB356
Ratchet screwdriver and bit set



FT108-0016
16pc Screwdriver set



ST65-005
Screwdriver set



ST65-750
Screwdriver set



DRVDESET12
Interchangeable VDE Screwdriver set



DR942-14
VDE Screwdriver set



WI31062
VDE Screwdriver set

70			Tip Size	Short Arm	Long Arm
BALL HEX-L KEYS (BULK)					
EK186-0150	EKLIND	Metric Ball-Hex-L Key	1.5mm	14mm	77mm
EK186-0200	EKLIND	Metric Ball-Hex-L Key	2.0mm	16mm	81mm
EK186-0900	EKLIND	Metric Ball-Hex-L Key	9.0mm	39mm	167mm
EK186-1400	EKLIND	Metric Ball-Hex-L Key	14.0mm	55mm	232mm
EK186-1700	EKLIND	Metric Ball-Hex-L Key	17.0mm	61mm	246mm
EK186-1900	EKLIND	Metric Ball-Hex-L Key	19.0mm	69mm	276mm
BALL HEX L KEYS (HANG SELL / BARCODED)					
EK143-0564	EKLIND	Imperial Ball-Hex-L Key	5/64"	16mm	81mm
EK143-0664	EKLIND	Imperial Ball-Hex-L Key	3/32"	17mm	86mm
EK143-0764	EKLIND	Imperial Ball-Hex-L Key	7/64"	18mm	90mm
EK143-0864	EKLIND	Imperial Ball-Hex-L Key	1/8"	19mm	95mm
EK143-0964	EKLIND	Imperial Ball-Hex-L Key	9/64"	20mm	100mm
EK143-1064	EKLIND	Imperial Ball-Hex-L Key	5/32"	21mm	105mm
EK143-1264	EKLIND	Imperial Ball-Hex-L Key	3/16"	24mm	114mm
EK143-1464	EKLIND	Imperial Ball-Hex-L Key	7/32"	26mm	124mm
EK143-1664	EKLIND	Imperial Ball-Hex-L Key	1/4"	28mm	133mm
EK143-2064	EKLIND	Imperial Ball-Hex-L Key	5/16"	32mm	152mm
EK143-2464	EKLIND	Imperial Ball-Hex-L Key	3/8"	35mm	171mm
EK143-3264	EKLIND	Imperial Ball-Hex-L Key	1/2"	41mm	210mm
EK144-0130	EKLIND	Metric Ball-Hex-L Key	1.3mm	14mm	72mm
EK144-0150	EKLIND	Metric Ball-Hex-L Key	1.5mm	14mm	77mm
EK144-0200	EKLIND	Metric Ball-Hex-L Key	2mm	16mm	81mm
EK144-0250	EKLIND	Metric Ball-Hex-L Key	2.5mm	18mm	88mm
EK144-0300	EKLIND	Metric Ball-Hex-L Key	3mm	19mm	99mm
EK144-0350	EKLIND	Metric Ball-Hex-L Key	3.5mm	21mm	102mm
EK144-0400	EKLIND	Metric Ball-Hex-L Key	4mm	24mm	104mm
EK144-0450	EKLIND	Metric Ball-Hex-L Key	4.5mm	25mm	110mm
EK144-0500	EKLIND	Metric Ball-Hex-L Key	5mm	27mm	116mm
EK144-0600	EKLIND	Metric Ball-Hex-L Key	6mm	31mm	138mm
EK144-0700	EKLIND	Metric Ball-Hex-L Key	7mm	35mm	157mm
EK144-0800	EKLIND	Metric Ball-Hex-L Key	8mm	35mm	157mm
EK144-0900	EKLIND	Metric Ball-Hex-L Key	9mm	39mm	167mm
EK144-1000	EKLIND	Metric Ball-Hex-L Key	10mm	39mm	167mm
EK144-1200	EKLIND	Metric Ball-Hex-L Key	12mm	39mm	209mm
EK144-1400	EKLIND	Metric Ball-Hex-L Key	14mm	39mm	232mm
EK144-1700	EKLIND	Metric Ball-Hex-L Key	17mm	39mm	246mm
POWER-T™ BALL KEYS					
EK618-0564	EKLIND	Imperial Power-T T-Handle Ball-Hex Key	5/64"	76mm	229mm
EK618-1264	EKLIND	Imperial Power-T T-Handle Ball-Hex Key	3/16"	102mm	229mm
EK618-1664	EKLIND	Imperial Power-T T-Handle Ball-Hex Key	1/4"	102mm	229mm
EK618-2464	EKLIND	Imperial Power-T T-Handle Ball-Hex Key	3/8"	127mm	229mm
EK648-0200	EKLIND	Metric Power-T T-Handle Ball-Hex Key	2.0mm	76mm	229mm
EK648-0250	EKLIND	Metric Power-T T-Handle Ball-Hex Key	2.5mm	76mm	229mm
EK648-0300	EKLIND	Metric Power-T T-Handle Ball-Hex Key	3.0mm	76mm	229mm
EK648-0400	EKLIND	Metric Power-T T-Handle Ball-Hex Key	4.0mm	76mm	229mm
EK648-0500	EKLIND	Metric Power-T T-Handle Ball-Hex Key	5.0mm	102mm	229mm
EK648-0600	EKLIND	Metric Power-T T-Handle Ball-Hex Key	6.0mm	102mm	229mm
EK648-0800	EKLIND	Metric Power-T T-Handle Ball-Hex Key	8.0mm	127mm	229mm
EK648-1000	EKLIND	Metric Power-T T-Handle Ball-Hex Key	10.0mm	127mm	229mm



EK186
Ball Hex Key
(Bulk)



EK143 & EK144
Ball Hex Key
(Carded)



EK618
Power-T Ball Hex Key
(Imperial)



EK648
Power-T Ball Hex Key
(Metric)

HEX-L KEYS (BULK)
Tip Size
Short Arm
Long Arm

EK155-0200	EKLIND	Metric Short Hex-L Key	2.0mm	16mm	49mm
EK155-0250	EKLIND	Metric Short Hex-L Key	2.5mm	18mm	55mm
EK155-0300	EKLIND	Metric Short Hex-L Key	3.0mm	19mm	62mm
EK155-0350	EKLIND	Metric Short Hex-L Key	3.5mm	21mm	65mm
EK155-0400	EKLIND	Metric Short Hex-L Key	4.0mm	24mm	68mm
EK155-0500	EKLIND	Metric Short Hex-L Key	5.0mm	27mm	78mm
EK155-0800	EKLIND	Metric Short Hex-L Key	8.0mm	35mm	98mm
EK155-1700	EKLIND	Metric Short Hex-L Key	17.0mm	62mm	156mm
EK155-1900	EKLIND	Metric Short Hex-L Key	19.0mm	69mm	176mm
EK155-2200	EKLIND	Metric Short Hex-L Key	22.0mm	69mm	210mm
EK155-2400	EKLIND	Metric Short Hex-L Key	24.0mm	69mm	240mm
EK156-0300	EKLIND	Metric Long Hex-L Key	3.0mm	19mm	98mm
EK156-0400	EKLIND	Metric Long Hex-L Key	4.0mm	23mm	103mm
EK156-0500	EKLIND	Metric Long Hex-L Key	5.0mm	26mm	116mm
EK156-0600	EKLIND	Metric Long Hex-L Key	6.0mm	31mm	137mm
EK156-1700	EKLIND	Metric Long Hex-L Key	17.0mm	61mm	245mm
EK156-1900	EKLIND	Metric Long Hex-L Key	19.0mm	68mm	275mm
EK156-2200	EKLIND	Metric Long Hex-L Key	22.0mm	78mm	330mm
EK156-2400	EKLIND	Metric Long Hex-L Key	24.00mm	87mm	361mm

HEX-L KEYS (HANG SELL / BARCODED)
Tip Size
Short Arm
Long Arm

EK142-0664	EKLIND	Carded Imperial Long Hex-L Key	3/32"	17mm	50mm
EK142-0764	EKLIND	Carded Imperial Long Hex-L Key	7/64"	18mm	53mm
EK142-0864	EKLIND	Carded Imperial Long Hex-L Key	1/8"	19mm	57mm
EK142-0964	EKLIND	Carded Imperial Long Hex-L Key	9/64"	20mm	60mm
EK142-1064	EKLIND	Carded Imperial Long Hex-L Key	5/32"	21mm	63mm
EK142-1264	EKLIND	Carded Imperial Long Hex-L Key	3/16"	24mm	70mm
EK142-1464	EKLIND	Carded Imperial Long Hex-L Key	7/32"	26mm	76mm
EK142-1664	EKLIND	Carded Imperial Long Hex-L Key	1/4"	28mm	83mm
EK142-2864	EKLIND	Imperial Long Hex-L Key	7/16"	38mm	191mm
EK142-3264	EKLIND	Imperial Long Hex-L Key	1/2"	41mm	209mm
EK146-0250	EKLIND	Carded Metric Long Hex-L Key	2.5mm	17mm	54mm
EK146-0300	EKLIND	Carded Metric Long Hex-L Key	3.0mm	19mm	61mm
EK146-0400	EKLIND	Carded Metric Long Hex-L Key	4.0mm	23mm	68mm
EK146-0500	EKLIND	Carded Metric Long Hex-L Key	5.0mm	26mm	78mm
EK146-0600	EKLIND	Carded Metric Long Hex-L Key	6.0mm	31mm	87mm
EK146-0800	EKLIND	Carded Metric Long Hex-L Key	8.0mm	35mm	97mm
EK146-1000	EKLIND	Carded Metric Long Hex-L Key	10.0mm	39mm	109mm
EK146-1200	EKLIND	Metric Long Hex-L Key	12.0mm	43mm	121mm
EK146-1400	EKLIND	Metric Long Hex-L Key	14.0mm	54mm	136mm
EK146-1700	EKLIND	Metric Long Hex-L Key	17.0mm	61mm	156mm



EK155
Short Hex-L key
(bulk)



EK156
Long Hex-L key
(bulk)



EK142 & EK146
Short Hex-L key
(Carded)

72					
POWER-T™ HEX KEYS:			Tip Size	Handle Width	Long Arm
EK649-0200	EKLIND	Metric Slip resistant T-handle hex end keys	2.0mm	76mm	229mm
EK649-0250	EKLIND	Metric Slip resistant T-handle hex end keys	2.5mm	76mm	229mm
EK649-0300	EKLIND	Metric Slip resistant T-handle hex end keys	3.0mm	76mm	229mm
EK649-0400	EKLIND	Metric Slip resistant T-handle hex end keys	4.0mm	76mm	229mm
EK649-0500	EKLIND	Metric Slip resistant T-handle hex end keys	5.0mm	102mm	229mm
EK649-0600	EKLIND	Metric Slip resistant T-handle hex end keys	6.0mm	102mm	229mm
EK649-0700	EKLIND	Metric Slip resistant T-handle hex end keys	7.0mm	102mm	229mm
EK649-0800	EKLIND	Metric Slip resistant T-handle hex end keys	8.0mm	127mm	229mm
EK686-TX07	EKLIND	Power T torx key - slip resistant	T-7	76mm	152mm
EK686-TX08	EKLIND	Power T torx key - slip resistant	T-8	76mm	152mm
EK686-TX09	EKLIND	Power T torx key - slip resistant	T-9	76mm	152mm
EK686-TX10	EKLIND	Power T torx key - slip resistant	T-10	76mm	152mm
EK686-TX15	EKLIND	Power T torx key - slip resistant	T-15	76mm	152mm
EK686-TX20	EKLIND	Power T torx key - slip resistant	T-20	76mm	152mm
EK686-TX25	EKLIND	Power T torx key - slip resistant	T-25	76mm	152mm
EK686-TX27	EKLIND	Power T torx key - slip resistant	T-27	102mm	152mm
EK686-TX30	EKLIND	Power T torx key - slip resistant	T-30	102mm	152mm
FOLD UP KEY SETS:			size range		
EK25911	EKLIND	Hex key set of 9 - Ergofold case	5/64" - 1/4"		
EK25912	EKLIND	Hex key set of 9 - Ergofold case	0.050" - 3/16"		
EK25161	EKLIND	Hex key set of 6 - Ergofold case	3.0mm - 10.0mm		
EK25171	EKLIND	Hex key set of 7 - Ergofold case	1.5mm - 6.0mm		
EK25172	EKLIND	Hex key set of 7 - Ergofold case	2.0mm - 8.0mm		
EK25570	EKLIND	Tamperproof Torx key set of 7 - Ergofold case	TX10 - TX40		
EK25581	EKLIND	Torx key set of 8 - Ergofold case	TX8 - TX25		
EK25582	EKLIND	Torx key set of 8 - Ergofold case	TX6 - TX25		
HEX-L KEY SETS:			size range		
EK10507	EKLIND	Hex-L key set of 7 short series - plastic holder	1.5mm - 6.0mm		
EK10607	EKLIND	Hex-L key set of 7 long series - plastic holder	1.5mm - 6.0mm		
EK10509	EKLIND	Hex-L key set of 9 short series - plastic holder	1.5mm - 10.0mm		
EK10609	EKLIND	Hex-L key set of 9 long series - plastic holder	1.5mm - 10.0mm		
EK10207	EKLIND	Hex-L key set of 7 long series - plastic holder	5/64" - 1/4"		
EK10111	EKLIND	Hex-L key set of 11 short series - plastic holder	0.050" - 1/4"		
EK10113	EKLIND	Hex-L key set of 13 short series - plastic holder	0.050" - 3/8"		
EK10213	EKLIND	Hex-L key set of 13 long series - plastic holder	0.050 - 3/8"		
FT130-6651	FULLER	Hex key set of 10 - keyring	1.5mm - 10mm		
EK10222	EKLIND	Combo Hex-L set of 22 long series	1.5mm - 10.0mm 0.050 - 3/8"		
DRLCHKS-9	DRAPER	Metric 9pc Long Arm Hex Key Set, Colour Coded	1.5mm - 10mm		
BALL HEX-L SETS:			size range		
EK13213	EKLIND	Imperial 13pc LONG SERIES - plastic holder .050, 1/16, 5/64, 3/32, 7/64, 1/8, 9/64, 5/32, 3/16, 7/32, 1/4, 5/16, 3/8	0.050" - 3/8"		
EK13607	EKLIND	Metric 7pc LONG SERIES - plastic holder 1.5, 2, 2.5, 3, 4, 5, 6mm	1.5mm - 6.0mm		
EK13609	EKLIND	Metric 9pc LONG SERIES - plastic holder 1.5, 2, 2.5, 3, 4, 5, 6, 8, 10mm	1.5mm - 10.0mm		
EK13222	EKLIND	Metric/Imperial 22pc Combo pack LONG SERIES - plastic holder EK13213 13pc Imperial set EK13609 9pc Metric set	0.050" - 3/8" 1.5mm - 10.0mm		
DRSCBHKS-9	DRAPER	Metric 9pc Short Arm Hex Key Set, Colour Coded 1.5, 2, 2.5, 3, 4, 5, 6, 8, 10mm	1.5mm - 10.0mm		
BALL HEX FOLD-UP SETS:			size range		
EK25919	EKLIND	Imperial 9pc set - Ergofold case 5/16, 3/32, 7/64, 1/8, 9/64, 5/32, 3/16, 7/32, 1/4"	5/64" - 1/4"		
EK25159	EKLIND	Metric 5pc set - Ergofold case 4, 5, 6, 8, 10mm	4.0mm - 10.0mm		
EK25169	EKLIND	Metric 6pc set - Ergofold case 2, 2.5, 3, 4, 5, 6mm	2.0mm - 6.0mm		



EK649
Power T™ Hex Key
(Metric)



EK686
Power T™ Torx Key



FT130-6651
Keyring Hex Key Set
(Metric)



EK251
Ergo-Fold Hex Key Set
(Imperial)



EK251
Ergo-Fold Ball Key Set
(Imperial)



EK259
Ergo-Fold Hex Key Set
(Metric)



EK259
Ergo-Fold Ball Key Set
(Metric)



EK255
Ergo-Fold Torx Key Set



EK10222
Plastic Holder Hex Key Set



EK13222
Plastic Holder Ball Key Set



DRLCHKS-9
Hex Key Set
Colour Coded
(Metric)



DRSCBHS-9
Ball Key Set
Colour Coded
(Metric)

STARRETT FAST CUT HOLESAWS:
Size

SRFCH-16	STARRETT	Fast cut holesaw	16.0mm
SRFCH-105	STARRETT	Fast cut holesaw	105.0mm
SRFCH-127	STARRETT	Fast cut holesaw	127.0mm

STARRETT DEEP CUT HOLESAWS:
Size

SRDCH-19	STARRETT	Deep cut Holesaw - 51mm cutting depth	19.0mm
SRDCH-20	STARRETT	Deep cut Holesaw - 51mm cutting depth	20.0mm
SRDCH-22	STARRETT	Deep cut Holesaw - 51mm cutting depth	22.0mm
SRDCH-25	STARRETT	Deep cut Holesaw - 51mm cutting depth	25.0mm
SRDCH-29	STARRETT	Deep cut Holesaw - 51mm cutting depth	29.0mm
SRDCH-32	STARRETT	Deep cut Holesaw - 51mm cutting depth	32.0mm
SRDCH-35	STARRETT	Deep cut Holesaw - 51mm cutting depth	35.0mm
SRDCH-38	STARRETT	Deep cut Holesaw - 51mm cutting depth	38.0mm
SRDCH-41	STARRETT	Deep cut Holesaw - 51mm cutting depth	41.0mm
SRDCH-44	STARRETT	Deep cut Holesaw - 51mm cutting depth	44.0mm
SRDCH-48	STARRETT	Deep cut Holesaw - 51mm cutting depth	48.0mm
SRDCH-51	STARRETT	Deep cut Holesaw - 51mm cutting depth	51.0mm
SRDCH-54	STARRETT	Deep cut Holesaw - 51mm cutting depth	54.0mm
SRDCH-57	STARRETT	Deep cut Holesaw - 51mm cutting depth	57.0mm
SRDCH-60	STARRETT	Deep cut Holesaw - 51mm cutting depth	60.0mm
SRDCH-64	STARRETT	Deep cut Holesaw - 51mm cutting depth	64.0mm
SRDCH-65	STARRETT	Deep cut Holesaw - 51mm cutting depth	65.0mm
SRDCH-70	STARRETT	Deep cut Holesaw - 51mm cutting depth	70.0mm
SRDCH-76	STARRETT	Deep cut Holesaw - 51mm cutting depth	76.0mm
SRDCH-79	STARRETT	Deep cut Holesaw - 51mm cutting depth	79.0mm
SRDCH-83	STARRETT	Deep cut Holesaw - 51mm cutting depth	83.0mm
SRDCH-86	STARRETT	Deep cut Holesaw - 51mm cutting depth	86.0mm
SRDCH-89	STARRETT	Deep cut Holesaw - 51mm cutting depth	89.0mm
SRDCH-92	STARRETT	Deep cut Holesaw - 51mm cutting depth	92.0mm
SRDCH-102	STARRETT	Deep cut Holesaw - 51mm cutting depth	102.0mm
SRDCH-105	STARRETT	Deep cut Holesaw - 51mm cutting depth	105.0mm
SRDCH-108	STARRETT	Deep cut Holesaw - 51mm cutting depth	108.0mm
SRDCH-111	STARRETT	Deep cut Holesaw - 51mm cutting depth	111.0mm
SRDCH-114	STARRETT	Deep cut Holesaw - 51mm cutting depth	114.0mm
SRDCH-121	STARRETT	Deep cut Holesaw - 51mm cutting depth	121.0mm
SRDCH-127	STARRETT	Deep cut Holesaw - 51mm cutting depth	127.0mm
SRDCH-133	STARRETT	Deep cut Holesaw - 51mm cutting depth	133.0mm
SRDCH-152	STARRETT	Deep cut Holesaw - 51mm cutting depth	152.0mm
SRDCH-168M	STARRETT	Deep cut Holesaw - 51mm cutting depth	168.0mm
SRDCH-177M	STARRETT	Deep cut Holesaw - 51mm cutting depth	177.0mm
SRDCH-210M	STARRETT	Deep cut Holesaw - 51mm cutting depth	210.0mm

STARRETT SMOOTH CUT HOLESAWS:
size

SRKCSC-22	STARRETT	Smooth cut Holesaw	22.0mm
SRKCSC-25	STARRETT	Smooth cut Holesaw	25.0mm
SRKCSC-29	STARRETT	Smooth cut Holesaw	29.0mm
SRKCSC-32	STARRETT	Smooth cut Holesaw	32.0mm
SRKCSC-35	STARRETT	Smooth cut Holesaw	35.0mm
SRKCSC-38	STARRETT	Smooth cut Holesaw	38.0mm



SRFCH-16
Fast cut holesaw



SRFCH-105
Fast cut holesaw



SRFCH-127
Fast cut holesaw



SRKSC-22
Smooth cut holesaw



SRKSC-25
Smooth cut holesaw



SRKSC-29
Smooth cut holesaw



SRKSC-32
Smooth cut holesaw



SRKSC-35
Smooth cut holesaw



SRKSC-38
Smooth cut holesaw



SRDCH-19
Deep cut holesaw



SRDCH-29
Deep cut holesaw



SRDCH-54
Deep cut holesaw



SRDCH-76
Deep cut holesaw



SRDCH-89
Deep cut holesaw



SRDCH-102
Deep cut holesaw



SRDCH-114
Deep cut holesaw



SRDCH-152
Deep cut holesaw



SRDCH-177M
Deep cut holesaw

TCT MULTI-PURPOSE HOLESAWS:
size

SRMPH-19	STARRETT	TCT multi-purpose holesaw	19mm
SRMPH-20	STARRETT	TCT multi-purpose holesaw	20mm
SRMPH-22	STARRETT	TCT multi-purpose holesaw	22mm
SRMPH-25	STARRETT	TCT multi-purpose holesaw	25mm
SRMPH-29	STARRETT	TCT multi-purpose holesaw	28mm
SRMPH-30	STARRETT	TCT multi-purpose holesaw	30mm
SRMPH-32	STARRETT	TCT multi-purpose holesaw	32mm
SRMPH-35	STARRETT	TCT multi-purpose holesaw	35mm
SRMPH-38	STARRETT	TCT multi-purpose holesaw	38mm
SRMPH-41	STARRETT	TCT multi-purpose holesaw	41mm
SRMPH-44	STARRETT	TCT multi-purpose holesaw	44mm
SRMPH-48	STARRETT	TCT multi-purpose holesaw	48mm
SRMPH-51	STARRETT	TCT multi-purpose holesaw	51mm
SRMPH-54	STARRETT	TCT multi-purpose holesaw	54mm
SRMPH-57	STARRETT	TCT multi-purpose holesaw	57mm
SRMPH-60	STARRETT	TCT multi-purpose holesaw	60mm
SRMPH-64	STARRETT	TCT multi-purpose holesaw	64mm
SRMPH-68	STARRETT	TCT multi-purpose holesaw	68mm
SRMPH-70	STARRETT	TCT multi-purpose holesaw	70mm
SRMPH-76	STARRETT	TCT multi-purpose holesaw	76mm
SRMPH-79	STARRETT	TCT multi-purpose holesaw	79mm
SRMPH-83	STARRETT	TCT multi-purpose holesaw	83mm
SRMPH-86	STARRETT	TCT multi-purpose holesaw	86mm
SRMPH-89	STARRETT	TCT multi-purpose holesaw	89mm
SRMPH-92	STARRETT	TCT multi-purpose holesaw	92mm
SRMPH-102	STARRETT	TCT multi-purpose holesaw	102mm
SRMPH-111	STARRETT	TCT multi-purpose holesaw	111mm
SRMPH-114	STARRETT	TCT multi-purpose holesaw	114mm
SRMPH-118	STARRETT	TCT multi-purpose holesaw	118mm
SRMPH-121	STARRETT	TCT multi-purpose holesaw	121mm
SRMPH-127	STARRETT	TCT multi-purpose holesaw	127mm
SRMPH-152	STARRETT	TCT multi-purpose holesaw	152mm
SRMPH-159	STARRETT	TCT multi-purpose holesaw	159mm

STARRETT HOLESAW ACCESSORIES:
size

SRKA014C-E	STARRETT	HSS Pilot drill bit - Carded	80mm
SRKA014CE-E	STARRETT	Pilot drill bit - Carded	90mm
SRKXA014C-E	STARRETT	TCT pilot drill - carded	100mm
SRA015C	STARRETT	Kwik change pilot drill	119mm
SRHSA1	STARRETT	Arbor grub screw only - For sizes 14.0 - 30.0mm	
SRA17-38E	STARRETT	LOCKING ARBOR - For sizes 32mm - 210.0mm	
SRKA19-E	STARRETT	OOPS Hole Enlargement Arbor	
SRA1E	STARRETT	HSS EXTENDED LENGTH ARBOR - For sizes 14.0mm - 30.0mm	
SRA2E	STARRETT	HSS EXTENDED LENGTH ARBOR - For sizes 32.0mm - 210.0mm	



SRKA014C-E
HSS Pilot drill



SRKXA014C-E
TCT Pilot drill

SRA1E
Holesaw arbor



SRA2E
Holesaw arbor



SRA17-38E
Locking Holesaw arbor



SRKA19-E
Oops Holesaw arbor



SRMPH-25
TCT holesaw



SRMPH-38
TCT holesaw



SRMPH-44
TCT holesaw



SRMPH-51
TCT holesaw



SRMPH-70
TCT holesaw



SRMPH-83
TCT holesaw



SRMPH-92
TCT holesaw



SRMPH-121
TCT holesaw



SRMPH-152
TCT holesaw

HOLESAW SETS: BI-METAL, TCT, TCG

MRMHS040PNZ	MORSE	NZ PLUMBERS holesaw set of 8 - variable pitch 1-1/2" depth of cut 38mm, 41mm, 44mm, 57mm, 64mm, 86mm holesaws 1 each MRMA45PSC arbor, MR4PD spare pilot drill	
MRMHS06I	MORSE	INDUSTRIAL holesaw set of 19 - variable pitch 1-1/2" depth of cut 1 each 19, 22, 29, 35, 38, 44, 51, 57, 64, 76, 83, 92, 95, 108, 114mm holesaws 1x MRMA24C, MRMA34C, MRMA45PSC arbors 1x MR12E extension	
SRKD06041-N	STARRETT	DIAMOND DRILL BIT HOLESAW KIT 1 each 5.0mm, 6.0mm, 6.5mm, 8.0mm, 10.0mm, 12.0mm 1 each Extrator pin, Water tank, Hole guide.	
MRMHSG100	MORSE	TUNGSTEN CARBIDE GRIT holesaw set of 11 1x each 19, 22, 29, 35, 38, 44, 51, 57, 64mm TCG holesaws 1x each MRMA24CT, MRMA45PSCT arbors	
SRKMP11021	STARRETT	TCT General purpose holesaw set – 12pc holesaw set Contains: 1x each 19, 22, 29, 35, 38, 44, 51, 54, 57, 64, 68, 76mm TCT holesaws A1E and A17-38E arbors, 1x pilot drill	Gen Purpose
SRKMP12011	STARRETT	TCT General purpose holesaw set – 12pc holesaw set Contains: 1x each 35, 40, 44, 51, 60, 65, 70, 73, 76, 83, 86, 92mm TCT holesaws 1x SRKXA17-38 Arbor	Downlight set
SRKDC13021	STARRETT	General Purpose Deep Cut Holesaw Set – 13pc Contains: 1x each 20, 22, 25, 29, 32, 35, 38, 44 51, 57, 64, 68, 76mm Bi-Metal holesaws 1x each A1E Extended, A2E Quick-Hitch arbors	Gen Purpose
SRKDC07021	STARRETT	#KDC07021 Bi-Metal Plumbers holesaw Set - 7pc Contains: 1x each 19, 22, 29, 38, 44, 51, 57mm Deep Cut holesaws 1x each SRA1E & SRA10E arbors	Plumbers
SRKMP09021	STARRETT	#KMP09021 TCT HOLESAW SET - 9pc holesaw set Contains: 1x each 19, 22, 29, 35, 44, 51, 57, 64, 68mm TCT Holesaws, 1x SRKXA014C-E TCT pilot drill 1x SRA1E & SRA17-38E Arbors,	Gen Purpose
SRKCS06001	STARRETT	#KCS06001 Bi-Metal Cordless Holesaw kit - 6pc Contains: 1x each 16, 20, 22, 25, 32, 40mm Bi-Metal holesaws	Gen Purpose



MRMHS061
Industrial holesaw set
19pc Bi-Metal



MRMHS040PNZ
Plumbers holesaw set
8pc Bi-Metal



SRKMP09021
General purpose holesaw kit
9pc TCT



SRKD06041-N
Plumbers/Electricians tile drill kit
6pc Diamond bits



SRKMP12011
General purpose holesaw kit
12pc TCT



SRKDC07021
Plumbers holesaw kit
7pc Bi-metal



SRKDC13021
General purpose holesaw kit
13pc Bi-Metal



SRKMP11021
General purpose holesaw kit
12pc TCT



SRKCS06001
Cordless holesaw kit
6pc Bi-metal



MRMHSG100
Tile/Masonry holesaw kit
11pc Tungsten Grit

BI-METAL HOLESAWS - SEPARATE ARBOR 1-1/2" cut depth
size soft metric

MRMHS10C	MORSE	Bi-metal variable pitch holesaw - clam shell pack	5/8"	16mm
MRMHS12C	MORSE	Bi-metal variable pitch holesaw - clam shell pack	3/4"	19mm
MRMHS13C	MORSE	Bi-metal variable pitch holesaw - clam shell pack	13/16"	21mm
MRMHS14C	MORSE	Bi-metal variable pitch holesaw - clam shell pack	7/8"	22mm
MRMHS15C	MORSE	Bi-metal variable pitch holesaw - clam shell pack	15/16"	24mm
MRMHS16C	MORSE	Bi-metal variable pitch holesaw - clam shell pack	1"	25mm
MRMHS17C	MORSE	Bi-metal variable pitch holesaw - clam shell pack	1-1/16"	27mm
MRMHS18C	MORSE	Bi-metal variable pitch holesaw - clam shell pack	1-1/8"	29mm
MRMHS19C	MORSE	Bi-metal variable pitch holesaw - clam shell pack	1-3/16"	30mm
MRMHS20C	MORSE	Bi-metal variable pitch holesaw - clam shell pack	1-1/4"	32mm
MRMHS21C	MORSE	Bi-metal variable pitch holesaw - clam shell pack	1-5/16"	33mm
MRMHS22C	MORSE	Bi-metal variable pitch holesaw - clam shell pack	1-3/8"	35mm
MRMHS24C	MORSE	Bi-metal variable pitch holesaw - clam shell pack	1-1/2"	38mm
MRMHS26C	MORSE	Bi-metal variable pitch holesaw - clam shell pack	1-5/8"	41mm
MRMHS28C	MORSE	Bi-metal variable pitch holesaw - clam shell pack	1-3/4"	44mm
MRMHS29C	MORSE	Bi-metal variable pitch holesaw - clam shell pack	1-13/16"	46mm
MRMHS30C	MORSE	Bi-metal variable pitch holesaw - clam shell pack	1-7/8"	48mm
MRMHS32C	MORSE	Bi-metal variable pitch holesaw - clam shell pack	2"	51mm
MRMHS33C	MORSE	Bi-metal variable pitch holesaw - clam shell pack	2-1/16"	52mm
MRMHS34C	MORSE	Bi-metal variable pitch holesaw - clam shell pack	2-1/8"	54mm
MRMHS36C	MORSE	Bi-metal variable pitch holesaw - clam shell pack	2-1/4"	57mm
MRMHS38C	MORSE	Bi-metal variable pitch holesaw - clam shell pack	2-3/8"	60mm
MRMHS40C	MORSE	Bi-metal variable pitch holesaw - clam shell pack	2-1/2"	64mm
MRMHS42C	MORSE	Bi-metal variable pitch holesaw - clam shell pack	2-1/2"	67mm
MRMHS44C	MORSE	Bi-metal variable pitch holesaw - clam shell pack	2-3/4"	70mm
MRMHS46C	MORSE	Bi-metal variable pitch holesaw - clam shell pack	2-7/8"	73mm
MRMHS48C	MORSE	Bi-metal variable pitch holesaw - clam shell pack	3"	76mm
MRMHS50C	MORSE	Bi-metal variable pitch holesaw - clam shell pack	3-1/8"	79mm
MRMHS52C	MORSE	Bi-metal variable pitch holesaw - clam shell pack	3-1/4"	83mm
MRMHS54C	MORSE	Bi-metal variable pitch holesaw - clam shell pack	3-3/8"	86mm
MRMHS55C	MORSE	Bi-metal variable pitch holesaw - clam shell pack	3-1/2"	89mm
MRMHS58C	MORSE	Bi-metal variable pitch holesaw - clam shell pack	3-5/8"	92mm
MRMHS60C	MORSE	Bi-metal variable pitch holesaw - clam shell pack	3-3/4"	95mm
MRMHS62C	MORSE	Bi-metal variable pitch holesaw - clam shell pack	3-7/8"	98mm
MRMHS64C	MORSE	Bi-metal variable pitch holesaw - clam shell pack	4"	102mm
MRMHS66	MORSE	Bi-metal variable pitch holesaw - box pack	4-1/8"	105mm
MRMHS68	MORSE	Bi-metal variable pitch holesaw - box pack	4-1/4"	108mm
MRMHS70	MORSE	Bi-metal variable pitch holesaw - box pack	4-3/8"	110mm
MRMHS72	MORSE	Bi-metal variable pitch holesaw - box pack	4-1/2"	114mm
MRMHS76	MORSE	Bi-metal variable pitch holesaw - box pack	4-3/4"	121mm
MRMHS80	MORSE	Bi-metal variable pitch holesaw - box pack	5"	127mm
MRMHS88	MORSE	Bi-metal variable pitch holesaw - box pack	5-1/2"	140mm
MRMHS96	MORSE	Bi-metal variable pitch holesaw - box pack	6"	152mm



MRMHS Holesaw
teeth view



MRMHS Holesaw
top view



MRMHS14C
22mm/7/8" Bi-metal holesaw



MRMHS33C
52mm/2-1/16" Bi-metal holesaw



MRMHS62C
98mm/3-7/8" Bi-metal holesaw



MRMHS60C
95mm/3-3/4" Bi-metal holesaw



MRMHS88
138mm/5-1/2" Bi-metal holesaw

TUNGSTEN CARBIDE TIPPED HOLESAWS:
soft metric

MRMHSTK12	MORSE	3/4"	Kraken tungsten carbide tipped holesaw - 3 tpi	19mm
MRMHSTK14	MORSE	7/8"	Kraken tungsten carbide tipped holesaw - 3 tpi	22mm
MRMHSTK16	MORSE	1"	Kraken tungsten carbide tipped holesaw - 3 tpi	25mm
MRMHSTK18	MORSE	1-1/8"	Kraken tungsten carbide tipped holesaw - 3 tpi	29mm
MRMHSTK20	MORSE	1-1/4"	Kraken tungsten carbide tipped holesaw - 3 tpi	32mm
MRMHSTK22	MORSE	1-3/8"	Kraken tungsten carbide tipped holesaw - 3 tpi	35mm
MRMHSTK24	MORSE	1-1/2"	Kraken tungsten carbide tipped holesaw - 3 tpi	38mm
MRMHSTK28	MORSE	1-3/4"	Kraken tungsten carbide tipped holesaw - 3 tpi	44mm
MRMHSTK32	MORSE	2"	Kraken tungsten carbide tipped holesaw - 3 tpi	51mm
MRMHSTK36	MORSE	2-1/4"	Kraken tungsten carbide tipped holesaw - 3 tpi	57mm
MRMHSTK38	MORSE	2-3/8"	Kraken tungsten carbide tipped holesaw - 3 tpi	61mm
MRMHSTK40	MORSE	2-1/2"	Kraken tungsten carbide tipped holesaw - 3 tpi	64mm
MRMHSTK44	MORSE	2-3/4"	Kraken tungsten carbide tipped holesaw - 3 tpi	70mm
MRMHSTK48	MORSE	3"	Kraken tungsten carbide tipped holesaw - 3 tpi	76mm
MRMHSTK52	MORSE	3-1/4"	Kraken tungsten carbide tipped holesaw - 3 tpi	83mm
MRMHSTK54	MORSE	3-3/8"	Kraken tungsten carbide tipped holesaw - 3 tpi	86mm
MRMHSTK56	MORSE	3-1/2"	Kraken tungsten carbide tipped holesaw - 3 tpi	89mm
MRMHSTK58	MORSE	3-5/8"	Kraken tungsten carbide tipped holesaw - 3 tpi	92mm
MRMHSTK64	MORSE	4"	Kraken tungsten carbide tipped holesaw - 3 tpi	102mm
MRMHSTK70	MORSE	4-3/8"	Kraken tungsten carbide tipped holesaw - 3 tpi	110mm
MRMHSTK72	MORSE	4-1/2"	Kraken tungsten carbide tipped holesaw - 3 tpi	114mm
MRMHSTK76	MORSE	4-3/4"	Kraken tungsten carbide tipped holesaw - 3 tpi	121mm
MRMHSTK80	MORSE	5"	Kraken tungsten carbide tipped holesaw - 3 tpi	127mm
MRMHSTK96	MORSE	6"	Kraken tungsten carbide tipped holesaw - 3 tpi	152mm

CARBIDE TIPPED HOLE CUTTERS:
soft metric

MRCT32	MORSE	1-3/8"	Carbide tipped hole cutter	32mm
MRCT35	MORSE	1 1/4"	Carbide tipped hole cutter	35mm
MRXCTSP	MORSE		Replacement drill bit only for MRCT series	
SRSM20	STARRETT	25/32"	Carbide tipped hole cutter - 1/2" cutting depth	20mm
SRSM22	STARRETT	7/8"	Carbide tipped hole cutter - 1/2" cutting depth	22mm
SRSM25	STARRETT	1"	Carbide tipped hole cutter - 1/2" cutting depth	25mm
SRSM35	STARRETT	1 3/8"	Carbide tipped hole cutter - 1/2" cutting depth	35mm
SRCT-035	STARRETT	1-3/8"	Triple Chip carbide tipped holesaw	35mm
SRCT-121	STARRETT	4-3/4"	Triple Chip carbide tipped holesaw	121mm

HOLES AW ARBORS & ACCESSORIES:
length

MR4PDC	MORSE	Standard pilot drill - carded		110mm
MRMAPD3CT	MORSE	Tungsten carbide tipped short pilot drill		79mm
MR4PDS	MORSE	Short pilot drill - bulk packed		78mm
MR4PDSC	MORSE	Short pilot drill - carded		78mm
MRMA24C	MORSE	Screw on arbor without lock pins For holesaws 9/16" - 1-3/16"	6mm round	MR4PD
MRMA34C	MORSE	Screw on arbor without lock pins For holesaws 9/16" - 1-3/16"	10mm hex	MR4PDS
MRMA35PSC	MORSE	Knurled screw down arbor with 2-pin lock For holesaws 1-1/4" - 6"	10mm hex	MR4PDS
MRMA45PSC	MORSE	Knurled screw down arbor with 2-pin lock For holesaws 1-1/4" - 6"	12mm hex	MR4PD



MRMA34C
10mm hex shank
screw on arbor



MRMA35PSC
10mm screw down
2 pin lock arbor



MRMA45PSC
12mm hex shank screw down
2 pin lock arbor



MRXCTSP
MRCT series replacement drill



SRSM22
Carbide tipped hole cutter



MRMHSTK16
25mm / 1" TCT holesaw



MRMHSTK64
102mm / 4" TCT holesaw



MRMHSTK96
152mm / 6" TCT holesaw



SRCT-035
35mm / 1-3/8" CT holesaw



SRCT-121
121mm / 4-3/4" CT holesaw



MR4PDC
110mm HSS pilot drill



MR4PDCS
70mm HSS pilot drill



MR4PDS
78mm HSS pilot drill



MRCT32/35
Carbide tipped hole cutter

TUNGSTEN CARBIDE GRIT HOLESAWS:
Size

MRMHSG36	MORSE	Tungsten carbide grit holesaw	57mm (2-1/4")
MRMHSG40	MORSE	Tungsten carbide grit holesaw	64mm (2-1/2")
MRMHSG44	MORSE	Tungsten carbide grit holesaw	70mm (2-3/4")
MRMHSG52	MORSE	Tungsten carbide grit holesaw	83mm (3-1/4")
MRMHSG54	MORSE	Tungsten carbide grit holesaw	86mm (3-3/8")

DIAMOND GRIT HOLESAWS/TILE DRILLS:
length
Size

MR105-05	MORSE	Diamond grit holesaw	100mm	5mm (3/16")
MR105-06	MORSE	Diamond grit holesaw	100mm	6mm (1/4")
MR105-08	MORSE	Diamond grit holesaw	100mm	8mm (5/16")
MR105-10	MORSE	Diamond grit holesaw	100mm	10mm (3/8")
MR105-13	MORSE	Diamond grit holesaw	100mm	13mm (1/2")
SR105-05	STARRETT	Diamond tile drill	60mm	5mm (3/16")
SR105-06	STARRETT	Diamond tile drill	60mm	6mm (15/64")
SR105-065	STARRETT	Diamond tile drill	60mm	6.5mm (1/4")
SR105-08	STARRETT	Diamond tile drill	60mm	8mm (5/16")
SR105-10	STARRETT	Diamond tile drill	60mm	10mm (3/8")
SR105-12	STARRETT	Diamond tile drill	60mm	12mm (1/2")
SRKD-TDG01	STARRETT	Diamond tile drill guide		

DIAMOND DRI CORE DRILL BIT:
Size

SRBMC-127	STARRETT	Diamond dri core drill	127mm
SRBMC-152	STARRETT	Diamond dri core drill	152mm



MR105-05
Diamond grit holesaw



MR105-06
Diamond grit holesaw



MR105-08
Diamond grit holesaw



MR105-10
Diamond grit holesaw



MR105-13
Diamond grit holesaw



SR105-05
Diamond tile drill



SR105-065
Diamond tile drill



SR105-06
Diamond tile drill



SR105-10
Diamond tile drill



SRKD-TDG01
Diamond tile drill guide



SRBMC Series
Diamond dri core
Masonry hole saw
(Further sizes available
on request)



MRMHSG40
64mm (2-1/2") TCG Holesaw



MRMHSG54
86mm (3-3/8") TCG Holesaw

MORSE RECIPROCATING SAW BLADES		TPI	Length	Width	Thickness	Quantity
Pallet Dismantler	MRB1010RRPB250	10	254mm	20mm	0.9mm	250 Box
Master Cobalt® Hybrid	MRB81014C5	10/14	203mm			5 Card
	MRB81014P		305mm	50 Tube		
	MRB12501014C5			1.3mm	5 Card	
	MRB12501014P		50 Tube			
Fire + Rescue	MFR66214	14	152mm	22mm	1.6mm	20 Tube
PRO Auto/Fire+Rescue	MFR66214C5					5 Card
	MFR66214T25		25 Tube			
	MFR96214C5		5 Card			
	MFR96214T25		25 Tube			
	MFR126214C5		5 Card			
MFR126214T25	25 Tube					
Havoc® Demolition	MRRB66206T	6	152mm	20 Tube		
	MRRB66210T	10	305mm	20 Tube		
	MRRB126210C3			3 Card		
	MRRB126210T			20 Tube		
PRO Demo-Wood	MRRB66206C5	6	152mm	5 Card		
	MRRB66206T25		25 Tube			
	MRRB96206C5		229mm	5 Card		
	MRRB96206T25			25 Tube		
	MRRB126206C5		305mm	5 Card		
	MRRB126206T25			25 Tube		
CTR Carbide Tipped	MRCTR908MC1	8	229mm	25mm	1.3mm	1 Card
Diamond Grit®	MRRBDG6C	Coarse	152mm	20mm	---	

STARRETT RECIPROCATING SAW BLADES		TPI	Length	Width	Thickness	Quantity
3X POWER Wood	SRBT96-5	6	228mm	19mm	1.27mm	5 Tube
3X POWER Multi	SRBT12610-2	6/10	305mm			2 Card
	SRBT910-2	10	228mm	2 Card		
	SRBT910-5			5 Tube		
3X POWER Metal	SRB614-2	14	152mm	0.89mm	2 Card	
	SRB614-5				5 Tube	
	SRB618-2	18			2 Card	
	SRB618-5				5 Tube	
3X HEAVY DUTY King Cut™	SRBTR6610-2	6/10	228mm	27mm	1.6mm	2 Card
	SRBTR6610-5					5 Tube
	SRBTR9610-2					2 Card
	SRBTR9610-5					5 Tube
	SRBTR12610-2					2 Card
	SRBTR12610-5					5 Tube
	SRBTR61014-2	10/14	152mm			2 Card
	SRBTR61014-5		5 Tube			
	SRBTR81014-2		203mm			2 Card
	SRBTR81014-5		5 Tube			
	SRBTR91014-2		228mm			2 Card
	SRBTR91014-5		5 Tube			
	SRBTR121014-2		305mm			2 Card
SRBTR121014-5	5 Tube					

RECIPROCATING SAW BLADE KITS		Quantity
SRKRB12-A	STARRETT 3X POWER Bi-Metal Reciprocating Blade Kit Contains: 1 x Wood, 3 x Multi, 3 x Metal, 5 x King Cut	12 Pack
MRRBKITHD01	MORSE Heavy Duty Bi-Metal Reciprocating Blade Kit Contains: 6 x Advanced Edge Power, 4 x Havoc, 2 x Fire+Rescue, 1 x Storage Tube	12 Pack
MRRBKITDM01	MORSE Demolition Bi-Metal Reciprocating Blade Kit Contains: 5 x Renovator, 6 x Havoc, 1 x Storage Tube	11 Pack
MRRBKITGP01	MORSE General Purpose Bi-Metal Reciprocating Blade Kit Contains: 2 x Master Cobalt Hybrid, 7 x Master Cobalt Metal, 8 x Master Cobalt Wood, 1 x Storage Tube	17 Pack

MASTER COBALT HYBRID



MRB81014
MRB12501014

3X POWER - METAL



SRB614
SRB618

FIRE + RESCUE



MRFR66214

3X POWER - MULTI



SRBT910
SRBT12610

PRO AUTO/FIRE+RESCUE

NEW 5 & 25 PACKS



MRFR66214
MRFR96214
MRFR126214

3X POWER - WOOD



SRBT96

HAVOC DEMOLITION



MRRB66206



SRBTR6610



MRRB66210
MRRB126210



SRBTR9610
SRBTR12610



6/10tpi x 305mm

PRO DEMO-WOOD

NEW 5 & 25 PACKS



MRRB66206
MRRB96206
MRRB126206



SRBTR61014



SRBTR81014



SRBTR91014



SRBTR121014



SRKRB12-A
Rescue & Demolition
12pc



MRRBKITDM01
Demolition
11pc



MRRBKITHD01
Heavy Duty
12pc



MRRBKITGP01
General Purpose
17pc



MRCTR908MC1
CTR Carbide Tipped



MRRBDG6C
Havoc Demolition

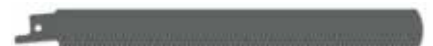

MRB1010RRPB250
Pallet Dismantler

80						
JIGSAW BLADES - U-SHANK:				Pack	tpi	length
GFB258	GFB	Medium cut for metal		3 pack	21tpi	70mm
GFB259	GFB	Scroll cut for wood		3 pack	12tpi	70mm
GFB260	GFB	Coarse cut for wood		3 pack	6tpi	100mm
GFB261	GFB	Taper ground for wood		3 pack	10tpi	100mm
GFB262	GFB	Taper ground for wood		3 pack	6tpi	100mm
JIGSAW BLADES - T-SHANK:				Pack	tpi	length
SRBU214-2	STARRETT	Bi-Metal jigsaw blade for wood & metal		2 pack	14tpi	50mm
SRBU218-2	STARRETT	Bi-Metal jigsaw blade for wood & metal		2 pack	18tpi	50mm
SRBU232-2	STARRETT	Bi-Metal jigsaw blade for metal		2 pack	32tpi	50mm
SRBU214S-2	STARRETT	Bi-Metal jigsaw blade for wood & metal		2 pack	14tpi	50mm
SRBU36-2	STARRETT	Bi-Metal jigsaw blade for wood		2 pack	6tpi	75mm
SRBU38-2	STARRETT	Bi-Metal jigsaw blade for wood		2 pack	8tpi	75mm
SRBU36T-2	STARRETT	Bi-Metal jigsaw blade for wood		2 pack	6tpi	75mm
SRBU310T-2	STARRETT	Bi-Metal jigsaw blade for wood		2 pack	10tpi	75mm
SRBU310DT-2	STARRETT	Bi-Metal jigsaw blade for wood		2 pack	10tpi	75mm
SRBU3DC-2	STARRETT	Bi-Metal jigsaw blades for wood		2 pack	9-19tpi	75mm
SRBU418-2	STARRETT	Bi-Metal jigsaw blade for wood/metal		2 pack	18tpi	100mm
SRBU424-2	STARRETT	Bi-Metal jigsaw blade for metal		2 pack	24tpi	100mm
SRBU41014-2	STARRETT	Vari. Pitch Bi-Metal jigsaw blade for wood/metal		2 pack	10/14tpi	100mm
SRBU1	STARRETT	Jigsaw blade set - assorted sizes		5pack	6-14tpi	
SRBU4	STARRETT	Jigsaw blade set - assorted sizes		14pack	6-32tpi	
GFB251	GFB	Fine cut for metal		3 pack	36tpi	75mm
GFB252	GFB	Medium cut for metal		3 pack	21tpi	75mm
GFB253	GFB	Scroll cut for wood		3 pack	12tpi	75mm
GFB254	GFB	Coarse cut for wood		3 pack	6tpi	100mm
GFB255	GFB	Taper ground for wood		3 pack	10tpi	100mm
GFB256	GFB	Taper ground for wood		3 pack	6tpi	100mm
GFB205	GFB	All woods, compositions, plastic, plywood		3 pack	6tpi	125mm
PLANER BLADES and ADAPTORS:						length
TWPB82	STANWAY	Tungsten carbide planer blade adaptor kit				82mm
TWPB82-2	STANWAY	Tungsten carbide planer blade - 2 pack				82mm

WOOD CUTTING



SRBU36 - 6tpi x 75mm



SRBU36T - 6tpi x 75mm



SRBU38 - 8tpi x 75mm



SRBU310T - 10tpi x 75mm



SRBU310DT - 10tpi x 75mm Reverse



SRBU3DC - 9-19tpi x 75mm Dual Cut

MULTI-PURPOSE



SRBU214 - 14tpi x 50mm



SRBU214S - 14tpi x 50mm



SRBU41014 - 10/14tpi x 100mm



SRBU218 - 18tpi x 50mm



SRBU418 - 18tpi x 100mm

METAL CUTTING



SRBU424 - 24tpi x 100mm



SRBU232 - 32tpi x 50mm



SRBU1
5pc jigsaw blade kit



SRBU4
14pc jigsaw blade kit



TWPB82-2
82mm blades



TWPB82
Planer blade adaptor kit

GFB JIGSAW BLADES



GFB251
36tpi



GFB252
24tpi



GFB253
12tpi



GFB254
6tpi



GFB255
10tpi



GFB256
6tpi



GFB205
6tpi



GFB258
21tpi



GFB259
12tpi



GFB260
6tpi



GFB261
10tpi



GFB262
6tpi

81					
TUNGSTEN TIPPED SAW BLADES – STANWAY ENDURO SERIES:				Diameter	bore size
TWT185X24T20	STANWAY	Enduro series – 24 teeth		185mm	16–20mm
TWT185X40T20	STANWAY	Enduro series – 40 teeth		185mm	16–20mm
TWT210X24T25	STANWAY	Enduro series – 24 teeth		210mm	16–25mm
TWT210X40T25	STANWAY	Enduro series – 40 teeth		210mm	16–25mm
TWT235X20T25	STANWAY	Enduro series – 20 teeth		235mm	16–25mm
TWT235X40T25	STANWAY	Enduro series – 40 teeth		235mm	16–25mm
TWT250X40T25	STANWAY	Enduro series – 40 teeth		250mm	16–25mm
TUNGSTEN TIPPED SAW BLADES – STANWAY PROFESSIONAL SERIES:				Diameter	bore size
TWT185–20	STANWAY	Pro series – Tungsten carbide – 24 teeth		185mm	16–20mm
TWT210–25	STANWAY	Pro series – Tungsten carbide – 24 teeth		210mm	16–25mm
TWT235–25	STANWAY	Pro series – Tungsten carbide – 30 teeth		235mm	16–25mm
TWT185–SET3	STANWAY	Pro series set – Tungsten carbide – 16–24–40 teeth		185mm	16–20mm
TWT210–SET3	STANWAY	Pro series set – Tungsten carbide – 18–24–32 teeth		210mm	16–25mm
DIAMOND SAW BLADES:				Diameter	bore size
DRDBCR110	DRAPER	CONTINUOUS RIM DIAMOND BLADE – 7/8" bore		110mm	22.23mm
DRDBCR115	DRAPER	CONTINUOUS RIM DIAMOND BLADE – 7/8" bore		115mm	22.23mm
DRDBSR115	DRAPER	SEGMENTED RIM DIAMOND BLADE – 7/8" bore		115mm	22.23mm
DRDBSR125	DRAPER	SEGMENTED RIM DIAMOND BLADE – 7/8" bore		125mm	22.23mm
DRDBTR115	DRAPER	TURBO RIM DIAMOND BLADE – 7/8" bore		115mm	22.23mm
DRDBTR125	DRAPER	TURBO RIM DIAMOND BLADE – 7/8" bore		125mm	22.23mm
DRDBSET3	DRAPER	Diamond Blade Set – Continuous, Segmented, Turbo		115mm	22.23mm
MULTIBLADES – VARIOUS				Length	Width
GM450–35	G–MAN	HCS GM Multiblade <i>For cutting wood & PVC</i>		50mm	35mm
GM451–10	G–MAN	Bi–Metal GM Multiblade <i>For cutting wood w nails, metal, PVC & drywall</i>		30mm	10mm
GM453–44	G–MAN	Bi–Metal GM Multiblade <i>For cutting wood w nails, metal, PVC & drywall</i>		55mm	44mm
GM454–65	G–MAN	HCS GM Multiblade <i>For cutting wood & PVC</i>		50mm	65mm
GM456–30	G–MAN	Bi–Metal GM Multiblade <i>For cutting sheetmetal, wood & fibreglass</i>		50mm	30mm



TWT185-20
24t x 185mm



TWT210-25
24t x 210mm



TWT235-25
30t x 235mm



TWT185X24T20
24t x 185mm Enduro



TWT185X40T20
40t x 185mm Enduro



TWT210X24T25
24t x 210mm
Enduro



TWT210X40T25
40t x 210mm
Enduro



TWT235X20T25
20t x 235mm
Enduro



TWT235X40T25
40t x 235mm
Enduro



TWT250X40T25
40t x 250mm
Enduro



TWT210-SET3
210mm set of 3 blades
18t, 24t, 32t



TWT185-SET3
185mm set of 3 blades
16t, 24t, 40t



DRDBC115
Continuous rim
diamond blade



DRDBTR115
Turbo rim diamond
blade



DRDBSR115
Segmented rim
diamond blade



DRDBSET3
115mm Diamond
Blade Set



GM450-35
HCS GM multiblade
- 50mm x 35mm



GM451-10
Bi-metal GM multiblade
- 30mm x 10mm



GM453-44
Bi-metal GM multiblade
- 55mm x 44mm



GM454-65
HCS GM multiblade
- 50mm x 65mm



GM456-30
Bi-metal GM multiblade
- 50mm x 30mm

HACKSAWS:

MRHF04	MORSE	Flush cutting hacksaw - rectangular alloy section	300mm
GM3000-01	G-MAN	Ergonomic soft grip professional hacksaw frame	300mm
SRN145	STARRETT	Flush cutting hacksaw - With rubber grip	300mm
GM3000-10	G-MAN	Junior hacksaw - wire frame	150mm
GM3000-12	G-MAN	Junior hacksaw - ergonomic handle	150mm
ST20-807	STANLEY	Mini hacksaw - plastic frame	
KW440	KANZAWA	Handy hacksaw - metal handle	

HACKSAW BLADES:
teeth/inch
length

			teeth/inch	length
MRHB18	MORSE	Bi-metal hacksaw blade	18tpi	300mm
MRHB18-C	MORSE	Bi-metal hacksaw blade -card of 2	18tpi	300mm
MRHB24	MORSE	Bi-metal hacksaw blade	24tpi	300mm
MRHB24-C	MORSE	Bi-metal hacksaw blade - card of 2	24tpi	300mm
MRHB32	MORSE	Bi-metal hacksaw blade	32tpi	300mm
MRHB32-C	MORSE	Bi-metal hacksaw blade - card of 2	32tpi	300mm
PNHB18	EVACUT	Bi-metal hacksaw blade	18tpi	300mm
PNHB24	EVACUT	Bi-metal hacksaw blade	24tpi	300mm
PNHB32	EVACUT	Bi-metal hacksaw blade	32tpi	300mm
PNHS18	EVACUT	High speed steel hacksaw blade	18tpi	300mm
PNHS24	EVACUT	High speed steel hacksaw blade	24tpi	300mm
PNHS32	EVACUT	High speed steel hacksaw blade	32tpi	300mm
SRBS1218	STARRETT	Bi-metal hacksaw blade	18tpi	300mm
SRBS1224	STARRETT	Bi-metal hacksaw blade	24tpi	300mm
SRBS1232	STARRETT	Bi-metal hacksaw blade	32tpi	300mm
SRRS1224	STARRETT	High speed steel hacksaw blade	24tpi	300mm
SRRS1232	STARRETT	High speed steel hacksaw blade	32tpi	300mm
GM3011-32	G-MAN	Junior hacksaw blade - pack of 10	32tpi	150mm



MRHF04
300mm Hacksaw



GM3000-10
150mm Junior hacksaw



GM3000-01
300mm Hacksaw



GM3000-12
150mm Junior hacksaw



SRN145
300mm Hacksaw



FT320-0044
Mini hacksaw



KW440
Handy hacksaw



MRHB24
24 tpi Bi-metal hacksaw blade



ST20-807
Mini hacksaw

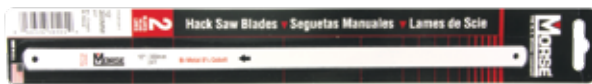

MRHB24-C
24t 2pk Bi-metal hacksaw blades



SRBS1224
24 tpi Bi-metal hacksaw blade



PNHB24
24 tpi Bi-metal hacksaw blade



SRRS1224
24 tpi HSS hacksaw blade



PNHS24
24 tpi HSS hacksaw blade



GM3011-32
150mm Junior hacksaw blade

BACKSAW (TENON) SAWS:			length	points/inch
GM153H14	G-MAN	Backsaw (Tenon) saw - orange plastic handle	350mm	13pt
DRDTS250	DRAPER	Dovetail saw - Soft grip handle	250mm	10pt
HARD POINT HAND SAWS:				
GM328H18	G-MAN	Panel saw - hard point	450mm	7pt
ST15-289	STANLEY	Jetcut (Panel) saw - hard point saw	550mm	8pt
GM328H22	G-MAN	Panel saw - hard point	550mm	7pt
GM252H18	G-MAN	Laminate saw - hard point	450mm	7pt
GM260H24	G-MAN	(Plaster) Board saw - hard point	600mm	GT Tooth
GM255H22	G-MAN	Insulation cutting hand saw	550mm	wave
GM167H28	G-MAN	Concrete cutting hand saw	710mm	
GM229H22	G-MAN	Procut panel saw - hard point	550mm	9pt
GM327H22	G-MAN	XT panel saw - hard point	550mm	9pt
GM301H14	G-MAN	Hand saw mini - hard point	355mm	13pt
GM275H15	G-MAN	Toolbox saw - hard point	375mm	13pt
GM229H16	G-MAN	Toolbox saw - hard point	400mm	9pt
WOOD CUTTING SAWS - SUNDRY:				teeth/inch
DRCSF	DRAPER	Coping saw frame		
ST15-104	STANLEY	Coping saw frame		
DRXCSB	DRAPER	Coping saw blades		15tpi
ST15-061	STANLEY	Coping saw blades		15tpi
DRX19316	DRAPER	Fretsaw blades for DRFSF-295 - 10 pack		
WALLBOARD SAWS:				
KW420-150	KANZAWA	Wallboard saw - self drilling point	150mm	
ST15-206	STANLEY	Wallboard saw - self starting point	152mm	9tpi
KWX420-150	KANZAWA	Wallboard saw blade - self drilling point	150mm	
UNIVERSAL SAWS AND CUTTER:				
ST20-556	STANLEY	Fatmax Jab saw	152mm	
MRJABSAW	MORSE	Jab saw	150mm	
HUJSAW125	FISCO	Jab saw	125mm	



MRJABSAW
150mm Jabsaw



HUJSAW125
125mm Jabsaw



ST15-104
Coping saw



ST15-061
Coping saw blades



ST20-556
152mm Jab saw



ST15-206
152mm Jab saw



DRCSF
Coping saw



DRXCSB
Coping saw blades



KW420-150
Wallboard saw



DRDTS250
Dovetail saw



ST15-289
550mm Jetcut saw



GM328H18
450mm Panel saw



GM328H22
550mm Panel saw



GM229H16
300mm Tool box saw



GM153H14
350mm Tenon saw (backsaw)



GM252H18
450mm Laminate saw



GM275H15
375mm Tool box saw



GM255H22
550mm Insulation saw



GM229H22
550mm Rapid panel saw



GM327H22
550mm FX panel saw



GM260H24
600mm (Plaster) Board saw



GM167H28
710mm Concrete cutting saw

AVIATION SNIPS:				colour code	length
MW6716-L	MIDWEST	Right hand - LEFT cut and straight		Red	245mm
MW6716-R	MIDWEST	Left hand - RIGHT cut and straight		Green	245mm
MW6716-S	MIDWEST	Universal snip - cuts straight and wide curves		Yellow	245mm
MW6716-SET3	MIDWEST	Combo set - Standard left, right and straight - Set of 3			245mm
MW6716-A	MIDWEST	Straight long cut aviation snip			288mm
CH6716-L	CHANNELLOCK	Right hand - LEFT cut and straight		Red	245mm
CH6716-R	CHANNELLOCK	Left hand - RIGHT cut and straight		Green	245mm
CH6716-S	CHANNELLOCK	Universal snip - cuts straight and wide curves		Yellow	245mm
FT315-7801	FULLER	Right hand - LEFT cut and straight		Red	250mm
FT315-7803	FULLER	Left hand - RIGHT cut and straight		Green	250mm
FT315-7802	FULLER	Universal snip - cuts straight and wide curves		Yellow	250mm
ST14-562	STANLEY	Left cut aviation snip - cuts 23g stainless steel		red	305mm
ST14-563	STANLEY	Straight aviation snip - cuts 23g stainless steel		yellow	305mm
ST14-564	STANLEY	Right cut aviation snip - cuts 23g stainless steel		Green	305mm
UPRIGHT AVIATION SNIPS:				colour code	length
MW6900-L	MIDWEST	Upright aviation snip - cuts left curves and straight		Red	205mm
MW6900-R	MIDWEST	Upright aviation snip - cuts right curves and straight		Green	205mm
OFFSET AVIATION SNIPS:				colour code	length
MW6510-L	MIDWEST	Right hand - LEFT cut and straight		Red	245mm
MW6510-R	MIDWEST	Left hand - RIGHT cut and straight		Green	245mm
MW6510-S	MIDWEST	Offset snip - cuts straight and wide curves		Yellow	245mm
MW6510-SET2	MIDWEST	Offset snips set of 2 - left and right			245mm
CH6510-L	CHANNELLOCK	Right hand - LEFT cut and straight		Red	245mm
CH6510-R	CHANNELLOCK	Left hand - RIGHT cut and straight		Green	245mm
ST14-568	STANLEY	Left hand - Right cut aviation snip		Green	239mm
UNIVERSAL SNIPS / MULTI PURPOSE SCISSORS					length
OLSCS2	OLFA	Serrated multi purpose scissors			173mm
SHEET METAL NIBBLERS:					capacity
EDM172	EDMA	Nibblex Super metal cutting attachment		sheet metal	up to 1.2mm



ST14-563
Stainless steel cut Aviation snips



ST14-564
Stainless steel cut Aviation snips



ST14-562
Stainless steel cut Aviation snips



CH6716-S
Straight Aviation snips



CH6716-R
Right cut Aviation snips



CH6716-L
Left cut Aviation snips



CH6510-R
Offset Right cut Aviation snips



CH6510-L
Offset Left cut Aviation snips



MW6716-SET3
Aviation snip set



MW6510-SET2
Offset Aviation snip set



ST14-568
Offset Right cut Aviation snips



MW6716-L
Right hand Aviation snips



MW6716-R
Left hand Aviation snips



MW6716-S
Universal Aviation snips



MW6510-L
Right hand Offset Aviation snips



MW6510-R
Left hand Offset Aviation snips



MW6510-S
Universal Offset Aviation snips



MW6900-R
Right curve Upright snips



MW6900-L
Left curve Upright snips



MW6716-A
288mm Long cut aviation snips



EDM172
Nibbler metal cutting attachment



OLSCS2
Serated multi purpose scissors

TIN SNIPS:
length

G245-200	GILBOW	English pattern general purpose snips - straight blades	200mm
G245-250	GILBOW	English pattern general purpose snips - straight blades	250mm
G245-300	GILBOW	English pattern general purpose snips - straight blades	300mm
MWP77-D	MIDWEST	Duckbill Tinner Snip	175mm

JEWELLERS SNIPS:

G56	GILBOW	Jewellers snips - straight blades	175mm
-----	--------	-----------------------------------	-------

HAND/MECHANICAL SHEARS:

MO-TSHD	MALCO	Turbo Shear - Heavy Duty
MOX-TS1RB	MALCO	Turbo Shear Replacement Blade - Regular
MOX-TSHDRB	MALCO	Turbo Shear Replacement Blade - Heavy Duty

SNIPS AND SHEARS - SPARE PARTS:

MWX2210-L	MIDWEST	Replacement blade for MW2110-L
MWX2110-R	MIDWEST	Replacement blade for MW2110-R
MWX-M1200R	MIDWEST	Replacement blade for MWM1200L

SHEET METAL CRIMPING TOOLS:
crimp length
length

MWC5	MIDWEST	5-Blade Duct Crimper	41.3mm	267mm
MO-SG10	MALCO	Straight Seamer & Tong with Grip Jaw		235mm
MO-SG11	MALCO	Offset Seamer & Tong with Grip Jaw		235mm



G56
175mm Straight blade Jewellers snips



G245-200
200mm Tin snips



G245-250
250mm Tin snips



G245-300
300mm Tin snips



MO-SG11
Offset Seamer & Tong with Grip Jaw



MO-SG10
Straight Seamer & Tong with Grip Jaw



MWC5
5-Blade Duct Crimper



MO-TSHD
Turbo shear

FOLDING RULES:
grad side 1
grad side 2

TW59W-18	STANWAY	1m Bevel edge 4-fold carpenters rule - White ABS	5mm/mm	mm/5mm
HU59W-18	FISCO	1m Bevel edge 4-fold carpenters rule - White nylon	5mm/mm	mm/5mm
HU64W-18	FISCO	1m/36" Bevel edge 4-fold carpenters rule - White nylon	5mm/mm	inch/16ths
HU59Y-16	FISCO	1m Square edge 4-fold carpenters rule - Yellow ABS	5mm/mm	mm/5mm

STAINLESS STEEL RULES:
blade length
blade width

TWR150SS	STANWAY	Stainless steel rule - metric	150mm/6"	15mm
TL150B	TOLEDO	Stainless steel rule - graduated two sides	150mm/6"	15mm
TWR300SS	STANWAY	Stainless steel rule - metric	300mm/12"	25mm
TL300	TOLEDO	Stainless steel rule - graduated two sides	300mm/12"	25mm
TL600	TOLEDO	Stainless steel rule - graduated two sides	600mm/24"	30mm
TWR1000SS	STANWAY	Stainless steel rule - metric	1000mm/36"	30mm
TL1000	TOLEDO	Stainless steel rule - graduated two sides	1000mm/36"	30mm

STRAIGHT EDGES:

SWSVE121	SAVAGE	No-slip aluminium straight edge - metric scales		1200mm
SWSVE183	SAVAGE	No-slip aluminium straight edge - metric scales		1800mm
SWSVE244	SAVAGE	No-slip aluminium straight edge - metric scales		2400mm

SUNDRY RULES:

ST35-333	STANLEY	Line of chords and circumference rule	600mm	19mm
GN16	GENERAL	Multiuse rule and gauge		
DRATR-300	DRAPER	Aluminium Triangle scale rule	300mm	



HU64W-18
Imperial 4-fold rule

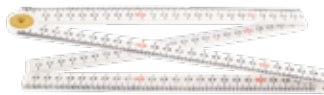

HU59W-18
Metric 4-fold rule



HU59Y-16
Imperial 4-fold rule

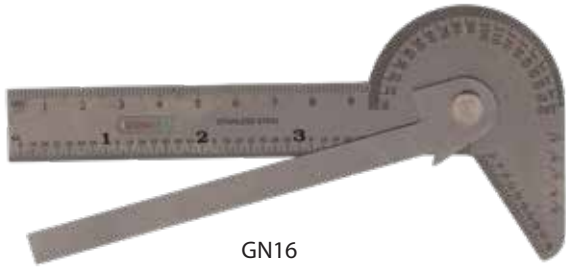

GN16
Rule and gauge



DRATR-300
Aluminium tri-scale rule



ST35-333
Line of chords rule

STEEL RULES



TL150B
150mm



TL300
300mm



TL600
600mm



TL1000
1000mm



TWR150SS
150mm



TWR300SS
300mm



TWR1000SS
1000mm



SWSVE121
1.2m straight edge

COMPASSES AND DIVIDERS:

GN523	GENERAL	Adjustable Trammel Point Set (1 Pair)
DRE50-150	DRAPER	150mm Spring dividers

CALIPERS:
Length

SL202-105	SCALA	Vernier caliper with Roller Adjustment - Metric/Imperial Readings	125mm / 5"
DRVC-150	DRAPER	Vernier caliper with Roller Adjustment - Metric/Imperial Readings	150mm / 6"

BEVELS:
Blade Length

SW780-200	SHINWA	Sliding bevel - all metal with end screw lock	200mm
SW780-250	SHINWA	Sliding bevel - all metal with end screw lock	250mm
FP1254-225	FOOTPRINT	Sliding bevel - beechwood with wing nut lock	225mm
SRK15N	STARRETT	Sliding bevel - plastic handle	200mm

MARKING / MORTICE GAUGES:

FP1258	FOOTPRINT	Marking gauge - beechwood
FP1876	FOOTPRINT	Mortice gauge - beechwood with double pins
FPX1258-01	FOOTPRINT	Gauge Thumbscrew for FP1258 / FP1876

FEELER GAUGES:
Length

DRFG-10F	DRAPER	10 Blade Imperial Feeler Gauge Set <i>Sizes: 0.0015, 0.002, 0.003, 0.004, 0.006, 0.008, 0.010, 0.012, 0.015, 0.025 inch</i>	100mm
DRFG-10M	DRAPER	10 Blade Metric Feeler Gauge Set <i>Sizes: 0.05, 0.1, 0.15, 0.2, 0.3, 0.4, 0.5, 0.6, 0.7, 0.8mm</i>	100mm

SUNDRY GAUGES:

GN16	GENERAL	Stainless Steel Rule & Gauge
GN18	GENERAL	Protractor - round head
SR505P-7	STARRETT	Mitre Protractor
GN837	GENERAL	Profile gauge - stainless steel pins
SWAF006M	SWANSON	Magnetic Angle Finder

STAIR GAUGES:

SWSG0020	SWANSON	Brass Stair Gauges - Pair
----------	---------	---------------------------



GN523
Adjustable Trammel Point Set



SL202-105
125mm Vernier caliper



DRVC-150
150mm Vernier caliper



DRE50-150
Spring dividers



SW780-200
200mm Sliding bevel
All metal



FP1254-225
225mm Sliding bevel
Beechwood handle



SRK15N
200mm Sliding bevel
Plastic handle with vial



FP1258
Marking gauge



FP1876
Mortice gauge



FPX1258-01
Gauge Thumbscrew



DRFG-10F
Feeler Gauge Set
10 Blades (Imperial)

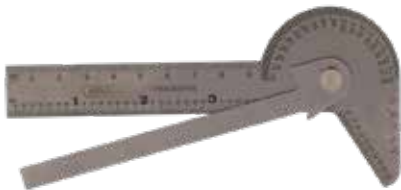

GN16
Stainless Steel Rule & Gauge



GN18
Protractor - round head



SR505P-7
Mitre Protractor



GN837
Profile gauge



SWAF006M
Magnetic Angle Finder



SWSG0020
Brass Stair Gauges
(1 pair)

COMBINATION SQUARES: size

SWTC130M	SWANSON	Cast Zinc Head (Metric)	150mm
SWTC130	SWANSON	Cast Zinc Head (Metric/Imperial)	150mm/6"
FS56	FISCO	Cast Zinc Head (Metric/Imperial)	150mm/6"
FS58	FISCO	Cast Zinc Head (Metric) <i>with Centre Head & Protractor</i>	300mm
SWSVCM233	SAVAGE	Aluminium Head (Metric)	300mm
SWTC132M	SWANSON	Cast Zinc Head (Metric)	300mm
ST46-143	STANLEY	Die Cast Head (Metric)	300mm
ST46-028	STANLEY	Die Cast Head (Metric/Imperial)	300mm/12"
ST46-151	STANLEY	Cast Iron Head (Metric/Imperial)	300mm/12"
SWSVCM433	SAVAGE	Aluminium Head (Metric)	400mm
SWTC134M	SWANSON	Cast Zinc Head (Metric)	400mm
SWTC134	SWANSON	Cast Zinc Head (Metric/Imperial)	400mm/16"
SWX233-01	SWANSON	Replacement Spring, Screw and Nut	
SWX233-P	SWANSON	Replacement Scriber Pin	

TRY SQUARES: Size:

FP1247-150	FOOTPRINT	Try square - walnut stock	150mm
FP1247-225	FOOTPRINT	Try square - walnut stock	225mm
FP1247-263	FOOTPRINT	Try square - walnut stock	263mm
SRK53M-200	STARRETT	Try square - stainless steel	200mm
SRK53M-250	STARRETT	Try square - stainless steel	250mm
JN1940-0800	JOHNSON	Try square - Bamboo handle, stainless blade	200mm
JN1958-0200	JOHNSON	Try and mitre square - aluminium	200mm

ENGINEERS SQUARES: Size:

DRESQ-150	DRAPER	Engineers square	150mm
-----------	--------	------------------	-------

CARPENTERS RAFTER SQUARES: Size:

TWCS13	STANWAY	Metric carpenters square - Steel	600mm x 400mm
ST45-530	STANLEY	Carpenters square - with metric tables	600mm x 400mm
HNK-M003	HNK	Mini rafter square	300mm x 200mm

ANGLE SQUARES: Size:

TWJS1956	STANWAY	Rafter/Angle square with rafter scales - Aluminium	180mm x 180mm
TWJS300	STANWAY	Rafter/Angle square with rafter scales - Aluminium	300mm x 300mm
ST46-060	STANLEY	Quick angle square - ABS plastic	185mm
SWT0118	SWANSON	High Visibility Speedlite® Square	200mm
HNK-M004	HNK	Angle rafter square	185mm x 185mm



FS56
150mm/6"



SWTC130
150mm/6"



SWTC130M
150mm

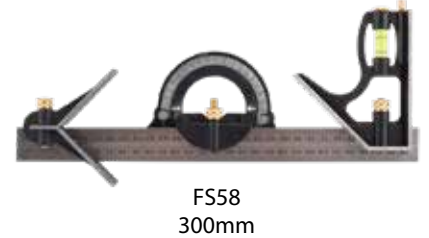

FS58
300mm



SWSVCM233
300mm

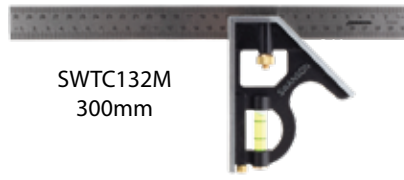

SWTC132M
300mm



ST46-143
300mm

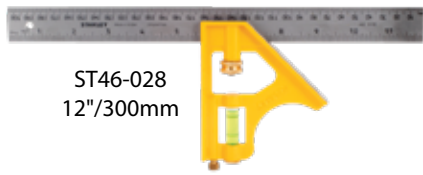

ST46-028
12"/300mm

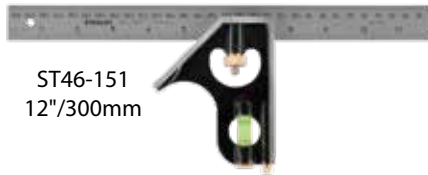

ST46-151
12"/300mm



SWSVCM433
400mm

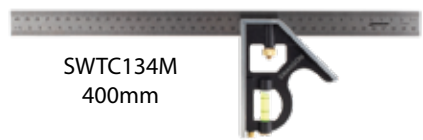

SWTC134M
400mm



SWTC134
400mm/16"



DRESQ-150
Engineers Square



FP1247-263
Try Square



SRK53M-250
Try Square



JN1940-0800
Try square

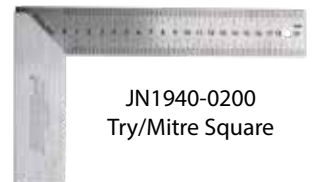

JN1940-0200
Try/Mitre Square

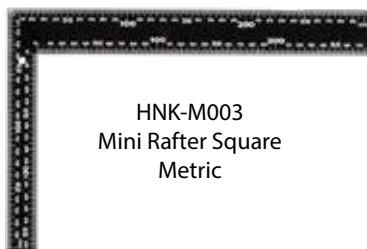

HNK-M003
Mini Rafter Square
Metric

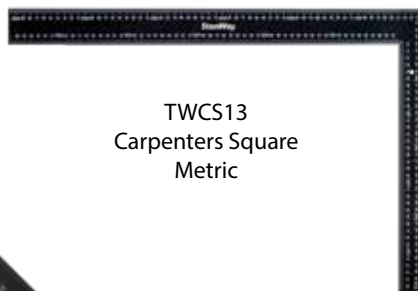

TWCS13
Carpenters Square
Metric



ST45-530
Carpenters Square
Metric

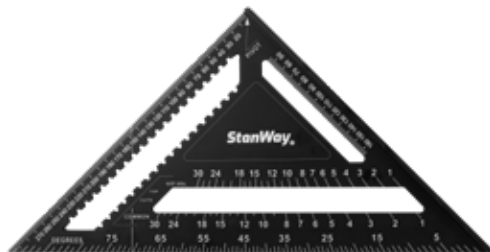

TWJS300
Rafter/Angle Square



TWJS1956
Rafter/Angle Square



ST46-060
Quick Angle Square



SWT0118
Speedlite® Square

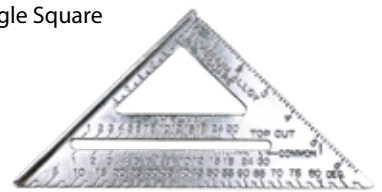

HNK-M004
Rafter/Angle Square

FIBREGLASS TAPES:
blade length
blade width

YOTR30	YAMAYO	Fibreglass tape - Open ABS reel	30m	12.7mm
YOTR50	YAMAYO	Fibreglass tape - Open ABS reel	50m	12.7mm
YOTR100	YAMAYO	Fibreglass tape - Open ABS reel	100m	12.7mm
DRFGMT020M	DRAPER	Long fibreglass tape	20m	
DRFGMT030M	DRAPER	Long fibreglass tape	30m	
FS-FT30	FISCO	Fibreglass tape - Ergonomic ABS case	30m	12.7mm
DRFGST030M	DRAPER	Fibreglass long surveyors tape	30m	13mm
DRFGST050M	DRAPER	Fibreglass long surveyors tape	50m	13mm
DRFGST100M	DRAPER	Fibreglass long surveyors tape	100m	13mm
YMSR50	YAMAYO	Surveyors rope	50m	6mm
YMSR100	YAMAYO	Surveyors rope	100m	6mm

LONG STEEL TAPES:

ST34-138	STANLEY	Fatmax Long Steel Tape	30m	9.5mm
TWD30M	STANWAY	Long steel tape - Impact resistance ABS case	30m	13mm
FS20SME	FISCO	Long steel tape - Impact resistant ABS case	20m/66ft	10mm
FS30SME	FISCO	Long steel tape - Impact resistant ABS case	30m/100ft	10mm
FS50P	FISCO	Long steel tape - Open ABS reel	50m	13mm
FS100P	FISCO	Long steel tape - Open ABS reel	100m	13mm

NYLON COATED STEEL TAPES:

FS-PY50	FISCO	Nylon coated steel tape - Open ABS reel	50m	13mm
YNR30	YAMAYO	Nylon coated steel tape - Open ABS reel	30m	10mm
YNR50	YAMAYO	Nylon coated steel tape - Open ABS reel	50m	10mm
YNR100	YAMAYO	Nylon coated steel tape - Open ABS reel	100m	10mm

WALKING MEASURES:
Max Distance

KSRR10M	KESON	Single Wheel Measuring Wheel	9999.9m	100mm
JN1 826-2004	JOHNSON	Double Wheel Measuring Wheel	9999.9m	100mm
KSRR3M	KESON	Contractor Grade Measuring Wheel	9999.9m	318mm
KSRRT12M	KESON	Foldable Long-Run Measuring Wheel	9999.9m	318mm

DIAMETER TAPES:

YD3M	YAMAYO	Fibreglass Diameter tape-measures to 3m dia	10m	12.5mm
------	--------	---	-----	--------



YNR30
30m x 10mm
Nylon coated steel blade



YNR50
50m x 10mm
Nylon coated steel blade



YNR100
100m x 10mm
Nylon coated steel blade



KSRR12M
318mm x 9,999.9m
Measuring Wheel



KSRR3M
318mm x 9,999.9m
Measuring Wheel



YOTR30
30m x 12.7mm
fibreglass blade



YOTR50
50m x 12.7mm
fibreglass blade



YOTR100
100m x 12.7mm
fibreglass blade



YMSR50
50m Measurement
rope



FS50P
50m x 13mm
Steel blade



FS-PY50
50m x 13mm
nylon coated steel blade



FS100P
100m x 13mm
Steel blade



KSRR10M
100mm x 9,999.9m
Measuring Wheel



DRFGMT020M
20m long fibreglass blade



DRFGST030M
30m x 13mm
Fibreglass



DRFGST050M
50m x 13mm
Fibreglass



DRFGST100M
100m x 13mm
Fibreglass



DRFGMT030M
30m long fibreglass blade



TWD30M
30m x 13mm
steel blade



FS30SME
30m/100ft x 10mm
steel blade



FS-FT30
30m x 12.7mm
fibreglass blade



YD3M
10m Diameter tape



ST34-138
Fatmax steel blade 30m

POCKET TAPES:
blade length blade width

FSTUM3M	FISCO	Uni-matic ABS case - matt yellow blade	3m	16mm
FSTL3M	FISCO	Tri-Lok ABS case - matt yellow blade	3m	13mm
FSTL5M	FISCO	Tri-Lok ABS case - matt yellow blade	5m	19mm
ST30-497L	STANLEY	Tylon™ blade coating - yellow blade	5m	19mm

POWER TAPES:

FSBT8M	FISCO	Big-T ABS case - matt yellow blade	8m	25mm
FSTL8M	FISCO	Tri-Lok ABS case - matt yellow blade	8m	25mm
FSTL10M	FISCO	Tri-Lok ABS case - matt yellow blade	10m	25mm
ST33-869	STANLEY	Fatmax Blade magnetic end builders tape	8m	25mm
TWF8M	STANWAY	Fluorescent coloured case	8m	25mm
STHT30139	STANLEY	Yellow case Builders tape	8m	25mm
TWP825	STANWAY	Professional Builders tape	8m	25mm
TW-TBC8025	STANWAY	Professional Builders tape - <i>Customized Branding</i>	8m	25mm
ST30-393	STANLEY	Tylon metric builders tape	8m	25mm
TWP832	STANWAY	Professional Builders tape	8m	32mm
ST33-731	STANLEY	Fatmax Blade Armour builders tape	8m/26ft	32mm
ST33-732	STANLEY	Fatmax Blade Armour builders tape	8m	32mm
STFMHT38219	STANLEY	Fatmax Extreme builders tape	8m	32mm
ST33-829	STANLEY	Fatmax Blade Armor tape	10m	32mm



FSTUM3M
3m Uni-matic



FSTL3M
3m Tri-Lok



FSTL5M
5m Tri-Lok



FSBT8M
8m Big-T



FSTL8M
8m Tri-Lok



FSTL10M
10m Tri-Lok



ST33-869
8m Magnetic builders tape



TWF8M
8m Fluorescent



STHT30139
8m Builders tape



TWP825
8m Grip Gear



TWP832
8m Wide Blade



ST33-731
8m Blade Armour



ST33-732
8m Blade Armour



ST30-393
8m Tylon Tape Measure



ST33-829
Blade Armor builders tape 10m



ST30-497L
5m builders tape



STFMHT38219
8m Xtreme Tape Measure

TOOL BELTS / APRONS:
Material

LR420	TAURUS	Electrician's Tool Apron <i>Pockets: 8 Slots, Tape Roll Chain</i>	Leather
LREB409C-R	TAURUS	Classic Electrician's Tool Belt (Right Handed Design) <i>Pockets: 1 Large, 8 Small, Voltage Tester Pocket, Tape Roll Chain Tape Clip</i>	Leather
LR312	TAURUS	Carpenters Tool Apron <i>Pockets: 3 Large, 3 Small, Tape Clip, Combination Square Holder 2 Hammer Loops</i>	Suede
LR314	TAURUS	Split Leg Tool Apron <i>Pockets: 4 Large, 3 Small, Tape Clip, Combination Square Holder 2 Hammer Loops</i>	Suede
LRAC13R	TAURUS	'Traditional' Split Leg Tool Apron <i>Pockets: 4 Large, 3 Small, Tape Clip, Combination Square Holder 2 Hammer Loops</i>	Suede / Leather
TWWG314	BUILD PRO	Split Leg Tool Apron <i>Pockets: 4 Large, 7 Small, Nail Bar Holder, Tape Clip, Combination Square Holder, Interchangeable Hammer Holder</i>	Suede / Leather
TWWG31010	BUILD PRO	'Kakadu' Tool Apron <i>Pockets: 4 Large, 6 Small, Tape Pouch, Interchangeable Chisel Holder, Interchangeable Hammer Holder</i>	Suede / Leather
JKB-002	JACKMAN	Tool Pouch and Belt <i>Pockets: 2 Large, 2 Medium, 10 Small, 8 Inside, Tape Clip 2 Hammer Loops</i>	PVC-Coated Polyester
TWWGGLAD	BUILD PRO	'Gladiator' Tool Belt <i>Pockets: 4 Large, 13 Small, Center Pouch, Tape Clip, Nail Bar Holder, Nail Gun Loop, Hammer Holder, Combination Square Holder, Chisel Holder, Water Bottle Holder, Phone Pouch</i>	Suede / Leather

NAIL BAGS:

TWWGNB0T10	BUILD PRO	Nail Bag <i>Pockets: 4 Large, 6 Small, 2 Hammer Holders</i>	Oil Tanned Leather
TWWGLBNBS1B	BUILD PRO	'Noosa' Leather Nail Bag <i>Pockets: 2 Large, 1 Medium, 3 Small/Pen Pockets, Tape Clip</i>	Black Nubuck Leather

TOOL HOLDERS / FROGS:

TWWGLBAL5805	BUILD PRO	Detachable Tool Lanyard with Carabiner	Up to Max. Capacity of 1.2m & 3kg
TWWGLBAL5806	BUILD PRO	Fixed Tool Lanyard with Carabiner	Up to Max. Capacity of 1.2m & 3kg
TWWGLBFCHN	BUILD PRO	Combined Chisel & Wire Cutter Holder	
TWWGLBFHNFS	BUILD PRO	Combined Chisel & Wire Cutter Holder	
TWWGLBFCSD	BUILD PRO	Double Chisel Holder	
TWWGLBFLRP	BUILD PRO	Straight Level & Ruler Holder	
TWWGLBFNGH	BUILD PRO	Nail Gun Holder	
TWWGLBFSQH	BUILD PRO	Square Holder	
TWWGLBFTC	BUILD PRO	Tape Clip Holder	
TWWGLBFPHF	BUILD PRO	Claw Hammer Holder	
DRSHL	DRAPER	Swivelling Hammer Holder	



LREB409C-R
Classic Electrician's Tool Belt



LR420
Electrician's Tool Belt



LR312
Carpenters Tool Apron



LR314
Split Leg Tool Apron



JKB-002
Tool Pouch and Belt



TWWGGLAD
'Gladiator' Tool Belt



TWWG314
Split Leg Tool Apron



TWWG31010
'Kakadu' Tool Apron



LRAC13R
Traditional Split Leg Tool Apron



TWWGNBOT10
Oil Tanned Leather Nail Bag



TWWGLBNBS1B
'Noosa' Leather Nail Bag



TWWGLBAL5806
Fixed Tool Lanyard



TWWGLBAL5805
Detachable Tool Lanyard



TWWGLBFCHN
Combined Chisel &
Wire Cutter Holder



TWWGLBFHNFS
Combined Chisel &
Wire Cutter Holder



TWWGLBFCSDD
Double Chisel
Holder



TWWGLBFLRP
Straight Level &
Ruler Holder



TWWGLBFNGH
Nail Gun Holder



TWWGLBFSQH
Square Holder



TWWGLBFTC
Tape Clip Holder



TWWGLBFPFH
Claw Hammer
Holder



DRSHL
Swivelling
Hammer Holder

BELTS AND SUSPENDERS:

DRHDB	DRAPER	Adjustable Shoulder Brace (Black)
TWWGHAY	BUILD PRO	Adjustable Padded Shoulder Brace (Hi-Vis Yellow) Includes: 4 Small Pockets, Multiple D-Rings, Reflective Patches, Hanging Loop
TWWGHAB	BUILD PRO	Adjustable Padded Shoulder Brace (Black) Includes: 4 Small Pockets, Multiple D-Rings, Reflective Patches, Hanging Loop
JKB-BELT	JACKMAN	Replacement Belt for Tool Pouch JKB-002
TWWGLBWB32	BUILD PRO	Leather Work Belt (32")
TWWGLBWB34	BUILD PRO	Leather Work Belt (34")
TWWGLBWB36	BUILD PRO	Leather Work Belt (36")
TWWGLBWB38	BUILD PRO	Leather Work Belt (38")
TWWGLBWB40	BUILD PRO	Leather Work Belt (40")
TWWGLBBUTB32	BUILD PRO	BACKPRO® Utility Tool Belt (32")
TWWGLBBUTB34	BUILD PRO	BACKPRO® Utility Tool Belt (34")
TWWGLBBUTB36	BUILD PRO	BACKPRO® Utility Tool Belt (36")
TWWGLBBUTB38	BUILD PRO	BACKPRO® Utility Tool Belt (38")
TWWGLBBUTB40	BUILD PRO	BACKPRO® Utility Tool Belt (40")

TOOL BAGS:
Dimensions (LxWxH)

DRTR14	DRAPER	PVC Tool Roll - 14 Pockets	675 x 330mm
JKB-081	JACKMAN	Carry Handy Tools Organiser Pockets: 14 Interior, 16 Exterior, 1 Large Side, 1 Hook	290 x 220 x 340mm
JKB-243	JACKMAN	Carry Handy Tools Organiser Pockets: 5 Interior, 15 Exterior, 24 Webbing Loops, 2 Velco Nylon, 1 Tape Clip, 1 Chain	510 x 220 x 280mm
JKB-210	JACKMAN	Toolbag Box Pockets: 1 Large Zip-up Compartment, 12 Interior, 14 Exterior	365 x 230 x 230mm
SRBGS	STARRETT	Hand Tool Bag Pockets: 1 Large Zip-up Compartment, 12 Exterior, 6 Interior	300 x 170 x 220mm
JKB-224	JACKMAN	Covered Tote Bag (Hard Rubber Base) Pockets: 1 Large Zip-up Compartment, 10 Interior, 8 Exterior	600 x 230 x 350mm
DRHVB600	DRAPER	Hi-Viz Tool Bag (Hard Rubber Base) Pockets: 1 Large Zip-up Compartment, 23 Exterior	600 x 280 x 260mm
JKB-240	JACKMAN	Bucket Tool Organiser Pockets: 30 Exterior, 13 Interior, 1 Hammer Holder, 1 Universal Hook	Ø 280mm

TOOL BOXES:
Dimensions (LxWxH)

ST93-935	STANLEY	FATMAX Structural Foam Tool Box Features: Removable Tote Tray, Integrated V-Groove on Lid for Sawing, Rust Proof Latches, Soft Grip Carry Handle, All Round Water Seal	710 x 320 x 294mm
DRTT500	DRAPER	Tote Tray Features: 2 Large & 2 Small Compartments, Pre-drilled Storage Holes, Sturdy Aluminium Soft Grip Handle	500 x 350 x 220mm
MMSB20201	MONUMENT	Tote Tray (For Soldering Copper Pipe Joints) Features: 2 Large & 1 Small Compartment, Gas Canister & Disconnected Blow Torch Compartment, Pipe Clamp for 15mm & 20mm Copper Pipes, Silicone Strip Edge	440 x 340 x 260mm
DRH5004	DRAPER	4-Tray Cantilever Tool Box	500 x 297 x 210mm
DRG6	DRAPER	Lockable Metal Tool Chest Features: 3 Small & 3 Large Drawers, Fitted with Anti Slip Mats, Top Compartment, Locking System	600 x 255 x 345mm



TWWGHAB
Adjustable Padded
Shoulder Brace



TWWGHAY
Adjustable Padded
Shoulder Brace

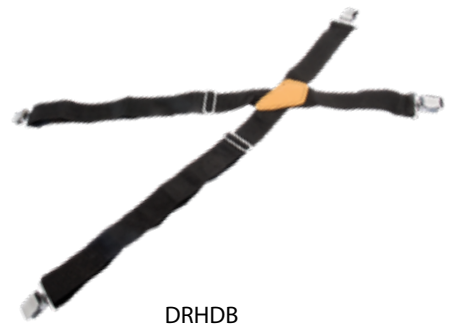

DRHDB
Adjustable Shoulder Brace



JKB-BELT
Replacement Belt for
Tool Pouch JKB-002



TWWGLBWB3 Series
Leather Work Belt
(Available Sizes: 32" - 40")



TWWGLBBUTB
BACKPRO® Utility Tool Belt
(Available Sizes: 32" - 40")



DRTR14
PVC Tool Roll



JKB-081
Carry Handy Tools Organiser



JKB-210
Polyester toolbag box



SRBG5
Hand Tool Bag



JKB-243
Carry Handy Tools Organiser



JKB-224
Covered Tote Bag
(Hard Rubber Base)



DRHVB600
Hi-Viz Tool Bag
(Hard Rubber Base)



JKB-240
Bucket Tool Organiser



DRTT500
Tote Tray



MMSB20201
Tote Tray



DRH5004
4-Tray Cantilever Tool Box



DRG6
Lockable Metal Tool Chest



ST93-935
Structural Foam Tool Box

BRICK TROWELS:

Length

Width

PHILADELPHIA PATTERN

MT19-FG11	MARSHALLTOWN	Philadelphia Pattern Brick Trowel with Durasoft Handle	280mm	140mm
MT19-FG12	MARSHALLTOWN	Philadelphia Pattern Brick Trowel with Durasoft Handle	305mm	152mm

WIDE LONDON PATTERN

MT34-FG12	MARSHALLTOWN	Wide Heel Brick Trowel with Durasoft Handle	305mm	146mm
MT34L-FG12	MARSHALLTOWN	London Pattern Brick Trowel with Leather Handle	305mm	146mm

LONDON PATTERN

MT33-FG11	MARSHALLTOWN	London Pattern Brick Trowel with Durasoft Handle	280mm	124mm
MT33-FG12	MARSHALLTOWN	London Pattern Brick Trowel with Durasoft Handle	305mm	130mm
MT33-FG13	MARSHALLTOWN	London Pattern Brick Trowel with Durasoft Handle	330mm	136mm
MT926	MARSHALLTOWN	London Pattern Brick Trowel with Wood Handle	254mm	120mm
MTBTSG11	MARSHALLTOWN	London Pattern Brick Trowel with Soft Grip Handle	280mm	120mm
RG280-275	RAGNI	London Pattern Brick Trowel with Soft Grip Handle	280mm	140mm

PLASTERERS HAWKS:

Size

MTAH659	MARSHALLTOWN	Aluminium Hawk with Wood Handle	325mm x 325mm
MT1D	MARSHALLTOWN	Aluminium Hawk with Durasoft Handle	330mm x 330mm
MT2D	MARSHALLTOWN	Aluminium Hawk with Durasoft Handle	343mm x 343mm



MT19-FG11
Philadelphia pattern brick trowel



MT34-FG12
Wide heel brick trowel



MT926
London pattern brick trowel



RG280-275
London pattern brick trowel



MTBTSG11
London pattern brick trowel



MT33-FG11
London pattern brick trowel



MT34L-FG12
Leather Brick Trowel



MTAH659
Wood handle Hawk

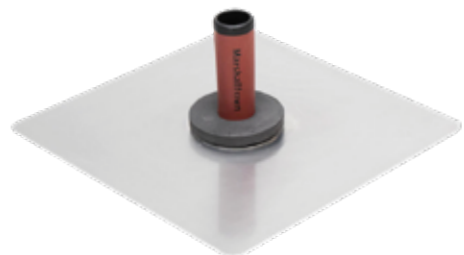

MT1D
Durasoft handle Hawk

CONCRETE FINISHING TROWELS:

Handle

length

width

MT11SSD	MARSHALLTOWN	Stainless steel finishing trowel	Durasoft	200mm	75mm
MTMXS1D	MARSHALLTOWN	Steel finishing trowel	Durasoft	275mm	113mm
MT1GSFPD	MARSHALLTOWN	Gold stainless PERMASHAPE finishing trowel	Durasoft	279mm	114mm
MTMXS1GSD	MARSHALLTOWN	Gold stainless steel finishing trowel	Durasoft	275mm	113mm

POOL TROWELS:

Handle

length

width

MTSP10SD	MARSHALLTOWN	Steel pool trowel	Durasoft	250mm	75mm
MTSP12SD	MARSHALLTOWN	Steel pool trowel	Durasoft	300mm	90mm
MTSP14SD	MARSHALLTOWN	Steel pool trowel	Durasoft	350mm	100mm
MTSP14GSD	MARSHALLTOWN	Gold Stainless steel pool trowel	Durasoft	350mm	100mm
MTSP16SD	MARSHALLTOWN	Steel pool trowel	Durasoft	400mm	113mm
MTSP16GSD	MARSHALLTOWN	Gold Stainless steel pool trowel	Durasoft	400mm	113mm
MTSP815SD	MARSHALLTOWN	Steel pool trowel	Durasoft	450mm	125mm
MTSP205SD	MARSHALLTOWN	Steel pool trowel	Durasoft	500mm	125mm

FINISHING TROWEL HANDLES:

MTX402D	MARSHALLTOWN	Finishing trowel handle - Durasoft
MTX402W	MARSHALLTOWN	Finishing trowel handle - wood



MTMXS1D
Steel finishing trowel



MT11SSD
Stainless steel finishing trowel



MT1GSFPD
Gold stainless permashape trowel



MTMXS1GSD
Golden stainless steel finishing trowel



MTSP10SD
Steel pool trowel



MTSP12SD
Steel pool trowel



MTSP14SD
Steel pool trowel



MTSP14GSD
Gold stainless pool trowel



MTSP16SD
Steel pool trowel



MTSP16GSD
Gold stainless steel pool trowel



MTSP815SD
Steel pool trowel



MTSP205SD
Steel pool trowel



MTX402W
Wood finishing trowel handle



MTX402D
Durasoft finishing trowel handle

CEMENTERS TROWELS:
size (mm)

MTMXS62GSD	MARSHALLTOWN	Golden stainless cementers trowel - Durasoft handle	300 x 100
MTMXS7GSD	MARSHALLTOWN	Gold stainless cementers trowel - Durasoft handle	300 x 125
MTMXS64D	MARSHALLTOWN	Carbon steel cementers trowel - Durasoft handle	350 x 100
MTMXS64GSD	MARSHALLTOWN	Gold stainless cementers trowel - Durasoft handle	350 x 100
MTMXS64FRD	MARSHALLTOWN	Round ends steel cementers trowel - Durasoft handle	350 x 100
MTMXS73GSD	MARSHALLTOWN	Gold stainless cementers trowel - Durasoft handle	350 x 119
MTMXS145GD	MARSHALLTOWN	Gold stainless cementers trowel - Durasoft handle	350 x 125
MTPB145GSD	MARSHALLTOWN	Gold stainless Permashape trowel - Durasoft handle	350 x 125
MTMXS66D	MARSHALLTOWN	Carbon steel cementers trowel - Durasoft handle	400 x 100
MTMXS66GSD	MARSHALLTOWN	Gold stainless cementers trowel - Durasoft handle	400 x 100
MTMXS66FRD	MARSHALLTOWN	Round ends steel cementers trowel - Durasoft handle	400 x 100
MTMXS66RED	MARSHALLTOWN	Round front end steel cementers trowel - Durasoft handle	400 x 100
MTMXS165GD	MARSHALLTOWN	Gold stainless cementers trowel - Durasoft handle	400 x 125
MTMXS81D	MARSHALLTOWN	Carbon steel cementers trowel - Durasoft handle	450 x 100
MTMXS81RED	MARSHALLTOWN	Round front end steel cementers trowel - Durasoft handle	450 x 100
MTMXS81FRD	MARSHALLTOWN	Round ends steel cementers trowel - Durasoft handle	450 x 100
MTMXS815D	MARSHALLTOWN	Carbon steel cementers trowel - Durasoft handle	450 x 125
MTMXS815GD	MARSHALLTOWN	Gold stainless cementers trowel - Durasoft handle	450 x 125
MTMXS20D	MARSHALLTOWN	Carbon steel cementers trowel - Durasoft handle	500 x 100
MTMXS20FRD	MARSHALLTOWN	Round ends steel cementers trowel - Durasoft handle	500 x 100
MTMXS20RED	MARSHALLTOWN	Round front end steel cementers trowel - Durasoft handle	500 x 100
MTMXS205D	MARSHALLTOWN	Carbon steel cementers trowel - Durasoft handle	500 x 125
MTMXS205GD	MARSHALLTOWN	Gold stainless cementers trowel - Durasoft handle	500 x 125
MTMXS205FD	MARSHALLTOWN	Round ends steel cementers trowel - Durasoft handle	500 x 125
MTMXS205RD	MARSHALLTOWN	Round front end steel cementers trowel - Durasoft handle	500 x 125
MTMXS24BRD	MARSHALLTOWN	Round ends blue steel finishing trowel - Durasoft handle	600 x 100
MTPF11D	MARSHALLTOWN	Permafex trowel - Durasoft Handle	275mm
MTPF12D	MARSHALLTOWN	Permafex trowel - Durasoft Handle	300mm
MTPFT145	MARSHALLTOWN	QLT Pointed Finishing Trowel	365 x 120
MTPFT18	MARSHALLTOWN	QLT Pointed Finishing Trowel	450 x 113

MARSHALLTOWN DISPLAY HANG TAGS:
size/s

MTXWL622	MARSHALLTOWN	Hanger - Finishing Trowel	11.5" (292mm)
MTXWL390	MARSHALLTOWN	Hanger - Finishing Trowel	12" (305mm)
MTXWL623	MARSHALLTOWN	Hanger - Finishing Trowel	13" (330mm)
MTXWL391	MARSHALLTOWN	Hanger - Finishing Trowel	14" (356mm)
MTXWL392	MARSHALLTOWN	Hanger - Finishing Trowel	16" (406mm)
MTXWL393	MARSHALLTOWN	Hanger - Finishing Trowel	18" (457mm)
MTXWL300	MARSHALLTOWN	Hanger - Small/Large Forgings	



MTMXS62GSD
Gold stainless steel
cementers trowel



MTMXS7GSD
Gold stainless steel
cementers trowel



MTMXS145GD
Gold stainless steel
cementers trowel



MTMXS64GSD
Gold stainless steel
cementers trowel



MTMXS64D
Steel cementers trowel



MTMXS64FRD
Steel round both ends
cementers trowel



MTMXS66GSD
Gold stainless steel
cementers trowel



MTMXS66RED
Steel round front end
cementers trowel



MTMXS66FRD
Steel round both ends
cementers trowel



MTMXS81D
Steel cementers trowel



MTMXS81RED
Steel round front end
cementers trowel



MTMXS815GD
Gold stainless steel
cementers trowel



MTMXS205FD
Steel round both ends
cementers trowel



MTMXS205D
Steel cementers trowel



MTMXS20D
Steel cementers trowel



MTPF11D
Permaflex trowel
stainless steel



MTPF12D
Permaflex trowel
stainless steel



MTPB145GSD
Permashape Gold stainless steel
cementers trowel



MTMXS24BRD
Fully rounded ends
finishing trowel - blue steel



MTPFT145
QLT Pointed
Finishing Trowel



MTXWL622
Finishing trowel hang tag



MTXWL300
Hang tag

96							
MAGNESIUM FLOATS:				end type	length	width	
MT143D	MARSHALLTOWN	Magnesium float - Durasoft handle	Round	400mm	80mm		
TW143	STANWAY	Magnesium float - TPR handle	Round	405mm	80mm		
MT142D	MARSHALLTOWN	Magnesium float - Durasoft handle	Square	300mm	80mm		
MT145D	MARSHALLTOWN	Magnesium float - Durasoft handle	Square	400mm	80mm		
TW145	STANWAY	Magnesium float - TPR handle	Square	405mm	80mm		
MT146D	MARSHALLTOWN	Magnesium float - Durasoft handle	Square	500mm	80mm		
TW146	STANWAY	Magnesium float - TPR handle	Square	508mm	80mm		
MT740D	MARSHALLTOWN	"The Hog" Magnesium float - Durasoft handle	Square	508mm	95mm		
WOODEN FLOATS:					length	width	
TW6411	STANWAY	Wood finishing float - plastic handle		280mm	110mm		
TW6415	STANWAY	Wood finishing float - plastic handle		380mm	110mm		
PLASTIC FLOATS:					length	width	
TW6280	STANWAY	Plastic float - one piece moulding		280mm	110mm		
TW6340	STANWAY	Plastic float - one piece moulding		340mm	150mm		
SUNDRY FINISHING FLOATS/TOOLS:				height	length	width	
MT38	MARSHALLTOWN	Rubber float - fine grit		225mm	100mm		
MT39	MARSHALLTOWN	Rubber float - coarse grit		225mm	100mm		
MT43	MARSHALLTOWN	Tile grouters float		225mm	100mm		
KB-FTST64	STANWAY	Stipple float		270mm	120mm		
RV4505	RAVEN	Bailer Sailor sponge	35mm	160mm	115mm		
RV4513	RAVEN	Bailer Sailor sponge	90mm	175mm	140mm		
FINISHING FLOAT HANDLES:							
MTX16D	MARSHALLTOWN	Magnesium float handle - Durasoft					
MTX16M	MARSHALLTOWN	Magnesium float handle - wood					
MTX16SCR	MARSHALLTOWN	Magnesium float handle screw					



MT145D
Magnesium float



TW145
Magnesium float



MT146D
Magnesium float



TW146
Magnesium float



MT143D
Magnesium float



TW143
Magnesium float



TW6411
Wood float



TW6280
Plastic float



MT38
Rubber float



MT43
Tile float



KB-FTST64
Stipple float



RV4505
Bailor sailor sponge



RV4513
Jumbo sponge



MTX16M
Mag float handle - Wood



MTX16D
Mag float handle - Durasoft

FRESNO TROWELS:
size

MT24R	MARSHALLTOWN	Carbon steel Fresno trowel - Round ends <i>Fitted with clevis bracket</i>	600 x 125mm
KB-SSW2	STANWAY	Stainless steel walking trowel - Round ends	600 x 120mm
KB-FSS2	STANWAY	Stainless steel fresno trowel - Round ends	900 x 120mm
MT3742	MARSHALLTOWN	Groover attachment - for all Fresno trowels	6 x 20 x 25mm
MT10H	MARSHALLTOWN	Wood handle for clevis bracket tools Suits models: MT24R, MT4012, MT4119, MT836	1800mm
MTFT6	MARSHALLTOWN	Push button handle adaptor <i>to fit clevis bracket tools</i>	225mm
MTBFH9	MARSHALLTOWN	Threaded handle adaptor <i>to fit clevis bracket tools</i>	225mm
MTX3748	MARSHALLTOWN	Fresno adaptor - for fitting to threaded handles	

BULLFLOATS, HANDLES AND ATTACHMENTS:

KB-SBF0915	STANWAY	Aluminium Bullfloat hea	915 x 150mm
KB-SBF1220	STANWAY	Aluminium Bullfloat head - handle rotation blade lift	1200 x 150mm
KB-EXT	STANWAY	Aluminium alloy telscopic handle - extends to 5130mm Suits models: KB-SBF1220, KB-SSW2, KB-FSS2	2700mm
MTB45	MARSHALLTOWN	Magnesium Bullfloat head - Square ends	1140 x 200mm
MTB48FR	MARSHALLTOWN	Magnesium Bullfloat head - Round ends	1200 x 200mm
MTMB48RB	M/TOWN QLT	Magnesium Bullfloat head - Round ends - Blade only	1200 x 200mm
MT4712	MARSHALLTOWN	Groover attachment - for all magnesium Bullfloats	6 x 19 x 25mm
MTB5-72	MARSHALLTOWN	Threaded Aluminium Bullfloat handle Suits models: MTB45, MTB45FR, MTCG101234W	1800mm
MT17-8ASU	MARSHALLTOWN	Aluminium snap system handle - BLUE Suits models: MTB45RA, MTBF9, MTX-RL6	44.0 x 1800mm
MTBF9	MARSHALLTOWN	Rock-it 2.0 adjustable Bullfloat bracket <i>to fit clevis bracket tools</i>	
MTBF8	MARSHALLTOWN	Push Button Handle Adaptor - male threaded - suits 35mm poles	

LONG HANDLED CEMENTERS TROWELS:
Size (mm):

MT826	MARSHALLTOWN	Spred-krete cement spreader - with single hook	500 x 100mm
MT828	MARSHALLTOWN	Wood handle for Spred-krete	1370mm
MTRED700156	MARSHALLTOWN	Aluminium Pull crete with handle and hook	500 x 1500mm
TW156	STANWAY	Aluminium Concrete Placer with Hook	508 x 1530mm
MTRED700158	MARSHALLTOWN	Aluminium Pull crete with handle (No hook)	500 x 1500mm
MTRED700109	MARSHALLTOWN	Magnesium Braced Lute - plain blade with 2.1m handle	76 x 813mm
MT4012	MARSHALLTOWN	Zinc walking edger - clevis bracket	225 x 100mm
MT4119	MARSHALLTOWN	S/Steel walking edger - clevis bracket	250 x 250mm
MT836	MARSHALLTOWN	Zinc walking groover - 13mm x 25mm - clevis bracket	200 x 113mm
MTCG101234W	MARSHALLTOWN	Chicago style Stainless steel walking groover	254 x 254mm

BULLFLOAT BRACKETS AND PARTS:

MTX-3003	MARSHALLTOWN	Bull float bracket assembly	
MTX-3001	MARSHALLTOWN	Bullfloat bracket socket	
MTX-3002	MARSHALLTOWN	Bullfloat bracket case	
MTX-3008	MARSHALLTOWN	Bullfloat universal mounting plate	
MTX-3010	MARSHALLTOWN	Bullfloat handle male thread	
MTX-3011	MARSHALLTOWN	Bullfloat handle female thread	



MTB45
Bullfloat Head - standard bracket



MT4012
walking edger

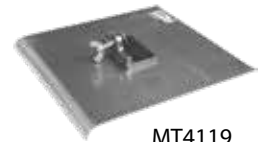

MT4119
walking edger



MTMB48RB
Magnesium bullfloat blade



KB-SBF1220
Aluminium Bullfloat



MT826
Spred-krete head



KB-FSS2
Stainless Fresno trowel



MT828
Spred krete handle



KB-EXT
teleopic handle



MTB5-72
Bullfloat handle



KB-SSW2
Stainless walking trowel



MT10H
Fresno handle



MT17-8ASU
push button handle



MT24R
Fresno trowel



MT836
walking groover

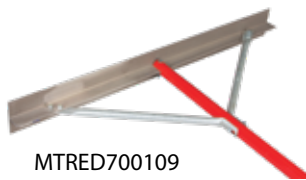

MTRED700109
asphalt lute



MTRED700158
Alum. Pull crete



MTRED700156
Alum. Pull crete
with hook



TW156
Alum. Pull crete
with hook



MT3742
Fresno groover attachment



MT4712
Bullfloat groover attachment



MTBFH9
threaded handle adaptor



MTCG101234W
Chicago walking groover



MTX3748
Fresno adaptor



MTX-3010



MTX-3011



MTFT6
push button handle adaptor



MTBF9
Rock-it bullfloat bracket



MTX-3003
standard bullfloat bracket



MTBF8
push button handle adaptor

CEMENT EDGING and GROOVING TOOLS:				radius	size
MT136	MARSHALLTOWN	Carbon steel Edger - Dura handle curved blade ends		10mm	150x75mm
MT130SSD	MARSHALLTOWN	Big 'I' stainless steel edger - Durasoft handle		10mm	250x150mm
MT4280D	MARSHALLTOWN	Stainless Steel Safety Step Hand Edger/Groover		13mm	152x127mm
MT155SSD	MARSHALLTOWN	Stainless edger - Durasoft handle curved blade ends		6mm	150x100mm
MT156SSD	MARSHALLTOWN	Stainless edger - Durasoft handle curved blade ends		10mm	150x100mm
MT162SS	MARSHALLTOWN	Stainless edger - Durasoft handle straight blade ends		10mm	150x150mm
MT480CH	MARSHALLTOWN	Stainless Steel Chamfer Hand Edger		13mm	150 x 200mm
MT3629	MARSHALLTOWN	Combo Adjust Stainless Steel Walking Edger		10mm	203x102mm
MT4154	MARSHALLTOWN	Zinc Edger - wood handle with curved blade ends		6mm	150x70mm
MT92	NU PRIDE	Carbon steel Edger - wood handle curved blade ends		10mm	150x70mm
MT180	MARSHALLTOWN	Stainless steel groover - 13mm x 13mm groove		6mm	150x75mm
MT834D	MARSHALLTOWN	Zinc groover - Durasoft handle 10mm x 19mm groove		6mm	150x110mm
MT835D	MARSHALLTOWN	Zinc groover - Durasoft handle 10mm x 25mm groove		6mm	150x110mm
MT91	NU PRIDE	Carbon steel groover - 13mm groove			150x70mm
WINDOW TROWELS:					size
RG314-10	STANWAY	Trowel and square			10mm
RG314-13	STANWAY	Trowel and square			13mm
RG314-16	RAGNI	Trowel and square			16mm
RG314-19	STANWAY	Trowel and square			19mm
RG314-25	RAGNI	Trowel and square			25mm
MT503-06	MARSHALLTOWN	Window trowel (Tuck pointer) - wood handle			6mm
MT504-08	MARSHALLTOWN	Window trowel (Tuck pointer) - wood handle			8mm
MT505-10	MARSHALLTOWN	Window trowel (Tuck pointer) - wood handle			10mm
MT506-13	MARSHALLTOWN	Window trowel (Tuck pointer) - wood handle			13mm
MT97	NU PRIDE	Margin trowel - wood handle			125mm x 50mm
JOINTERS:					
MT83	MARSHALLTOWN	Brick jointer			10mm x 13mm
MT80	MARSHALLTOWN	Brick jointer			13mm x 16mm
MT82	MARSHALLTOWN	Brick jointer			16mm x 19mm
MT923	NU PRIDE	Brick jointer			10mm x 13mm
MT89	MARSHALLTOWN	Skate wheel joint raker			
MT32	MARSHALLTOWN	Standard slicker - flat profile			6mm x 10mm
MT611D	MARSHALLTOWN	Half round sled runner -Durasoft handle			375mm x 13mm
MT613D	MARSHALLTOWN	Half round sled runner - Durasoft handle			450mm x 13mm
MT614D	MARSHALLTOWN	Half round sled runner - Durasoft handle			450mm x 16mm



MT32
Standard slicker 6mm x 10mm



MT83
Brick jointer



MT89
Skate wheel joint raker



RG314-19
Stanway Trowel and square



RG314-16
Ragni Trowel and square



MT506-13
Window trowel



MT97
Margin trowel



MT4280D
Hand Edger/Groover



MT3629
Walking Edger



MT91
Steel Groover



MT136
Steel Edger



MT92
Steel Edger



MT180
Stainless steel Groover



MT130SSD
Stainless steel edger



MT156SSD
Stainless steel Edger



MT834D
Zinc Groover



MT613
Half round sled runner



MT4154
Zinc Edger

SUNDRY CEMENT FINISHING TROWELS:
size (mm)

MT5786	MARSHALLTOWN	EIFS Inside corner tool - S/S Durasoft handle - 90°	106 x 25
MT5787	MARSHALLTOWN	EIFS Inside corner tool - S/S Durasoft handle - 90°	106 x 38
MT5788	MARSHALLTOWN	EIFS Inside corner tool - S/S Durasoft handle - 90°	106 x 50
MT2160	QLT	EIFS Texturing trowel - durable plastic blade resilient handle	275 x 140
MT65SSD	MARSHALLTOWN	S/S Inside Corner Trowel - Square Finish	150 x 64
MT67SSD	MARSHALLTOWN	S/S Outside Corner Trowel - Square Finish	150 x 64
MT68SSD	MARSHALLTOWN	S/S Outside corner trowel -Durasoft handle - 13mm radius	150 x 63
MT4268	MARSHALLTOWN	S/S Outside curb tool - Durasoft handle - 19mm radius	150 x 113
MT722	MARSHALLTOWN	Scarifier - 6mm x 75mm blue steel tines	200mm

POINTING TROWELS:
size (mm)

MT95	NU PRIDE	Pointing trowel - wood handle	140mm
MT925	NU PRIDE	Pointing trowel - wood handle	175mm
RG160-150	RAGNI	Pointing trowel - wood handle	150mm
MTPTSG6275	MARSHALLTOWN	Pointing trowel - soft grip handle	150mm

GAUGING TROWELS:
size (mm)

MT47A	MARSHALLTOWN	Bull nose insulation trowel - wood handle	140mm
MT48A	MARSHALLTOWN	Bull nose insulation trowel - wood handle	175mm
MT48	MARSHALLTOWN	Gauging trowel - wood handle	175mm
MT48D	MARSHALLTOWN	Gauging trowel - Durasoft handle	175mm
MT924	NU PRIDE	Gauging trowel - wood handle	175mm
RG129-175	RAGNI	Gauging trowel - soft grip handle	175mm
MTGTSG735	MARSHALLTOWN	Gauging trowel - soft grip handle	175mm



MT5788
EIFS Inside corner tool



MT2160
EIFS texturing trowel



MT5787
EIFS Inside corner tool



MT65SSD
Inside corner tool



MT67SSD
Outside corner tool



MT68SSD
Outside corner tool



MT722
Scarifier



MT4268
Stainless steel outside curb tool



MT95
Pointing trowel



MT925
Pointing trowel



MTPTSG6275
Pointing trowel



RG160-150
Pointing trowel



MT47A
Bull nose insulation trowel



MT924
Gauging trowel



MTGTSG735
Gauging trowel



MT48D
Gauging trowel



RG129-175
Gauging trowel

100				
DRYWALL TROWELS:				size
MT12SSD	MARSHALLTOWN	Stainless curved drywall finishing trowel - Durasoft handle		275mm x 113mm
MT12ASSD	MARSHALLTOWN	Stainless curved drywall finishing trowel - Durasoft handle		350mm x 113mm
RG230R	RAGNI	Superlite plasterers finishing trowel		280mm x 120mm
RG318-11	RAGNI	Carbon steel plasterers trowel		275mm x 120mm
RG619S-275	RAGNI	Flexlite skimming trowel with Hilift handle		280mm x 120mm
RG619S-350	RAGNI	Flexlite skimming trowel with Hilift handle		355mm x 120mm
MTCT911	QLT	S/Steel Inside corner trowel - rubber handle		102mm x 127mm
MT23RD	MARSHALLTOWN	Stainless steel Inside corner trowel Durasoft handle		125mm x 100mm
MT25RD	MARSHALLTOWN	Stainless steel Outside corner trowel Durasoft handle		125mm x 95mm
RG65401S	RAGNI	Stainless Steel Internal Corner Trowel		120mm x 100mm
MT292	NU PRIDE	DIY plastic inside corner trowel		188mm x 113mm
DRYWALL SANDERS:				
MT200P	MARSHALLTOWN	Hand sander - Durasoft® handle		225mm x 80mm
MT260P	MARSHALLTOWN	Pole sander head - moulded plastic		229mm x 82mm
HDKIC1200	UNI PRO	DIY pole sander handle - wood		1200mm
MTRPS9H	MARSHALLTOWN	Radial pole sander		229mm
MTSKIM030	MARSHALLTOWN	ProSkim Skimming spatula		300mm
MTSKIM045	MARSHALLTOWN	ProSkim Skimming spatula		450mm
MTSKIM060	MARSHALLTOWN	ProSkim Skimming spatula		600mm
MTSKIM080	MARSHALLTOWN	ProSkim Skimming spatula		800mm
MTSKIM100	MARSHALLTOWN	ProSkim Skimming spatula		1000mm
MTSKIM120	MARSHALLTOWN	ProSkim Skimming spatula		1200mm
MTSKIMBRKT	MARSHALLTOWN	ProSkim spatula handle bracket		1.0 - 1.9m
MTSKIM1-2M	MARSHALLTOWN	ProSkim spatula handle		1200mm
MT48ALUMB	MARSHALLTOWN	Aluminium pole sander handle		
MT390	MARSHALLTOWN	Drywall rasp - Durasoft handle		
DRYWALL SANDING DISCS:				grit pack size
MTPREM080	MARSHALLTOWN	Premiere sanding discs	80 grit	5 pk
MTPREM100	MARSHALLTOWN	Premiere sanding discs	100 grit	5 pk
MTPREM120	MARSHALLTOWN	Premiere sanding discs	120 grit	5 pk
MTPREM150	MARSHALLTOWN	Premiere sanding discs	150 grit	5 pk
MTPREM180	MARSHALLTOWN	Premiere sanding discs	180 grit	5 pk
MTPREM220	MARSHALLTOWN	Premiere sanding discs	220 grit	5 pk
MTDISC080	MARSHALLTOWN	Standard sanding discs	80 grit	5 pk
MTDISC100	MARSHALLTOWN	Standard sanding discs	100 grit	5 pk
MTDISC120	MARSHALLTOWN	Standard sanding discs	120 grit	5 pk
MTDISC150	MARSHALLTOWN	Standard sanding discs	150 grit	5 pk
MTDISC180	MARSHALLTOWN	Standard sanding discs	180 grit	5 pk
MTDISC220	MARSHALLTOWN	Standard sanding discs	220 grit	5 pk
STRAIGHT EDGES:				
SWSVE121	SAVAGE	Non-slip aluminium straight edge with markings		1200mm
SWSVE183	SAVAGE	Non-slip aluminium straight edge with markings		1800mm
SWSVE244	SAVAGE	Non-slip aluminium straight edge with markings		2400mm
KB-SE1800	STANWAY	Powder coated aluminium straight edge w end caps	1800mm x 70mm x 20mm	
KB-SE2400	STANWAY	Powder coated aluminium straight edge w end caps	2400mm x 70mm x 20mm	
KB-SE3000	STANWAY	Powder coated aluminium straight edge w end caps	3000mm x 70mm x 20mm	
DRYWALL SQUARES:				
MT27XM	MARSHALLTOWN	Drywall T-Square		1200mm
TW1220HD	STANWAY	Heavy duty drywall square - 5mm thick		1220mm
SWSVW1350M	SAVAGE	Heavy duty drywall square - 4.7mm thick		1350mm
DRYWALL LIFTERS:				
MT790	MARSHALLTOWN	Drywall board lifter		
MT589	QLT	Drywall board lifter with bottle opener		
DRYWALL TAPERS AND WIPERS:				
MT798D	MARSHALLTOWN	Tapesooter® drywall Taper - Right hand model		275mm x 75mm
MT31	MARSHALLTOWN	Drywall Tape Reel		260mm x 76mm
DRYWALL MUD PAN:				
MT6396	MARSHALLTOWN	Heli-Arc Stainless drywall mud pan		350mm x 70mm



MT12SSD
Stainless Curved
drywall trowel



MT12ASSD
Stainless Curved
drywall trowel



RG230R
Superlite plastering
trowel



RG318-11
Carbon steel
plastering trowel



RG619S-275
Flexlite Skimming
Trowel



MTCT911
Stainless steel
inside corner tool



MT25RD
Stainless steel
Outside corner tool



MT292
DIY inside corner tool



MT23RD
Stainless radius
inside corner tool



RG65401S
Stainless steel
inside corner tool



MT390
Drywall rasp



MT589
Drywall board lifter



MT798D
Tapesooter drywall taper



MT31
Drywall Tape Reel



MT6396
Drywal mud pan
Stainless steel



MT790
Drywall board lifter



MT260P
Pole sander head



MT200P
Hand sander



MTSKIMBRKT
Proskim handle bracket



MTRPS9H
Radial pole sander



MTSKIM060
Proskim skimming spatula



MTSKIM100
Proskim skimming spatula



MTSKIM1-2M
Proskim spatula handle



MTPREM100
Premium sanding disc



MTDISC100
Standard sanding disc

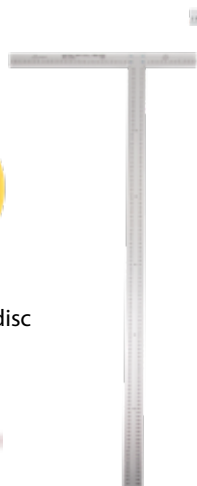

MT27XM
Drywall
T-Square

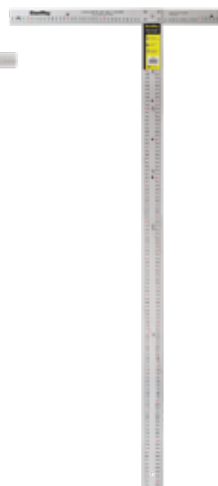

TW1220HD
Drywall
T-Square



SWSVE183
Straight edge

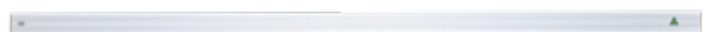

KB-SE2400
Straight edge



HDKIC1200
DIY Pole sander handle



MT48ALUMB
Aluminium pole sander
handle

101		PLAIN SPREADERS:		blade width
MTPK764SSD	MARSHALLTOWN	Flex putty knife - Durasoft handle - Stainless steel	50mm	
MTSK880SSD	MARSHALLTOWN	Flex putty knife - Durasoft handle - Stainless steel	75mm	
MTSK882SSD	MARSHALLTOWN	Flex putty knife - Durasoft handle - Stainless steel	100mm	
MTJK884SSD	MARSHALLTOWN	Flex putty knife - Durasoft handle - Stainless steel	125mm	
MTJK886SSD	MARSHALLTOWN	Flex putty knife - Durasoft handle - Stainless steel	150mm	
MTPK876D	MARSHALLTOWN	Flex putty knife - Durasoft handle	38mm	
MTPK878D	MARSHALLTOWN	Flex putty knife - Durasoft handle	50mm	
MTSK879D	MARSHALLTOWN	Flexible scraper - Durasoft handle	75mm	
MT6267	MARSHALLTOWN	Plastic putty knife	38mm	
MT6268	MARSHALLTOWN	Plastic putty knife	50mm	
MT6269	MARSHALLTOWN	Plastic putty knife	75mm	
MT6270	MARSHALLTOWN	Plastic putty knife	100mm	
MTSK882D	MARSHALLTOWN	Flexible scraper - Durasoft handle	100mm	
MTJK884D	MARSHALLTOWN	Hammer head flexible joint knife - Durasoft handle	125mm	
MTJK886D	MARSHALLTOWN	Hammer head flexible joint knife - Durasoft handle	150mm	
MTSSPK2	MARSHALLTOWN	Stainless Steel Putty Knife	50mm	
MTSSJK4	MARSHALLTOWN	Stainless Steel Joint Knife	100mm	
MTSSJK6	MARSHALLTOWN	Stainless Steel Joint Knife	150mm	
RQJK05S	RAGNI	Stainless steel jointing knife	125mm	
RQJK06S	RAGNI	Stainless steel jointing knife	150mm	
MTBK387	QLT	Long broad knife - 809mm aluminium handle	175mm	
MT3508SD	MARSHALLTOWN	Stainless steel taping knife - Durasoft handle	200mm	
MT3510SD	MARSHALLTOWN	Stainless steel taping knife - Durasoft handle	250mm	
MT3512SD	MARSHALLTOWN	Stainless steel taping knife - Durasoft handle	305mm	
MT3514SD	MARSHALLTOWN	Stainless steel taping knife - Durasoft handle	350mm	
RGTK08S	RAGNI	Stainless steel taping knife	200mm	
RGTK10S	RAGNI	Stainless steel taping knife	250mm	
RGTK12S	RAGNI	Stainless steel taping knife	300mm	
MT6271	MARSHALLTOWN	Plastic taping knife	150mm	
MT6272	MARSHALLTOWN	Plastic taping knife	200mm	
MT6273	MARSHALLTOWN	Plastic taping knife	250mm	
NOTCHED TROWELS:				
MT6261	NU PRIDE	Disposable 3mm 'V' Notched trowel	250mm x 106mm	
MT6262	NU PRIDE	Disposable 5mm 'V' Notched trowel	250mm x 106mm	
MT6263	NU PRIDE	Disposable 10mm 'V' Notched trowel	250mm x 106mm	
NOTCHED SPREADERS:				
MT6286	NU PRIDE	Plastic notched spreader - 3mm, 5mm, 6mm 'V' notch	100mm x 100mm	
MT6287	NU PRIDE	Plastic notched spreader - 2mm, 3mm, 6mm Square notch	100mm x 100mm	
MT980	NU PRIDE	Galvanised steel notched spreader - 6mm 'V' notch	150mm x 100mm	
CONCRETE SCREEDS:				length
KB-S1200	STANWAY	Aluminium concrete screed - Reversible and replaceable handles	1.2m	
KB-S1500	STANWAY	Aluminium concrete screed - Reversible and replaceable handles	1.5m	
KB-S1800	STANWAY	Aluminium concrete screed - Reversible and replaceable handles	1.8m	
KB-S2400	STANWAY	Aluminium concrete screed - Reversible and replaceable handles	2.4m	
KB-S3000	STANWAY	Aluminium concrete screed - Reversible and replaceable handles	3.0m	
KB-S3600	STANWAY	Aluminium concrete screed - Reversible and replaceable handles	3.6m	



MTPK876D
Flexible putty knife



MTSK879D
Flexible scraper



MTSK882D
Flexible putty knife



MTJK886D
Hammer head joint knife



RGJK055
Joint knife



RGJK065
Joint knife



MT6268
Putty knife



MT6269
Putty knife



MT6271
Taping knife



MT6272
Taping knife



MT3514SD
Stainless steel taping knife



MTBK387
Long broad knife



RGTK085
Taping knife



RGTK105
Taping knife



RGTK125
Taping knife



MTSSPK2
Putty Knife



MTSSJK4
Joint Knife



MTSSJK6
Joint Knife



MT6286
Notched spreader



MT6287
Notched spreader



MT6261
Disposable notched trowel



MT6262
Disposable notched trowel



MT6263
Disposable notched trowel



KB-S1200
Aluminium concrete screed



MT980
Steel notched spreader
6mm

CEMENTERS RUBBER BUCKETS:
size

MTDF10	MILLER	Heavy duty rubber bucket - standard	10 quarts
MTDF12	MILLER	Heavy duty rubber bucket - standard	12 quarts
MTDFP18	MILLER	Heavy duty rubber bucket - pouring lip	18 quarts
RG6165S	RAGNI	Stainless Steel Bucket Trowel	165mm

CEMENTERS BLOCK TOOLS:

MT86P	MARSHALLTOWN	Line block set of 4 - plastic with 2 sets of twigs
FAILB	FAITHFULL	Plastic line block set with 18m string line
FP624-36	FOOTPRINT	Line/Corner Blocks - 36 pack
MT88	MARSHALLTOWN	Brick tongs
MT-LS68	MARSHALLTOWN	Line stretcher set
MT-ALS504	QLT	Adjustable line stretcher set
FP620C	FOOTPRINT	Line pin set of 2

TEXTURING and HOPPER GUNS:

FAIFLICKHD	FAITHFULL	External texturing/patching gun	
FAIX15-02	FAITHFULL	Replacement roller	
MT693	MARSHALLTOWN	Sharpshooter® Hopper gun	7.57 litres

ASPHALT MELTER/ APPLICATOR

MTAT10MA	MARSHALLTOWN	Melter and pourer all in one machine Comes complete with hand agitator, temp gauge, torch head, hose, regulator, propane bottle holder, spark ignitor, and hinge fill lid 10 gallon/ 42 litre capacity
MTRED704973	MARSHALLTOWN	Melter Torch Kit Assembly
MTRED704978	MARSHALLTOWN	Pressure Gauge
MTRED704979	MARSHALLTOWN	Temperature Gauge
MTRED704983	MARSHALLTOWN	1.8m Replacement Hose

PAINT and MUD MIXERS:

MT771	QLT	Ribbon design power mixer	400mm
MT772	QLT	Ribbon design power mixer	600mm
MT773	QLT	Ribbon design power mixer	762mm
MT819	MARSHALLTOWN	Quik-mix® power mixer	710mm
MTGB690	MARSHALLTOWN	Blu-tip Grout bag - seamless white plastic	nm x 600mm
MTDGB661	MARSHALLTOWN	Disposable grout bag	

CONCRETE BROOMS/BRUSHES:

MT829	MARSHALLTOWN	Masonry brush	165mm
MT830	MARSHALLTOWN	Concrete broom head	600mm
MT847	MARSHALLTOWN	Concrete broom head	900mm
HDKIC1200	HAYDN	Threaded handle for MT830 & MT847	1200mm
MTE54D	MARSHALLTOWN	Solid rubber seam roller	50mm



FP620C
Line pin set



MT86P
Line block set



MT88
Brick tongs



MT-ALS504
Adjustable line stretcher set



FAILB
Line block set



MTDGB661
Disposable Grout bag



MT-LS68
Line stretcher set



FP624-36
Line/Corner Blocks



MTGB690
Grout bag



MT819
Quik-mix
power mixer



MT771
Ribbon design
power mixer



MT829
Masonry brush



HDKIC1200
Broom handle



FAIFLICKHD
H/D Flicker spray system



FAIX15-02
Flicker replacement roller

MT847
Concrete broom head



MT693
Sharpshooter hopper gun



MTAT10MA
Asphalt melter/applicator



MTE54D
Seam Roller



MTDF12
Rubber bucket



RG6165S
Bucket Trowel



MTDFP18
Rubber bucket

103

LOCKING PLIERS - with GRIPCLIP:
capacity
length

GO111-07	GRIP-ON	Curved jaw - finger lift release	0 - 42mm	190mm
GO111-10	GRIP-ON	Curved jaw - finger lift release	0 - 63mm	235mm
GO112-07	GRIP-ON	Straight jaw - finger lift release	0 - 42mm	190mm
GO112-10	GRIP-ON	Straight jaw - finger lift release	0 - 63mm	235mm
GO121-05	GRIP-ON	Curved jaw with wire cutter - finger lift release	0 - 30mm	135mm
GO121-10	GRIP-ON	Curved jaw with wire cutter - finger lift release	0 - 63mm	235mm

SPECIALTY LOCKING TOOLS:
capacity
length

GO128-08	GRIP-ON	Sheet metal tool - Gripclip and finger lift release	0 - 45mm	200mm
DRSMT200	DRAPER	Sheet metal tool - Gripclip and finger lift release	0 - 45mm	200mm
GO127-06	GRIP-ON	Long nose plier - Gripclip and finger lift release	0 - 55mm	165mm
GO127-10	GRIP-ON	Long nose plier - Gripclip and finger lift release	0 - 70mm	235mm
GO181-10	GRIP-ON	Locking chain clamp - finger lift release	160mm	250mm
GO182-10	GRIP-ON	Chain pipe cutter - finger release	15 - 75mm	250mm
GO124-06	GRIP-ON	Locking 'C' Clamp - finger lift release	0 - 60mm	165mm
GO222-12	GRIP-ON	Table mount C-Clamp		300mm
GOX-TNUT	GRIP-ON	T-Nut and bolt for GO222-12		
GO224-12	GRIP-ON	Locking 'C' Clamp w swivel pads - finger lift release	0 - 80mm	320mm
GO224-18	GRIP-ON	Locking 'C' Clamp w swivel pads - finger lift release	0-240mm	470mm
GO233-06	GRIP-ON	Self levelling jaw clamp	0 - 60mm	190mm



GO127-06
Long nose



GO121-10
Curved jaw with wire cutter



GO111-10
Curved jaw



GO112-10
Straight jaw



GO128-08
Sheet metal tool



DRSMT200
Sheet metal tool



GO233-06
Self levelling jaw clamp



GO224-12
Locking 'C' clamp with pads



GO124-06
Locking 'C' clamp



GO181-10
Locking chain clamp



GO182-10
Chain pipe cutter

METALWORK VICES:

jaw width jaw opening

DRMVF100	DRAPER	Engineers bench vice - Fixed base	100mm
DRMVF125	DRAPER	Engineers bench vice - Fixed base	125mm
DRMVF150	DRAPER	Engineers bench vice - Fixed base	150mm
DRMVF200	DRAPER	Engineers bench vice - Fixed base	200mm

VICE SPARE PARTS AND ACCESSORIES:

size

BSRJAW150	BLACK STEEL	Replacement jaws for mechanic and workshop vices	150mm
BSRJAW200	BLACK STEEL	Replacement jaws for mechanic and workshop vices	200mm

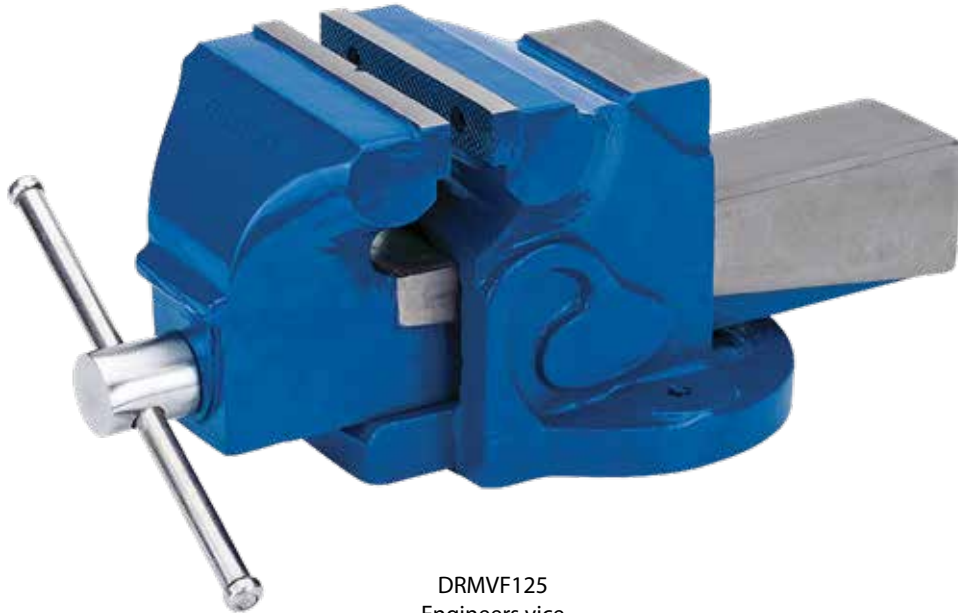

DRMVF125
Engineers vice

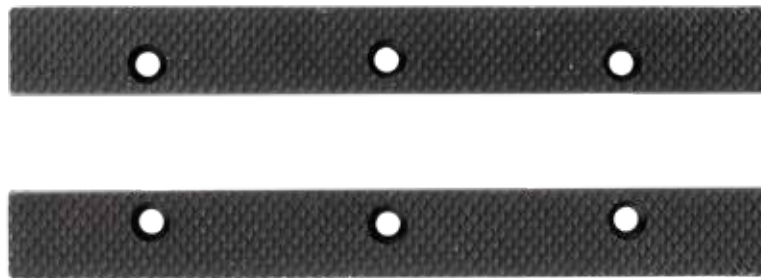

BSRJAW200
Vice jaws

105		SCRATCH WIRE BRUSHES:			size (mm)
SC017-010	SIT	Mixed boxes of SPID steel wire brushes - INOX, BRASS, NYLON, STEEL			48pc
PG010	PG	Brass plated steel wire hand brush - Red handle			240
SC011	SIT	Stainless Steel Brush - Green Handle			270
DR1808	DRAPER	File cleaning wire brush			210 x 25
DR1802	DRAPER	4 row steel wire hand brush - curved wood handle			290 x 36
WIRE CUP BRUSHES:				size (mm)	bore
SC128	SIT	Brass plated crimped 0.30mm steel wire cup brush		75 x 25	M14
DR0241	DRAPER	Twist knot 0.35 steel wire cup brush		71 x 17	M15
WIRE CONICAL BRUSHES:				size (mm)	bore
SC315	SIT	Twist knot 0.50mm steel wire conical brush		120 x 22	M14
SHAFT MOUNTED BRUSHES:				size (mm)	shaft (mm)
DR0855	DRAPER	Shaft mounted steel wire circular brush		50	6
DR0820	DRAPER	Shaft mounted steel wire end brush			6 x 26
SC880	SIT	Shaft mounted clepsydra steel wire brush		60/40	10 x 28



PG010
Brass wire hand brush



SC011
Stainless Steel Brush



SC017-010
Mixed wire hand brush
display pack - 48pc



DR1802
Wood handle wire hand brush



DR1808
Wood handle file cleaning brush



DR0820
Steel shaft wire
end brush



DR0855
Steel shaft wire
circular brush



DR0241
Steel twist
cup brush



SC880
Shaft mounted clepsydra
sreel wire brush

106					
ADJUSTABLE WRENCHES:				max opening	length
IG77-04	IREGA	Drop forged alloy steel adjustable wrench		13mm	100mm
IG77-06	IREGA	Drop forged alloy steel adjustable wrench		19mm	150mm
IG77-08	IREGA	Drop forged alloy steel adjustable wrench		24mm	200mm
IG77-10	IREGA	Drop forged alloy steel adjustable wrench		29mm	250mm
IG77-12	IREGA	Drop forged alloy steel adjustable wrench		34mm	300mm
IG77-15	IREGA	Drop forged alloy steel adjustable wrench		43mm	375mm
IG77-18	IREGA	Drop forged alloy steel adjustable wrench		53mm	450mm
IG77-24	IREGA	Drop forged alloy steel adjustable wrench		62mm	600mm
IG771-30	IREGA	Drop forged alloy steel adjustable wrench		77mm	750mm
IG92WR-06	IREGA	Reversible jaw wrench		27mm	150mm
IG92WR-08	IREGA	Reversible jaw wrench		34mm	200mm
IG92WR-10	IREGA	Reversible jaw wrench		40mm	250mm
IG92WR-12	IREGA	Reversible jaw wrench		45mm	300mm
DR371CP-06	DRAPER	Chrome plated adjustable wrench		22mm	150mm
DR371CP-08	DRAPER	Chrome plated adjustable wrench		27mm	200mm
DR371CP-10	DRAPER	Chrome plated adjustable wrench		31mm	250mm
DR371CP-12	DRAPER	Chrome plated adjustable wrench		39mm	300mm
PALM WRENCHES					
PT8545	PLUMTOOL	Palm Wrench			
ADJUSTABLE WRENCHES - SUPER WIDE OPENING:				max opening	length
IG77SWO-08	IREGA	Super wide opening adjustable wrench		39mm	200mm
IG92SWO-06	IREGA	Ergo grip Super wide opening adjustable wrench		34mm	150mm
IG92SWO-08	IREGA	Ergo grip Super wide opening adjustable wrench		39mm	200mm
IG92SWO-10	IREGA	Ergo grip Super wide opening adjustable wrench		53mm	250mm
IG92XS-04	IREGA	Xtra slim ergo super wide opening adjustable wrench		13mm	100mm
IG92XS-06	IREGA	Xtra slim ergo super wide opening adjustable wrench		34mm	150mm
IG92XS-08	IREGA	Xtra slim ergo super wide opening adjustable wrench		39mm	200mm
PT1803	PLUMTOOL	Wide Opening Slimline Adjustable Wrench		18mm	100mm
PT1817	PLUMTOOL	Wide Opening Slimline Adjustable Wrench		34mm	150mm
PT1809	PLUMTOOL	Wide Opening Slimline Adjustable Wrench		38mm	200mm
PT1814	PLUMTOOL	Wide Opening Slimline Adjustable Wrench		50mm	250mm
ADJUSTABLE WRENCHES - 1000v INSULATED HANDLES:				max opening	length
IG92CP-06	IREGA	1000v insulated adjustable wrench		24mm	150mm
IG92CP-08	IREGA	1000v insulated adjustable wrench		30mm	200mm
IG92CP-10	IREGA	1000v insulated adjustable wrench		34mm	250mm
IG92CP-12	IREGA	1000v insulated adjustable wrench		39mm	300mm



PT8545
Palm Wrench



IG77-08
Drop forged alloy steel
adjustable wrench



DR371CP-10
Chrome plated
adjustable wrench



IG771-30
Drop forged alloy steel
adjustable wrench



IG92WR-06
Reversible jaw wrench



IG92WR-10
Reversible jaw wrench



IG77SWO-08
Super wide opening
adjustable wrench



IG92SWO-08
Ergo grip Super wide
opening adjustable wrench



IG92XS-08
Xtra slim ergo super wide
opening adjustable wrench



IG92XS-04
Xtra Slim Jaw
Adjustable Wrench



PT1809
Wide Opening Slimline
adjustable wrench



IG92CP-10
1000v insulated
adjustable wrench



IG92CP-06
1000v insulated
adjustable wrench

107					
STRAIGHT PIPE WRENCHES:				capacity	length
HTPU200	HIT	Straight pipe wrench - heavy duty		34mm	200mm
HTPU250	HIT	Straight pipe wrench - heavy duty		51mm	250mm
HTPU300	HIT	Straight pipe wrench - heavy duty		58mm	300mm
HTPU450	HIT	Straight pipe wrench - heavy duty		80mm	450mm
HTPU600	HIT	Straight pipe wrench - heavy duty		95mm	600mm
HTPU900	HIT	Straight pipe wrench - heavy duty		132mm	900mm
HTPU1200	HIT	Straight pipe wrench - heavy duty		188mm	1200mm
RO70153	ROTHENBERGER	Drop forge steel - Straight pipe wrench - H/D		60mm	350mm
RO70160	ROTHENBERGER	ALUDUR Drop forged Straight pipe wrench - H/D		60mm	350mm
RO70162	ROTHENBERGER	ALUDUR Drop forged Straight pipe wrench - H/D		89mm	600mm
RO70115	ROTHENBERGER	Offset Aluminium Pipe Wrench - H/D		60mm	350mm
HTALP450	HIT	Light weight aluminium straight pipe wrench		86mm	450mm
HTALP600	HIT	Light weight aluminium straight pipe wrench		105mm	600mm
HTALP900	HIT	Light weight aluminium straight pipe wrench		150mm	900mm
FT431-0041	FULLER	Straight pipe wrench - medium duty			200mm
FT431-0042	FULLER	Straight pipe wrench - medium duty			250mm
FT431-0043	FULLER	Straight pipe wrench - medium duty			350mm
FT431-0044	FULLER	Straight pipe wrench - medium duty			450mm
FT431-0046	FULLER	Straight pipe wrench - medium duty			600mm
FOOTPRINT PATTERN PIPE WRENCHES:				capacity	length
FP900-175	FOOTPRINT	"Thumbturn" Footprint pattern pipe wrench		1.5-38mm	175mm
FP900-225	FOOTPRINT	"Thumbturn" Footprint pattern pipe wrench		3-64mm	225mm
FP900-300	FOOTPRINT	"Thumbturn" Footprint pattern pipe wrench		6-75mm	300mm
SPUD WRENCHES:				capacity	length
HTAOM68	HIT	Compact spud wrench - aluminium		16 - 68mm	200mm
TMRH1924	WORLDWIDE	Ratchet spud wrench		19 x 24mm	310mm
STRAP WRENCHES:				capacity	
HHBW6	HIT	Belt strap wrench		300mm x 150mm	
HTBTW3	HIT	Belt strap wrench		300mm x 75mm	
RO70241	ROTHENBERGER	Strap and fittings wrench		300mm x 220mm cap.	
BOA11022	BOA	Baby Boa constrictor multi purpose wrench		100mm	
BOA12002	BOA	Original Boa constrictor multi purpose wrench		160mm	
BOA13010	BOA	Aluminium Boa constrictor multi purpose wrench		275mm	
CHAIN WRENCHES:					
GO181-10	GRIP-ON	Locking chain wrench		160mm	250mm
RO70244	ROTHENBERGER	HD chain pipe wrench		100mm	
HTCW03	HIT	Chain wrench - forged handle		89mm	290mm
HTCW04	HIT	Chain wrench - forged handle		114mm	390mm
HTCW06	HIT	Chain wrench - forged handle		165mm	490mm
HTCW08	HIT	Chain wrench - forged handle		216mm	670mm
HTCW10	HIT	Chain wrench - forged handle		250mm	710mm



FT431-0043
Straight pipe wrench



HTPU450
Straight pipe wrench



RO70153
Straight pipe wrench



HTALP600
Aluminium adjustable wrench



RO70160
Aluminium pipe wrench



RO70115
Offset Aluminium pipe wrench



TMRH1924
Spud ratchet wrench



FP900-225
Footprint Thumbturn pipe wrench



RO70241
Strap and fittings wrench



HHBW6
Strap wrench



BOA13010
Aluminium Boa constrictor



BOA12002
Original Boa constrictor



BOA11022
Baby Boa constrictor



HTAOM68
Spud wrench



GO181-10
Locking chain wrench



HTCW06
Chain wrench

R/OE COMBINATION SPANNERS:
size

DR542-070	DRAPER	Hi torq R/OE combination spanner	7.0mm
DR542-080	DRAPER	Hi torq R/OE combination spanner	8.0mm
DR542-100	DRAPER	Hi torq R/OE combination spanner	10.0mm
DR542-120	DRAPER	Hi torq R/OE combination spanner	12.0mm
DR542-130	DRAPER	Hi torq R/OE combination spanner	13.0mm
DR542-150	DRAPER	Hi torq R/OE combination spanner	15.0mm
DR542-160	DRAPER	Hi torq R/OE combination spanner	16.0mm
DR542-170	DRAPER	Hi torq R/OE combination spanner	17.0mm
DR542-180	DRAPER	Hi torq R/OE combination spanner	18.0mm
DR542-190	DRAPER	Hi torq R/OE combination spanner	19.0mm
DR542-210	DRAPER	Hi torq R/OE combination spanner	21.0mm
DR542-220	DRAPER	Hi torq R/OE combination spanner	22.0mm
DR542-240	DRAPER	Hi torq R/OE combination spanner	24.0mm
DR542-260	DRAPER	Hi torq R/OE combination spanner	26.0mm
DR542-270	DRAPER	Hi torq R/OE combination spanner	27.0mm
DR542-280	DRAPER	Hi torq R/OE combination spanner	28.0mm
DR542-290	DRAPER	Hi torq R/OE combination spanner	29.0mm
DR542-300	DRAPER	Hi torq R/OE combination spanner	30.0mm
DR542-320	DRAPER	Hi torq R/OE combination spanner	32.0mm

DR542-SET11	DRAPER	Hi torq R/OE combination spanner set <i>sizes: 6, 7, 8, 9, 10, 11, 12, 13, 14, 17, 19mm</i>	11pc
-------------	--------	---	------

RATCHET R/OE COMBINATION SPANNERS AND SETS:
Size

DR310-060	DRAPER	Ratcheting combination spanner	6.0mm
DR310-070	DRAPER	Ratcheting combination spanner	7.0mm
DR310-080	DRAPER	Ratcheting combination spanner	8.0mm
DR310-090	DRAPER	Ratcheting combination spanner	9.0mm
DR310-100	DRAPER	Ratcheting combination spanner	10.0mm
DR310-110	DRAPER	Ratcheting combination spanner	11.0mm
DR310-120	DRAPER	Ratcheting combination spanner	12.0mm
DR310-130	DRAPER	Ratcheting combination spanner	13.0mm
DR310-140	DRAPER	Ratcheting combination spanner	14.0mm
DR310-150	DRAPER	Ratcheting combination spanner	15.0mm
DR310-160	DRAPER	Ratcheting combination spanner	16.0mm
DR310-170	DRAPER	Ratcheting combination spanner	17.0mm
DR310-180	DRAPER	Ratcheting combination spanner	18.0mm
DR310-190	DRAPER	Ratcheting combination spanner	19.0mm
DR310-200	DRAPER	Ratcheting combination spanner	20.0mm
DR310-210	DRAPER	Ratcheting combination spanner	21.0mm
DR310-220	DRAPER	Ratcheting combination spanner	22.0mm
DR310-240	DRAPER	Ratcheting combination spanner	24.0mm
DR310-250	DRAPER	Ratcheting combination spanner	25.0mm
DR310-270	DRAPER	Ratcheting combination spanner	27.0mm
DR310-300	DRAPER	Ratcheting combination spanner	30.0mm
DR310-320	DRAPER	Ratcheting combination spanner	32.0mm
DR310-340	DRAPER	Ratcheting combination spanner	34.0mm

DR310-SET7	DRAPER	Ratcheting combination set (metric) <i>Sizes: 8, 10, 12, 13, 14, 17, 19mm</i>	7pc
------------	--------	---	-----

DR310RV-SET7	DRAPER	Reversible ratcheting combination spanner set (metric) <i>Sizes: 8, 10, 12, 13, 14, 17, 19mm</i>	7pc
--------------	--------	--	-----

AUTOMOTIVE AND ENGINEERING TOOLS:

MA60144	MAYHEW	Dominator curved screwdriver pry bar	425mm
MA60146	MAYHEW	Dominator curved screwdriver pry bar	625mm
MA60148	MAYHEW	Dominator curved screwdriver pry bar	775mm
MA61355	MAYHEW	Dominator curved screwdriver pry bar set of 3	300, 425, 625mm
MA13094	MAYHEW	ProGrip Hook & Pick Set <i>Contains: Straight Pick, Hook, Dual Angle Pick, 90 Degree Bend Pick</i>	set of 4
MA60001	MAYHEW	Dominator HD carbon scraper set	
MA60005	MAYHEW	Weld wakker set of 2	



MA60144
Dominator curved screwdriver bar



MA31981
body forming hammer



MA31999
HD taper punch



MA60001
HD carbon scraper set



MA13094
Progrip Pick and hook set



MA60005
Weld Wakker set



DR310-070
7mm Ratchet comb. spanner



DR310-190
19mm Ratchet comb. spanner



DR310-300
30mm Ratchet comb. spanner



DR542-080
8mm R/OE combination spanner



DR542-190
19mm R/OE combination spanner



DR542-300
30mm R/OE combination spanner



DR542-SET11
R/OE spanner set



DR310-SET7
Ratchet comb. spanner set



DR310RV-SET7
Reversible Ratchet comb. spanner set

1/4" DRIVE SOCKET SETS AND ACCESSORIES:

DRSS-1426	DRAPER	<p>26 piece 1/4" drive ALL metric socket set <i>1/4" SQ to 1/4" Hex adaptor, 1/4" Dr Ratchet handle (72 tooth), 100mm Extension bar, 2x cross slot bits #1, 2, 2x Hex bits 5, 6</i> <i>6x TX-STAR® bits T10, T15, T20, T25, T30, T40</i> 6 Pt sockets: 4, 4.5, 5, 5.5, 6, 7, 8, 9, 10, 11, 12, 13mm</p>
DRSS-1447	DRAPER	<p>47 piece 1/4" drive ALL metric socket set 6 Pt sockets: 4, 4.5, 5, 5.5, 6, 7, 8, 9, 10, 11, 12, 13, 14mm Deep sockets: 6, 7, 8, 9, 10, 11, 12, 13mm, <i>1/4" Dr ratchet handle (72 tooth), spinner handle, Universal joint, 100mm extension bar, 1/4" SQ to 1/4" Hex adaptor</i> 3x plain slot bits: 4, 5.5, 8mm, 3x cross slot bits #1, 2, 3, 6x hex bits: 2, 3, 4, 5, 6, 8mm, 8x Draper TX-STAR® bits T8, T10, T15, T20, T25, T27, T30</p>

3/8" DRIVE SOCKET SETS AND ACCESSORIES:

DRSS-3839	DRAPER	<p>39 piece 3/8" drive METRIC/ AF socket set 6 Pt sockets Metric: 6, 7, 8, 9, 10, 11, 12, 13, 14, 15, 16, 17, 18, 19, 20, 21, 22mm Deep sockets metric: 10, 12, 13mm 6 Pt sockets AF: 1/4", 3/8", 5/16", 7/16", 11/16", 1/2", 9/16", 5/8", 3/4" Spark Plug Sockets: 10, 12, 14mm, 3/8" Dr Ratchet handle (72 tooth) Extension bars: 75mm, 150mm, 300mm, Universal Joint, T-bar head 1/2" (F) x 3/8" (M), 200mm flex handle, T bar head/converter when used with extension bar forms a sliding 'T' bar</p>
-----------	--------	--

1/2" DRIVE SOCKET SETS AND ACCESSORIES:

DRSS-1230	DRAPER	<p>30 Piece 1/2" Dr ALL metric socket set 6 Pt sockets: 8, 9, 10, 11, 12, 13, 14, 15, 16, 17, 18, 19, 20, 21, 22, 23, 24, 25, 26, 27, 28, 30, 32mm 3x spark plug sockets: 10, 12, 14mm, 1/2" Dr ratchet handle (72 tooth), Wobble extension bar size 125mm, Sliding 'T' bar, universal joint</p>	
DRDIS-10	DRAPER	1/2" Drive deep impact socket	10mm
DRDIS-12	DRAPER	1/2" Drive deep impact socket	12mm
DRDIS-13	DRAPER	1/2" Drive deep impact socket	13mm
DRDIS-14	DRAPER	1/2" Drive deep impact socket	14mm
DRDIS-15	DRAPER	1/2" Drive deep impact socket	15mm
DRDIS-16	DRAPER	1/2" Drive deep impact socket	16mm
DRDIS-17	DRAPER	1/2" Drive deep impact socket	17mm
DRDIS-18	DRAPER	1/2" Drive deep impact socket	18mm
DRDIS-19	DRAPER	1/2" Drive deep impact socket	19mm
DRDIS-21	DRAPER	1/2" Drive deep impact socket	21mm
DRDIS-24	DRAPER	1/2" Drive deep impact socket	24mm
DRDIS-30	DRAPER	1/2" Drive deep impact socket	30mm
DRF4730	DRAPER	1/2" Drive 12 point socket	30mm
DRDIS-SET10	DRAPER	<p>10pc 1/2" Drive Metric Deep Impact Socket Set <i>Contains: 10, 12, 13, 14, 15, 17, 19, 22, 24, 27mm</i></p>	
DRDIS-11SET	DRAPER	<p>11pc 1/2" 6 Point Drive metric deep impact socket set <i>Contains: 15, 16, 17, 18, 19, 21, 22, 24, 27, 30, 32mm</i></p>	
DRHD72-12	DRAPER	1/2" Dr reversible cushion grip	
TW-STEPSPAN30	STANWAY	1/2" Drive ratchet and 30mm socket combo	30mm
FT527-8442	FULLER	1/2 Inch Drive Socket Set - 42pc	



DRDIS-10
1/2" Dr 10mm
Deep impact Socket



DRDIS-14
1/2" Dr 14mm
Deep impact Socket



DRDIS-18
1/2" Dr 18mm
Deep impact Socket



DRDIS-24
1/2" Dr 24mm
Deep impact Socket



DRDIS-11SET
1/2" Dr Deep impact Socket Set



DRSS-1447
47 pc 1/4" drive socket set



DRSS-3839
39 pc 3/8" drive socket set



DRDIS-SET10
1/2" Dr Deep impact Socket Set



DRSS-1230
30 pc 1/2" drive socket set



DRSS-1426
26pc 1/4" drive socket set



DRHD72-12
1/2" Dr Ratchet wrench



TW-STEPSPAN30
1/2" Dr Ratchet &
30mm Socket combo



DRF4730
1/2" drive HI-TORQ®
12 Point Socket

110				Height	Width	Depth
TOOLWARE DISPLAY STAND:						
TW-STAND1	Contains:	2 x TW-ST-UPRIGHT 2 x TW-ST-FEET 5 x TW-ST-PANEL 1 x TW-ST-KICKBOARD 1 x TW-ST-BASE		2290mm	1025mm	490mm
	BRANDED HEADERS	Header Board - OPTIONAL		310mm	995mm	120mm
	TW-ST-PANEL	Backboard Panel (1)		400mm	985mm	20mm
	TW-ST-UPRIGHT	Upright Posts (1)		2200mm	30mm	50mm
	TW-ST-BASE	Bottom Base Shelf (1)		40mm	995mm	440mm
	TW-ST-KICKBOARD	Base Kickboard (1)		175mm	980mm	20mm
	TW-ST-FEET	Base Feet (1)		175mm	20mm	440mm
	TW-ST-SHELF	Shelf (1) - OPTIONAL		40mm	995mm	370mm
	TW-ST-BRACKET	Bracket for Optional Shelf (1) - OPTIONAL		135mm		350mm
TW-STAND2		Small free-standing display stand - individual unit only		1620mm	476mm	450mm
BRANDED HEADER DISPLAYS:				Height	Width	Depth
TW-CHANNELLOCK		CHANNELLOCK® Branded header board for TW-STAND1		310mm	995mm	120mm
TW-DRAPER		DRAPER® Branded header board for TW-STAND1		310mm	995mm	120mm
TW-ESTWING		ESTWING® Branded header board for TW-STAND1		310mm	995mm	120mm
TW-GFB		GFB Branded header board for TW-STAND1		310mm	995mm	120mm
TW-GMAN		G-MAN® Branded header board for TW-STAND1		310mm	995mm	120mm
TW-GRIPON-IREGA		GRIP-ON® & IREGA Branded header board for TW-STAND1		310mm	995mm	120mm
TW-HIT		HIT® Branded header board for TW-STAND1		310mm	995mm	120mm
TW-JORGENSEN		JORGENSEN® Branded header board for TW-STAND1		310mm	995mm	120mm
TW-MAYHEW		MAYHEW™ Branded header board for TW-STAND1		310mm	995mm	120mm
TW-MTOWN		MARSHALLTOWN® Branded header board for TW-STAND1		310mm	995mm	120mm
TW-OLFA		OLFA® Branded header board for TW-STAND1		310mm	995mm	120mm
TW-ROTH		ROTHENBERGER® Branded header board for TW-STAND1		310mm	995mm	120mm
TW-STANWAY		STANWAY® Branded header board for TW-STAND1		310mm	995mm	120mm
TW-STARARM		STAR-M® Branded header board for TW-STAND1		310mm	995mm	120mm
TW-STARRETT		STARRETT® Branded header board for TW-STAND1		310mm	995mm	120mm
TW-STEALTHMOUNTS		STEALTHMOUNTS® Branded header board for TW-STAND1		310mm	995mm	120mm
TW-ZIRCON		ZIRCON® Branded header board for TW-STAND1		310mm	995mm	120mm
TW-SMCHAN		CHANNELLOCK® Branded header card for TW-STAND2		155mm	430mm	
TW-SMGFB		GFB Branded header card for TW-STAND2		155mm	430mm	
TW-SMPAN		PANASONIC® Branded header card for TW-STAND2		200mm	460mm	
TW-SMROTH		ROTHENBERGER® Branded header card for TW-STAND2		155mm	430mm	
TW-SMSTEALTH		STEALTHMOUNTS® Branded header card for TW-STAND2		150mm	420mm	
TOOLWARE DISPLAY STAND HOOKS:						Length
TW-ST-P50D	TOOLWARE	Black double prong hook				50mm
TW-ST-P75D	TOOLWARE	Black double prong hook				75mm
TW-ST-P100D	TOOLWARE	Black double prong hook				100mm
TW-ST-P150D	TOOLWARE	Black double prong hook				150mm
TW-ST-P50S	TOOLWARE	Black single prong hook				50mm
TW-ST-P75S	TOOLWARE	Black single prong hook				75mm
TW-ST-P100S	TOOLWARE	Black single prong hook				100mm
TW-ST-P150S	TOOLWARE	Black single prong hook				150mm
TW-ST-P200S	TOOLWARE	Black single prong hook				200mm
TW-ST-P320	TOOLWARE	Shovel display hook - STRAIGHT				300mm
TW-ST-P470	TOOLWARE	Shovel display hook - WATERFALL				350mm
AJP999500	TOOLWARE	EZ Clamp display hook				250mm
OTHER DISPLAY MERCHANDISERS:						Length
TW-BOX1	TOOLWARE	Display Box 1	93mm	103mm		290mm
TW-BOX2	TOOLWARE	Display Box 2	93mm	202mm		290mm
BM-CTBSWV1FP	STEALTHMOUNTS	Countertop Box - to fit 3 products				
BM-CTBV1FP	STEALTHMOUNTS	Single-Width Countertop Box - to fit 1 product				
BM-QPV1FP	STEALTHMOUNTS	Quarter Pallet Display Box - Flat Packed				

TW-STAND1

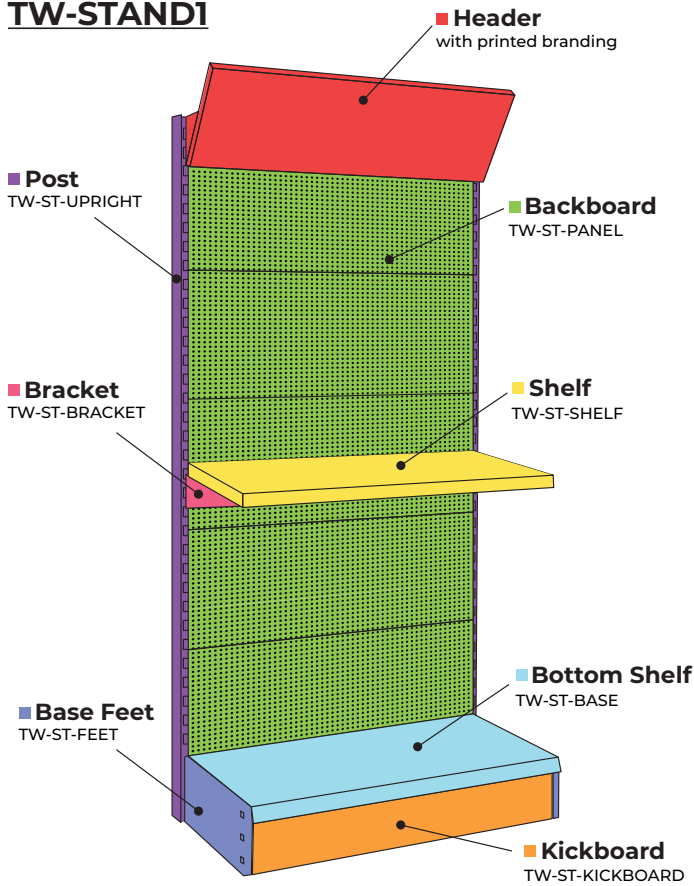

TW-ST-UPRIGHT
Display Stand Post



TW-OLFA
Display Stand Header
BRANDED



TW-ST-PANEL
Display Stand Panel



TW-ST-BRACKET
Bracket for Shelf

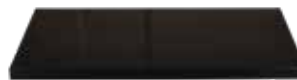

TW-ST-SHELF
Display Stand Shelf



TW-ST-KICKBOARD
Display Stand Kickboard



TW-ST-BASE
Display Stand Base Shelf



TW-ST-FEET
Display Stand Feet



TW-ST-P75S
Single prong hook



TW-ST-P75D
Double prong hook



TW-ST-P320
Shovel display hook
STRAIGHT



TW-ST-P470
Shovel display hook
WATERFALL



AJP999500
Ezi-Clamp display
hook

PLEASE NOTE: ITEMS SHOWN ON DISPLAYS ARE NOT INCLUDED



TW-BOX1 & TW-BOX2
Display boxes



BM-CTBV1FP
Countertop display
holds 3 types



BM-CTBSWV1FP
Countertop display
holds 1 type



BM-QPV1FP
Quarter Pallet Display Box
holds a variety of types