

PRODUCT INFO

HANDYMAN ROUTER BIT SET

6TBUD-12

12_{PC}



DESCRIPTION

The Econocut 12pc Handyman Router Bit Set is a must-have for any handyman or DIY enthusiast. With a set of 12 of the most popular router bits, this affordable yet high-quality kit offers exceptional value. The sturdy timber wooden box provides excellent storage, keeping the bits organized and easily accessible. The rotating bit holder further enhances convenience during use. Featuring an anti-kickback design, these bits prioritize safety. Moreover, all the bits have a 1/4" shank, which is the most popular size for the DIY user. The two flute design ensures a smoother cutting action, making it an ideal choice for precision woodworking projects.

CONTENTS

- 3 x Straight Bits
- 1 x Core Box Bit
- 1 x 14° Dovetail Bit
- 1 x 90° V-Groove Bit
- 1 x Flush Trim Bit with Bearing
- 2 x Rounding Over Bits with Bearing
- 1 x Cove bit with Bearing
- 1 x 45° Chamfering Bit with Bearing
- 1 x Roman Ogee Bit with Bearing
- 1 x Bonus EZE-LAP™ Diamond Hone & Stone Sharpener



BARCODE: 9314657078024

ROUTER BIT SHANK: 1/4"

BOX LENGTH: 200mm

BOX WIDTH: 160mm

BOX DEPTH: 45mm

QUANTITY: 12pc set

WEIGHT: 689g

MEASUREMENTS

HANDYMAN ROUTER BIT SET

6TBUD-12

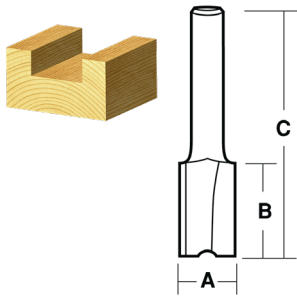

STRAIGHT BIT

SHANK	RADIUS (R)	DIAMETER (A)	CUTTING LENGTH (B)	OVERALL LENGTH (C)	FLUTES	MAX SPEED (RPM)	WEIGHT
1/4" (6.35mm)	---	15/64" (6mm)	5/8" (16mm)	1-7/8" (46.7mm)	2	24000	10g
1/4" (6.35mm)	---	15/32" (12mm)	3/4" (20mm)	2" (52mm)	2	24000	17g
1/4" (6.35mm)	---	5/8" (16mm)	3/4" (20mm)	2" (52mm)	2	24000	25g

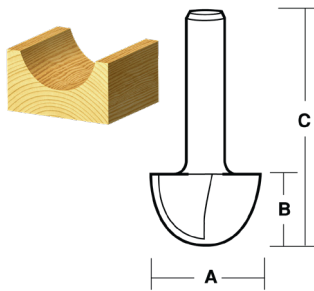

CORE BOX BIT

SHANK	RADIUS (R)	DIAMETER (A)	CUTTING LENGTH (B)	OVERALL LENGTH (C)	FLUTES	MAX SPEED (RPM)	WEIGHT
1/4" (6.35mm)	1/4" (6.35mm)	1/2" (12.7mm)	3/8" (9.5mm)	1-1/2" (40mm)	2	24000	12g

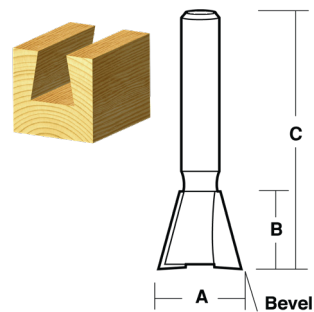

DOVETAIL BIT

SHANK	ANGLE	DIAMETER (A)	CUTTING LENGTH (B)	OVERALL LENGTH (C)	FLUTES	MAX SPEED (RPM)	WEIGHT
1/4" (6.35mm)	14°	1/2" (12.7mm)	15/32" (12mm)	1-3/4" (45mm)	2	24000	12g

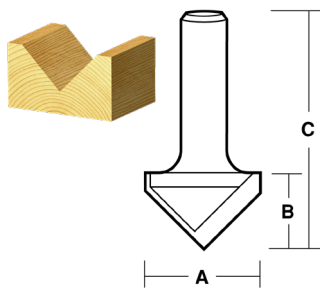

V-GROOVE BIT

SHANK	ANGLE	DIAMETER (A)	CUTTING LENGTH (B)	OVERALL LENGTH (C)	FLUTES	MAX SPEED (RPM)	WEIGHT
1/4" (6.35mm)	90°	1/2" (12.7mm)	1/2" (12.7mm)	1-3/4" (45mm)	2	24000	13g

MEASUREMENTS

HANDYMAN ROUTER BIT SET

6TBUD-12

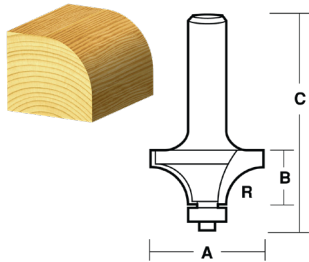

ROUNDING OVER BIT WITH BEARING

SHANK	RADIUS (R)	DIAMETER (A)	CUTTING LENGTH (B)	OVERALL LENGTH (C)	FLUTES	MAX SPEED (RPM)	WEIGHT
1/4" (6.35mm)	1/4" (6.35mm)	7/8" (22mm)	17/32" (13.5mm)	2" (52mm)	2	24000	27g
1/4" (6.35mm)	3/8" (9.5mm)	1-1/8" (28.5mm)	21/32" (16.5mm)	2-3/16" (55.5mm)	2	18000	40g

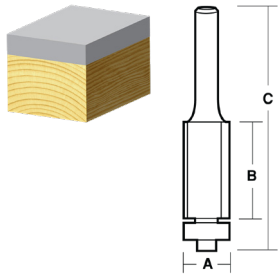

FLUSH TRIM BIT WITH BEARING

SHANK	RADIUS (R)	DIAMETER (A)	CUTTING LENGTH (B)	OVERALL LENGTH (C)	FLUTES	MAX SPEED (RPM)	WEIGHT
1/4" (6.35mm)	---	1/2" (12.7mm)	1/2" (12.7mm)	1-3/4" (45mm)	2	24000	19g

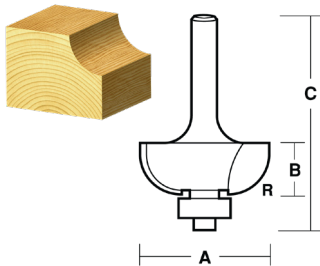

COVE BIT WITH BEARING

SHANK	RADIUS (R)	DIAMETER (A)	CUTTING LENGTH (B)	OVERALL LENGTH (C)	FLUTES	MAX SPEED (RPM)	WEIGHT
1/4" (6.35mm)	1/4" (6.35mm)	7/8" (22mm)	1/2" (12.7mm)	2" (52mm)	2	24000	32g

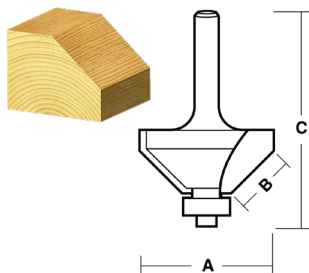

CHAMFERING BIT WITH BEARING

SHANK	RADIUS (R)	DIAMETER (A)	CUTTING LENGTH (B)	OVERALL LENGTH (C)	FLUTES	MAX SPEED (RPM)	WEIGHT
1/4" (6.35mm)	---	1-1/4" (32mm)	19/32" (15mm)	2-3/16" (55.5mm)	2	18000	46g

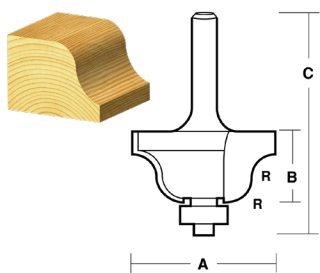

ROMAN OGEE BIT WITH BEARING

SHANK	RADIUS (R)	DIAMETER (A)	CUTTING LENGTH (B)	OVERALL LENGTH (C)	FLUTES	MAX SPEED (RPM)	WEIGHT
1/4" (6.35mm)	4mm	1" (25.5mm)	1/2" (12.7mm)	2" (52mm)	2	24000	32g